

Annex: 11th Call for Proposals (CFP11) - List and Full Description of Topics

Call Text

R1 [V1]

- 21 November 2019 -

The present preliminary version of the Call Text is released for information and addressed to any interested party prior to the official launch of the Call anticipated in January 2020. The final call text document serving as the foundation for any application to this Call and Q&A will be published via the H2020 Funding & Tender Opportunities Portal of the European Commission. The content is a non-legally binding preliminary version and may still be subject to modifications until its official publication.



Important notice on Q&As

Question and Answers will open as from the Call Opening date i.e. on or soon after 14 January 2020 via the Funding & Tender Opportunities Portal of the European Commission.

In case of questions on the Call (either administrative or technical), applicants are invited to contact the JU using the **dedicated Call functional mailbox**: *email address available as from the official Call Launch*.

Note that questions received **up until 13/03/2020, 17:00 (Brussels Time)** will be answered after analysis and published in Q&A when appropriate. In total, three publications of Q/As are foreseen: 14/01/2020, 20/02/2020 and 26/03/2020 (estimated dates).

The Q/As will be made available via the H2020 Funding & Tender Opportunities Portal of the European Commission.

CfP11 Information Days (Main and Local info days): January and February 2020.

More Information available on the Call and events on the Clean Sky 2 website: www.cleansky.eu



INDEX

PART A: Call topics launched within the complementary framework of IADP/ITD/TA 7

1.	Overview of number of topics and total indicative funding value per SPD	7
2.	Call Rules	7
3.	Programme Scene setter/Objectives	8
4.	Clean Sky 2 – Large Passenger Aircraft IAPD.....	10
5.	Clean Sky 2 – Regional IADP	116
7.	Clean Sky 2 – Airframe ITD	125
9.	Clean Sky 2 – Systems ITD	151

PART B: Thematic Topics203

1.	Overview of Thematic Topics	203
2.	Call Rules	203
3.	Programme Scene setter/Objectives	204
4.	Clean Sky 2 – Thematic Topics	206

List of Topics for Calls for Proposals (CFP11) – Part A

Identification Code	Title	Type of Action	Value (Funding in M€)	Topic Leader
JTI-CS2-2020-CfP11-LPA-01-88	Development of New digital Microphone-MEMS-Sensors for wind tunnels with open/closed test sections and flight tests	IA	1.40	Airbus
JTI-CS2-2020-CfP11-LPA-01-89	Advanced characterization of friction and surface damage for gears running in loss of lubrication conditions	RIA	1.10	GE Avio
JTI-CS2-2020-CfP11-LPA-01-90	Automated thermography for inspection of welded safety critical engine components	IA	0.70	GKN
JTI-CS2-2020-CfP11-LPA-01-91	Development and validation of a method to predict non-linear aerodynamic characteristics of lifting surfaces with controls	RIA	0.75	Airbus
JTI-CS2-2020-CfP11-LPA-01-92	Optimization of APU Exhaust Muffler Thermal Barrier and Air Intakes construction Technologies	IA	0.90	Airbus
JTI-CS2-2020-CfP11-LPA-01-93	Engine bleed jet pumps continuous behaviour modelization	RIA	0.70	Liebherr
JTI-CS2-2020-CfP11-LPA-01-94	Installed UHBR Nacelle Off-Design Performance Characteristics.	RIA	3.00	Rolls-Royce
JTI-CS2-2020-CfP11-LPA-01-95	Passive Actuated Inlet for UHBR engine ventilation	IA	0.80	Airbus
JTI-CS2-2020-CfP11-LPA-01-96	Analytical and experimental characterization of aerodynamic and aeroacoustic effects of closely operating propellers for distributed propulsion wing solutions.	RIA	2.50	Airbus Defence and Space
JTI-CS2-2020-CfP11-LPA-01-97	Insulation Monitoring for IT Grounded (Isolation Terra) Aerospace Electrical Systems	IA	0.70	Rolls-Royce plc
JTI-CS2-2020-CfP11-LPA-02-33	Tooling, Equipment and Auxiliaries for the closure of a longitudinal Barrel Joint: Butt strap integration and Lightning Strike Protection continuity	IA	1.60	Airbus
JTI-CS2-2020-CfP11-LPA-02-34	Tooling, Equipment and Auxiliaries for the closure of a longitudinal Barrel Joint: Overlap joint and Frame Coupling integration	IA	1.40	Airbus
JTI-CS2-2020-CfP11-LPA-02-35	Innovative disbond arrest features for long thermoplastic welded joints	IA	0.75	Fokker
JTI-CS2-2020-CfP11-LPA-02-36	Large scale aircraft composite structures recycling [ECO]	IA	1.80	Airbus
JTI-CS2-2020-CfP11-LPA-02-37	Thermoplastic fuselage repair process integrated on manufacturing line	IA	0.80	Airbus
JTI-CS2-2020-CFP11-LPA-03-19	Concept for Pilot State Monitoring system operation in commercial aviation	IA	0.80	Honeywell International
JTI-CS2-2020-CFP11-LPA: 16 topics			19.70	

Identification Code	Title	Type of Action	Value (Funding in M€)	Topic Leader
JTI-CS2-2020-CFP11-REG-01-20	Aerodynamics experimental characterization and new experimental testing methodologies for distributed electrical propulsion	RIA	0.80	Centro Italiano Ricerca Aerospaziale
JTI-CS2-2020-CFP11-REG: 1 topic			0.80	
JTI-CS2-2020-CFP11-AIR-01-46	Evaluation of NDT Techniques for Assessment of Critical Process and Manufacturing Related Flaws and Defects for a Ti-alloy	RIA	0.55	SAAB
JTI-CS2-2020-CFP11-AIR-01-47	Additive Manufacturing demonstration on test article for a trailing edge application with a sliding pad concept	IA	0.50	ASCO Industries
JTI-CS2-2020-CFP11-AIR-03-10	Innovative light metallic and thermoplastic airframe section full scale testing	IA	1.30	Hellenic Aerospace Industries
JTI-CS2-2020-CFP11-AIR-03-11	Development and execution of new test methods for thermoset panel manufactured in an automated tape layup of dry unidirectional fibres (UD) or non-crimped fabrics (NCF) and subsequent infusion	IA	0.50	University of Stuttgart
JTI-CS2-2020-CFP11-AIR: 4 topics			2.85	
JTI-CS2-2020-CFP11-SYS-01-22	Oxygen Absorbing Metal-Air-Batteries for Long Term Cargo Compartment Inertisation	RIA	0.80	Diehl Aviation Gilching GmbH
JTI-CS2-2020-CFP11-SYS-01-23	Development of a multi-position valve with associated actuator for cargo fire protection	IA	0.50	Safran
JTI-CS2-2020-CFP11-SYS-02-62	Thermoplastic wheel for electrical Environmental Control System	IA	0.75	Liebherr
JTI-CS2-2020-CFP11-SYS-02-63	Decentralised HVDC power conversion module for innovative optimised aircraft electrical network distribution	IA	0.75	Airbus
JTI-CS2-2020-CFP11-SYS-02-64	Human Safe HVDC Interconnection components	IA	0.80	Airbus
JTI-CS2-2020-CFP11-SYS-03-25	Investigation and modelling of hydrogen effusion in electrochemically plated ultra-high-strength-steels used for landing gear structures	RIA	1.00	Liebherr
JTI-CS2-2020-CFP11-SYS-03-26	Replacement of cobalt in Environmental Control System bleed valves	IA	0.75	Liebherr
JTI-CS2-2020-CFP11-SYS: 7 topics			5.35	
JTI-CS2-2020-CFP11-TE2-01-12	Airport level assessments for fixed wing aircraft	RIA	0.50	DLR
JTI-CS2-2020-CFP11-TE2-01-13	Airport and ATS Level Assessment for Rotorcraft	RIA	0.50	DLR
JTI-CS2-2020-CFP11-TE2-01-14	Reduction of the environmental impact of aviation via optimisation of aircraft size/range and flight network	RIA	0.50	DLR
JTI-CS2-2020-CFP11-TE: 3 topics			1.50	

List of Topics for Calls for Proposals (CFP11) – Part B

Identification Code	Title	Type of Action	Value (Funding in M€)
JTI-CS2-2020-CFP11-THT-11	High power density/multifunctional electrical energy storage solutions for aeronautic applications	RIA	1.20
JTI-CS2-2020-CFP11-THT-12	Advanced High Power Electrical Systems for High Altitude Operation	RIA	1.00
JTI-CS2-2020-CFP11-THT-13	Sustainability of Hybrid-Electric Aircraft System Architectures	RIA	1.60
JTI-CS2-2020-CFP11-THT-14	Scalability and limitations of Hybrid Electric concepts up to large commercial aircraft	RIA	0.80

PART A: Call topics launched within the complementary framework of IADP/ITD/TA

1. Overview of number of topics and total indicative funding value per SPD

SPD Area	No. of topics	Ind. topic Funding (in M€)
IADP Large Passenger Aircraft	16	19.70
IADP Regional Aircraft	1	0.80
IADP Fast Rotorcraft	0	0
ITD Airframe	4	2.85
ITD Engines	0	0
ITD Systems	7	5.35
Small Air Transport related topics		
ECO Design related topics		
Technology Evaluator	3	1.50
<u>TOTAL</u>	<u>31</u>	<u>30.20</u>

2. Call Rules

Before submitting any proposals to the topics proposed in the Clean Sky 2 Call for Proposals, all applicants shall refer to the applicable rules as presented in the “Bi-annual Work Plan 2020-2021” and the “Rules for submission, evaluation, selection, award and review procedures of Calls for Proposals”¹.

The following additional conditions apply to the calls for proposals launched within the complementary framework of one IADP/ITD/TA:

1. In the light of the specific structure of the programme and the governance framework of the JU, the specific legal status and statutory entitlements of the “members” of the JU and in order to prevent any conflict of interest and to ensure a competitive, transparent and fair process, the following "additional conditions" in accordance with Article 9.5 of the H2020 Rules for Participation:
 - **The 16 Leaders of JU listed in Annex II to Regulation n° (EU) No 558/2014 and their affiliates² may apply to Calls for Proposals only in another IADP/ITD where they are not**

¹ These documents are accessible via the Funding and Tender Opportunities Portal.

² See the definition under Article 2.1(2) of the H2020 Rules for Participation



involved as Members.

- **The Core partners and their affiliates** may apply to calls for proposals only in another IADP/ITD where they are not involved as member.

2. Applicants may apply to calls for proposals if they:

- officially state whether they are an affiliate³ to a member of the JU or not;
- Issue a declaration of absence of conflicts of interest⁴.

These elements shall determine the admissibility of the proposal.

The above additional conditions and the declarations will be checked by the JU which will determine the admissibility of the proposals. The CS2JU reserves its right to request any supporting document and additional information at any stage of the process.

Please note that proposals may include the commitment from the European Aviation Safety Agency (EASA) to assist or to participate in the action without EASA being eligible for funding.

Please note that the provisions under the chapters on “Special skills, Capabilities, Certification expected from the Applicant(s)” do not constitute additional conditions for participation according to Art. 9(5) H2020 Rules for Participation.

3. Programme Scene setter/Objectives

In accordance with Article 2 of the COUNCIL REGULATION (EU) No 558/2014 of 6 May 2014⁵ the **Clean Sky 2 high-level (environmental) objectives are:**

“(b) to contribute to improving the environmental impact of aeronautical technologies, including those relating to small aviation, as well as to developing a strong and globally competitive aeronautical industry and supply chain in Europe.

This can be realised through speeding up the development of cleaner air transport technologies for earliest possible deployment, and in particular the integration, demonstration and validation of technologies capable of:

- (i) increasing aircraft fuel efficiency, thus reducing CO₂ emissions by 20 to 30 % compared to ‘state-of-the-art’ aircraft entering into service as from 2014;*
- (ii) reducing aircraft NO_x and noise emissions by 20 to 30 % compared to ‘state-of-the-art’ aircraft entering into service as from 2014.”*

These Programme's high-level (environmental) objectives have been translated into **targeted vehicle performance levels**, see table below. Each conceptual aircraft summarises the key enabling technologies, including engines, developed in Clean Sky 2.

³ See the definition under Article 2.1(2) of the H2020 Rules for Participation

⁴ As part of the declaration, the legally authorized representative of the applicants entities will be requested to declare whether the representative(s) of the entity participate to the IADP/ITD steering committees and whether they representative(s) of the entity was involved in the preparation, definition and approval of the topics of the calls or had any privileged access information related to that.

⁵ OJ L 169, 7.6.2014, p.77

Conceptual aircraft / air transport type	Reference a/c*	Window ¹	ΔCO_2	ΔNO_x	Δ Noise	Target ² TRL @ CS2 close
Advanced Long-range (LR)	LR 2014 ref	2030	20%	20%	20%	4
Ultra advanced LR	LR 2014 ref	2035+	30%	30%	30%	3
Advanced Short/Medium-range (SMR)	SMR 2014 ref	2030	20%	20%	20%	5
Ultra-advanced SMR	SMR 2014 ref	2035+	30%	30%	30%	4
Innovative Turboprop (TP), 130 pax	2014 130 pax ref	2035+	19 to 25%	19 to 25%	20 to 30%	4
Advanced TP, 90 pax	2014 TP ref ⁴	2025+	35 to 40%	> 50%	60 to 70%	5
Regional Multimission TP, 70 pax	2014 Multi-mission	2025+	20 to 30%	20 to 30%	20 to 30%	6
19-pax Commuter	2014 19 pax a/c	2025	20%	20%	20%	4-5
Low Sweep Business Jet	2014 SoA Business a/c	2035	> 30%	> 30%	> 30%	\geq 4
Compound helicopter ³	TEM 2020 ref (CS1)	2030	20%	20%	20%	6
Next-Generation Tiltrotor	AW139	2025	50%	14%	30%	5

*The reference aircraft will be further specified and confirmed through the Technology Evaluator assessment work.

1 All key enabling technologies at TRL 6 with a potential entry into service five years later.

2 Key enabling technologies at major system level. The target TRL indicates the level of maturity and the level of challenge in maturing towards potential uptake into marketable innovations.

3 Assessment v. comparable passenger journey, not a/c mission.

4 ATR 72 airplane, latest SOA Regional A/C in-service in 2014 (technological standard of years 2000), scaled to 90 Pax.

To integrate, demonstrate and validate the most promising technologies capable of contributing to the CS2 high-level and programme specific objectives, the CS2 technology and demonstration activity is structured in **key (technology) themes**, further subdivided in a number of **demonstration areas**, as depicted below. A demonstration area may contribute to one or more objectives and also may involve more than one ITD/IADP.

Ref-Code	Theme	Demonstration area
1A	Breakthroughs in Propulsion Efficiency (incl. Propulsion-Airframe Integration)	Advanced Engine/Airframe Architectures
1B		Ultra-high Bypass and High Propulsive Efficiency Geared Turbofans
1C		Hybrid Electric Propulsion
1D		Boundary Layer Ingestion
1E		Small Aircraft, Regional and Business Aviation Turboprop
2A	Advances in Wings, Aerodynamics and Flight Dynamics	Advanced Laminar Flow Technologies
2B		Regional Aircraft Wing Optimization
3A	Innovative Structural / Functional Design - and Production System	Advanced Manufacturing
3B		Cabin & Fuselage
3C		Innovative Solutions for Business Jets
4A	Next Generation Cockpit Systems and Aircraft Operations	Cockpit & Avionics
4B		Advanced MRO
5A	Novel Aircraft Configurations and Capabilities	Next-Generation Civil Tiltrotor
5B		RACER Compound Helicopter
6A	Aircraft Non-Propulsive Energy and Control Systems	Electrical Systems
6B		Landing Systems
6C		Non-Propulsive Energy Optimization for Large Aircraft
7A	Optimal Cabin and Passenger Environment	Environmental Control System
7B		Innovative Cabin Passenger/Payload Systems
8A	Eco-Design	
9A	Enabling Technologies	
	Technology Evaluator	

The individual topic descriptions provide more detailed information about the link/contribution to the high-level objectives.

4. Clean Sky 2 – Large Passenger Aircraft IAPD

I. JTI-CS2-2020-CfP11-LPA-01-88: Development of New digital Microphone-MEMS-Sensors for wind tunnels with open/closed test sections and flight tests

Type of action (RIA/IA/CSA):		IA	
Programme Area:		LPA	
(CS2 JTP 2015) WP Ref.:		WP 1.1	
Indicative Funding Topic Value (in k€):		1400	
Topic Leader:	Airbus	Type of Agreement:	Implementation Agreement
Duration of the action (in Months):	30	Indicative Start Date (at the earliest)⁶:	> Q4 2020

Topic Identification Code	Title
JTI-CS2-2020-CfP11-LPA-01-88	Development of New digital Microphone-MEMS-Sensors for wind tunnels with open/closed test sections and flight tests
Short description	
<p>The main objective is to develop a novel technology for surface unsteady pressure measurements which are suitable for arbitrary model/aircraft position (including cockpit area) and with high spatial resolution. State of the art microphones are too large to capture the unsteady pressure fluctuations underneath the turbulent boundary layer to predict the cabin noise excitation (especially in regions with high pressure gradients). MEMS sensors seem to be a good candidate to overcome. State of the art microphones limitations. This topic aims at developing new digital MEMS based microphones fulfilling acoustic requirements for wind-tunnels and flight test applications.</p>	

Links to the Clean Sky 2 Programme High-level Objectives ⁷				
This topic is located in the demonstration area:		Advanced Engine/Airframe Architectures		
The outcome of the project will mainly contribute to the following conceptual aircraft/air transport type as presented in the scene setter:		Advanced Long-range Ultra-advanced Long-range Advanced Short/Medium-range Ultra-advanced Short/Medium-range		
With expected impacts related to the Programme high-level objectives:				
Reducing CO ₂ emissions	Reducing NO _x emissions	Reducing Noise emissions	Improving EU Competitiveness	Improving Mobility
<input type="checkbox"/>	<input type="checkbox"/>	<input checked="" type="checkbox"/>	<input checked="" type="checkbox"/>	<input type="checkbox"/>

⁶ The start date corresponds to actual start date with all legal documents in place.

⁷ For further info see Chapter 1 "Introduction to the Programme Scene Setter / Objectives" with key technology themes / demonstration areas. Detailed information available in the CS2 Development Plan accessible via the Clean Sky JU Website and EC Participant Portal.

1. Background

Complying with community noise certification rules and cabin noise guarantees while minimizing the impact on aircraft weight and efficiency is a key objective for people working in the acoustic domain at a time where environmental requirements are continuously stringing. In this context, accurate prediction means are necessary to develop well-sized acoustic design solutions. Although significant progress were made by Airbus in the past years in terms of numerical acoustic modeling capabilities, some important and complex phenomena at aircraft and engine levels can so far only be tackled by experiments. Moreover, the models used and their inputs are mostly based on test data coming from wind-tunnel and flight tests.

During these tests, a large amount of acoustic instrumentation is installed but the current classical microphones suffer from several drawbacks:

- The height of current microphone is too important generating self-noise of the sensor itself mainly in the low-frequency area.
- The size of current microphone is too large preventing accurate cross-spectral measurement in high frequency and a representative measurement of the turbulent boundary layer.
- The price of the sensor preventing a significant increase of sensors which could allow capturing more added-value data and feeding big data approach.

To overpass these limitations, MEMS microphones seem to be a good candidate as these sensors are cheap and have a high amplitude and phase accuracy as shown in Figure 1. Moreover, these sensors can be easily integrated in soft support which can be easily glued on the aircraft (see Figure 2).

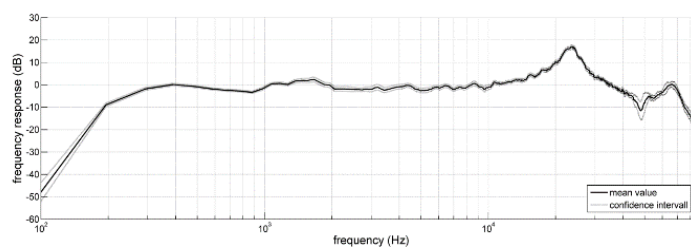

Figure 1: Typical deviation of frequency response of numerous MEMS sensors



Figure 2: Example of microphone array containing 64 sensors.

Nevertheless, the state of the art MEMS microphones have limitations which need to be overcome:

- The maximum sound pressure level which is quite low with respect to the targeted application.
- The sensor dynamics has to be increased (if possible).
- The analogical / numerical conversion has to be done as close as possible from the sensors.
- The sensor integration within the electrical circuit board has to be simple and robust
- Once these sensors are integrated, the phase shift between sensors has to be characterised.

It is then proposed to study and develop a new acoustic sensor based on MEMS technology which will fulfill the requirement expressed in Section 2.2.

2. Scope of work

2.1. Objectives

The improvement objectives sought in this topic is the development of a new miniaturized digital MEMS-Sensors microphone dedicated to accurate acoustic measurements during wind-tunnel and flight tests which will allow:

- Increasing the spatial resolution of microphone arrays by reducing the diameter of the microphone membrane.
- Increasing the sensitivity of the microphone to small-scaled pressure fluctuations (e.g. better measurements of turbulent boundary layer component) by reducing the diameter of the membrane.
- Extending the application area and the optimization of microphone array for improving low-noise aircraft design assessment by reducing the cost of one sensor.
- Reducing flight test cost by developing a quick integrated system.

Depending on the feasibility, either one solution addressing both WTT and FT requirements or different MEMS sensors could be proposed for each application.

The objective of this topic is to mature the development of sensors up to TRL6.

This(ese) microphone(s) will have to be in line with the targeted requirements expressed hereafter.

2.2. MEMS sensor requirements

The following requirements exposed here after are to be considered as the targeted requirements. Nevertheless, especially when considering the high ambition of these, the applicant(s) are requested to provide their best envisaged solution (as close as possible to the targets), with identification and explanations about limitations in case of failure to meet the proposed targets.

To secure the execution of the project, it is proposed to proceed in 2 stages: to start with the less demanding design, compatible wind-tunnel test application and to continue in a second step to with the one compatible with flight test application.

2.2.1 Characterisitcs definitions

All comments are with reference to sensors for wind tunnels with open/closed test sections and flight tests. Unless otherwise stated, only dynamic pressure sensors are considered.

Costs [€/unit]: For measurements in all three environments, the number of sensors is high (100 to 500 and more). Thus, the costs should be as low as possible (a good target should be < 10€/unit). The costs also include the durability in terms of robustness to the sensor handling, the robustness to the expose to overloads and the uncertainty of manufacture (quality of different charges).

Sensitivity [V/Pa]: The sensitivity is ratio of the analogue output voltage (or the percent of the full scale output of digital sensors) to the input pressure. As a rule of thumb, a high sensitivity (around several 100 mV/Pa and more) is better suited in environments with low and medium sound pressure levels whereas lower sensitivities (around several mV/Pa) are better suited for high noise environments to avoid clipping and distortion. Clipping and distortion are considered by the upper dynamic range limitation. Thus the sensitivity is of less importance and is influenced by the dynamic range, the signal to noise ratio and the general microphone type.

Dynamic Range [dB]: the dynamic range is defined by the upper boundary, the **Maximum signal level** and the lower boundary, the **Noise floor level**. The maximum signal level is most important and defines up to which sound power level (SPL) the sensor responds linear and shows no clipping which causes

distortion. In general the maximum signal level is given by a sound power level value given at a certain total harmonic distortion (THD) level (usually from 1% to 10%). For our applications in general a THD of up to 3% can be accepted at very high levels. The needed noise floor level is defined by the lowest level one wants to measure. It should be considerably below the background noise level in the utilized environment. The values in the tables are based on integrated rms-value in linear dB.

Signal to Noise ratio [dB]: The SNR is the difference between the noise floor level and the 94 dB SPL reference. It is not equivalent to the dynamic range. By a wider definition it is the difference between a given signal and the resulting noise floor. The SNR should be large enough to cover all signals of interest below a maximum level. Deviating from the 94 dB SPL reference we need to look for the SNR based on a higher level based on the application. This is because of the high noise floor level of high level sensors which causes are underestimated SNR if based on the 94 dB SPL.

Frequency response: The frequency response describes the output level across the frequency spectrum, often normalized to 0 dB at 1 kHz. The manufacturer often gives the Linear Frequency range, where the maximum deviation from a flat response is a specific maximum (+/- 1 dB to 3 dB). The needed frequency range is given by the application (in this case the utilized environment: WT open/closed, flight test).

Microphones with a flat response up to very high frequencies (100 kHz, closed test section application) are expensive. Thus often cheaper sensors are used, where the frequency response drop over e.g. 20 kHz can usually be corrected in the calculation. Here, for example a roll-off above the upper limit of a 20 kHz flat response of -12 dB per octave can be accepted.

Field Type: For precision condenser microphones here a two types of interest for our applications. Pressure field microphones measure the sound pressure in front of the diaphragm. They are recommended for measuring in enclosures, cavities and on walls. For our applications they are recommended for the use as wall-mounted microphones in the closed test section or on the airplanes surface in a flight test. Free-field microphones measure the sound pressure at the diaphragm and correct the sound pressure of an incoming wave (0° incidence) as if the microphone is not present. They are for use in anechoic chambers, or in larger open areas where free-field conditions can be assumed. For our applications they are recommended for measuring in wind tunnels with an open test section, where the test section is embedded in an anechoic chamber.

For small sensors, such as MEMS microphones, the field type is of less importance due to the negligible interaction of the sensor with the acoustic waves. This is restricted to wavelengths significantly larger (app. 4 times) than the sensor measures. Here these sensors have approximately an omnidirectional directivity.

Phase accuracy: The phase accuracy between sensors is of highest importance. The individual phase response to a reference can be quantified by measurements and then be considered in the analysis. Nevertheless, small standard deviations of all individual phase responses are preferable.

Further requirements: Depended on the application here are more important requirements. They are briefly summarized in the following. If a requirement is of high importance for the application on wind tunnels with open test sections, on wind tunnels with closed test section or on flight tests, it will be further detailed in the corresponding chapter.

- Stability to temperature / static pressure
- Microphone dimensions
 - o Height (Installation issues)
 - o Diameter
 - o Sensitive Surface
- Mounting: For microphones exposed to the wind the mounting influences the wind induced self noise, the separation between acoustic and boundary layer and the correlation of the acoustic signals between the microphones. Therefor bottom port MEMS microphones are preferred. The pinhole (sound channel) should be short to avoid acoustic resonances.
- Robustness to external noise

- PSRR (power supply rejection ratio)
- EMS (electromagnetic) noise rejection
- Weather resistance (flight)
 - Temperature/humidity constraints
 - Time stability
- Physical robustness
 - Of handling
 - to overloads
- Cables and Connectors
 - Resistance to environmental disturbances
 - Cable shielding
- Vibrational sensitivity
- Position of pressure equalization vent
- Output format (analogue, digital (data format, spectra, time, etc.))

Important note: Even if all above stated requirements are fulfilled, most important is the cross correlation of the “wanted signal” between the sensors under real operating conditions of industrial equipment. Here, next to the robustness to external noise etc. the interaction between the mounting concept and the sensor itself is qualified.

2.2.2 Sensor specifications

2.2.2.1 General requirements

Criterion		Wind tunnel test application <i>Open test section</i>	Wind tunnel test application <i>Closed test section</i>	Fligh test application
Airframe noise application Dynamic Range [linear dB ref. $2 \cdot 10^{-5}$ Pa] (integrated rms value)	Min	0	30	45
	Max	140	150	145
Rotor/Fan noise application Dynamic Range [linear dB ref. $2 \cdot 10^{-5}$ Pa] (integrated rms value)	Min	30	30	45
	Max	170	170	175
Frequency Response [Hz] (see footnote 8 and remarks)	+/- 3 dB	100 – 35000	100 – 100000	40 - 10000
	-12dB/oct. ⁸	500 – 50000	n/a	n/a
Signal to Noise ratio below 120 dB [dB]		90	90	70
Temperature range [°C]	Min	-50	-20	-65
	Max	70	70	30
Ambient pressure stability range [Pa] ⁹	Min	99000	99000	22000
	Max	102000	102000 (not pressurized) 500000 (pressurized)	102000

⁸ Roll-off above the upper limit of a 20 kHz flat response.

⁹ For measurements in closed test sections with additional static pressure, see section **Error! Reference source not found.**

Criterion		Wind tunnel test application <i>Open test section</i>	Wind tunnel test application <i>Closed test section</i>	Fligh test application
Humidity stability range [%]	Max	50	50	Up to 100%
Pressure equilization vent		Individual front vented	Individual front vented	
Environment statbility				Water proof / ice / cloud
Thickness / Height		1 mm	1 mm	1 mm
Extra requirements:				

Pressurized tunnel:

If the sensor should be used in wind tunnels with a pressurized test section (Reynolds number), an additional resistance of up to additional 5 kPa should be taken into account. It should be noted that this has got a significant influence on the frequency response.

2.2.2.2 Extra requirements for wind-tunnel test

General microphone type: Because of the wall mounting it should be a pressure field sensor.

Height: if used inside a array frame, limits the minimum thickness of the array (max. 2mm)

Diameter: limits the minimum distance between microphones (max. 10 mm)

Mounting:

Pressure resistance: If the sensor should be used in pressurized environments, an additional resistance of up to additional 5 kPa should be taken into account. It should be noted that this has got a significant influence on the frequency response.

Physical robustness: resistance to damage caused by shock etc. caused by transport of the array

Seeding: The sensor should be physical robust to standard PIV seeding particles (DEHS, soap bubbles)

2.2.2.3 Extra requirements for flight test

Diameter: limits the minimum distance between microphones (max 5-10mm);

Mounting: influences strongly the separation from boundary layer and the cross-correlation between the microphones

Physical robustness: resistance to damage caused during exterior installation and to harsh conditions present during flight test: very high subsonic speeds, rainfall, and the possibility of ice formation

Cable shielding: Cables must be shielded off from electric noises possibly caused due to the power supply on board the airplane or other electric systems

Sensitive Surface: The expected size of the pressure fluctuations in the boundary layer is small. Therefore the sensitive surface is to be reduced to a minimum by appropriate measures.

2.3. Sensors integration

Once this new MEMS sensor will be developed, the integration of these sensors on electronics circuit have to be looked at. Indeed, electronics integration could induce phase shift between sensors which has to be eradicated in order to perform valuable cross-spectra measurements. All the performance deviations linked to the integration on electronics circuit have to be minimized and assessed.

2.4. Sensor qualification

Once the sensor will be developed and integrated, the main characteristics of the sensors and its

integration will have to be demonstrated first during laboratory tests and then on real applications. For wind-tunnel tests and flight tests, some specific slots could be proposed by the topic manager to execute these tests. The consortium will have just to ensure the support for these tests and to take into account the constraints coming from such tests.

For the validation, the protocol will have to be discussed and agreed with the topic manager.

3. Major Deliverables/ Milestones and schedule (estimate)

*Type: R= Report, RM= Review Meeting, D=Data, HW=Hardware

Deliverables			
Ref. No.	Title - Description	Type*	Due Date
Step 1: Wind tunnel (WT) test application			
01	Partner contribution detailed description (content, deliverables, planning)	Report	T0 + 3
02	Final specifications of the WT sensor	Report + Decision gate	T0 + 3
03	Choice of the solution for WT and validation plan	Report + Decision gate	T0 + 6
04	MEMS prototype for WT sensor	Specimens	T0 + 10
05	Validation of the WT sensor in laboratory conditions	Test Report + compliance	T0 + 12
06	Validation of the sensor in wind-tunnel conditions	Test Report + compliance	T0 + 18
Step 2: Flight test (FT) application			
07	Final specifications of the FT sensor taking into account results from laboratory tests	Report + Decision gate	T0 + 18
08	Choice of the solution (unique or several) and validation plan	Report + Decision gate	T0 + 20
09	MEMS prototype for FT sensor	Specimens	T0 + 22
10	Validation of the FT sensor in laboratory conditions	Test Report + compliance	T0 + 26
11	Validation of the sensor in flight tests conditions	Test Report + compliance	T0 + 28
Final deliverable			
12	Final MEMS sensor(s) design ready to industrialize (TRL6)	Report + specimen	T0 + 30

4. Special skills, Capabilities, Certification expected from the Applicant(s)

Essential: sound technical knowledge in the following areas:

- Electronics
- MEMS acoustic sensor
- Acoustics measurements

5. Abbreviations

MEMS	Micro-Electro-Mechanical Systems
TBL	Turbulent Boundary Layer
WTT	Wind Tunnel Test
FTD	Flight Test demonstration

II. JTI-CS2-2020-CfP11-LPA-01-89: Advanced characterization of friction and surface damage for gears running in loss of lubrication conditions

Type of action (RIA/IA/CSA):		RIA	
Programme Area:		LPA	
(CS2 JTP 2015) WP Ref.:		WP 1.1	
Indicative Funding Topic Value (in k€):		1100	
Topic Leader:	GE Avio	Type of Agreement:	Implementation Agreement
Duration of the action (in Months):	30	Indicative Start Date (at the earliest)¹⁰:	> Q4 2020

Topic Identification Code	Title
JTI-CS2-2020-CfP11-LPA-01-89	Advanced characterization of friction and surface damage for gears running in loss of lubrication conditions

Short description
The optimization of the lube system and sump layout in next generation geared turbofans is key to reduce weight and complexity, while ensuring reliability. This topic aims at maturing up to TRL3 configurations in which the auxiliary or secondary oil system is not necessary to survive off-design requirements. It is requested to investigate the major drivers of frictional heating and surface damage on gears running in off-design conditions, to identify solutions providing abatement to the risk of damage on gear surfaces and to demonstrate such technologies and solutions on component test, such as power circulating rigs, running in representative aeroengine conditions.

Links to the Clean Sky 2 Programme High-level Objectives ¹¹				
This topic is located in the demonstration area:		Ultra-high Bypass and High Propulsive Efficiency Geared Turbofans		
The outcome of the project will mainly contribute to the following conceptual aircraft/air transport type as presented in the scene setter:		Advanced Short/Medium-range		
With expected impacts related to the Programme high-level objectives:				
Reducing CO ₂ emissions	Reducing NO _x emissions	Reducing Noise emissions	Improving EU Competitiveness	Improving Mobility
<input checked="" type="checkbox"/>	<input type="checkbox"/>	<input type="checkbox"/>	<input checked="" type="checkbox"/>	<input type="checkbox"/>

¹⁰ The start date corresponds to actual start date with all legal documents in place.

¹¹ For further info see Chapter 1 "Introduction to the Programme Scene Setter / Objectives" with key technology themes / demonstration areas. Detailed information available in the CS2 Development Plan accessible via the Clean Sky JU Website and EC Participant Portal.

1. Background

Within the “Common Technology Bricks for Future Engines” activity in LPA Platform 1, a range of technologies are developed that are key elements of more than one future engine configuration. These technologies are matured at sub-system level, and since they mandatory for a number of exploitation routes, they are also referred to as enabling as well as transversal technologies. Many studies are ongoing to drive the development of new engine architectures (e.g. geared solutions) for EIS in 2030+, able to increase the thermodynamic cycle efficiency. In this context, one of the key enabler to support these solutions is the power gearbox that will be required to be very efficient, light, compact and reliable. Power gearboxes, typically included in this new geared engine solutions, are being studied extensively, but their behaviour in off-design conditions (e.g. temporary loss of lubrication, windmilling) is still to be understood and auxiliary and/or secondary lubrication systems are needed for safety, reliability and operability.



Pictorial representation of solid material contact with full lubrication (a) and boundary/starved lubrication (b). Condition (b) may lead to material scoring/damage.

Lubrication system optimization and power gearbox characterization in off-design conditions, main topics of this Call for Proposal, have been considered as fundamental technologies to be improved to match these goals. Loss of lubrication (e.g. negative-g, windmilling) is responsible for gears scoring and possibly bearings scoring (if roller bearings are used). To survive off-design conditions, auxiliary or emergency systems are used, so that the lubricant is provided by a second system that intervenes whenever the first one is not working. Such systems entail more complexity and weight, thus resulting in a downgrade of performance and more fuel burnt.

New technologies, coming either from lubrication system design, gearbox housing and/or sump design, gears and bearings design and new materials, may be enablers to reduce fluid systems complexity and weight.

This proposal is aimed to study these enabling technologies, including characterization, design and demonstration.

2. Scope of work

The applicant is asked to study the friction behaviour of contacting material under lubricated and non-lubricated conditions, with loads, speeds and characteristics related to aeronautical gears and bearings. Friction characterization shall be performed via experimental testing on TRL2 rig, related results shall be accounted for to design gears optimized to run in off-design conditions (e.g. loss of lubrication) and the design shall be validated on a TRL3 rig.

The project is composed of four main tasks:

T1 – State of the Art

The applicant shall review the state of the art regarding friction behaviour of gears and bearings, including empirical OD models, semi-empirical 1D models, numerical 3D models, experimental campaigns up to TRL4 rigs. The applicant shall derive lessons learnt and best practices for designing/adapting/modifying a TRL2 rig to perform the activity of task 2, as well as the most suitable numerical tool to be used as predictor and post-processor for the experimental results of task 2 and task 4 and for accomplishing the design activity of task 3.

T2 - Friction Characterization through experimental campaign TRL2 rig

The applicant shall characterize the frictional behaviour of different materials experiencing load and speed conditions typical of aeronautical gears and bearings (indications will be provided by the Topic Manager). Contacts shall be investigated in lubricated conditions and in off-design conditions (temporary absence of lubrication, permanent absence of lubrication, dry) and effect of several parameters shall be identified, namely load, sliding speed, rolling speed, roughness, material type and others.

In order to accomplish this task, a dedicated rig shall be designed and procured. Furthermore, Test Articles (T/As) shall be designed and procured. The task is therefore composed of the following sub-tasks:

- TRL2 rig design (e.g. disk machine)
- T/As design
- TRL2 rig and T/As procurement
- Experimental Activities
- Post-processing

The TRL2 rig shall – at least – comply with the following high-level requirements:

- The rig shall simulate the contact between sliding materials
- The rig shall be capable of testing with different materials and geometry characteristics (radius of curvature)
- The rig shall be capable of measuring the frictional loss in an accurate way
- The rig shall be capable of providing normal contact load up to 1E6 N/m, or alternatively a contact pressure up to 2000 MPa
- The rig shall be capable of simulating rolling speeds up to 100 m/s and sliding speed up to 50 m/s (100 m/s nice to have)
- The rig shall be capable of providing lubrication with different lubricants, with a pressure range of 0 to 10 bars and with a temperature range of 40 °C to 180 °C
- The rig shall be capable of handling lubricant flow in transient phases, i.e. having valve and accessory provisions
- The rig shall be capable of telemetry
- The rig shall comply with European and local regulations, EHS regulations and any other regulation required for running experimental activities of rotating/moving parts

An example of such kind of TRL2 rig is a disk-machine rig.

After rig and T/A design, rig and T/A procurement, the applicant shall propose a test campaign to be agreed with the topic manager. The test campaign shall at least include sensitivities of the following parameters: T/A geometry, T/A material, contact load, rolling speed, sliding speed, lubricant flow, lubricant type, lubricant temperature, lubricant starvation up to dry conditions. Pre-test predictions shall be performed with the tool(s) selected in task 1 and results shall be post-processed the same way.

T3 - Gear Design Optimization for Off-Design Conditions

The applicant shall leverage from the friction characterization performed in task 2 to derive solution for aeronautical gear design optimization for coping with off-design conditions. Solutions can also be related to passive lubricant system provisions that enables the run-out of the off-design conditions. The applicant shall provide solutions/lines-of-sight addressing the following macro-topics:

- Geometry
- Material (including roughness)
- Operating Conditions
- Passive Lubrication

T4 - Design and Technology Validation of Proposed Solution through experimental power rig test campaign TRL3

The applicant shall validate the solutions envisaged in task 3 on a TRL3 power test rig, via an extensive experimental campaign. Gears provided with the design solutions identified in task 3 shall be designed and procured by the applicant, as well as lubricant system solutions for off-design conditions.

In order to accomplish the validation, a dedicated TRL3 power test rig shall be used, either designed and procured by the applicant or adapted by the applicant.

The TRL3 rig shall – at least – comply with the following high-level requirements:

- The rig shall run with spur gears or bi-helical gears (fixed center-distance is acceptable)
- The rig shall be capable of measuring the frictional loss in an accurate way
- The rig shall be capable of same operating range as TRL2 rig
- The rig shall be capable of telemetry
- The rig shall comply with European and local regulations, EHS regulations and any other regulation required for running experimental activities of rotating/moving parts

After rig and T/A design, rig and T/A procurement, the applicant shall propose a test campaign to be agreed with the topic manager. The test campaign shall at least include sensitivities of the following parameters: T/A geometry, T/A material, contact load, rolling speed, sliding speed, lubricant flow, lubricant temperature, lubricant starvation up to dry conditions. Pre-test predictions shall be performed with the tool(s) selected in task 1 and results shall be post-processed the same way.

The above-mentioned requirements will be fixed in more details during the partner agreement phase. This will also include the IP-process.

Tasks		
Ref. No.	Title – Description	Due Date
T1	State of The Art	T0 + 2
T2	Friction Characterization through experimental campaign TRL2 rig	T0 + 14
T3	Gear Design Optimization for Off-Design Conditions	T0 + 17
T4	Design and Technology Validation of Proposed Solution through experimental power rig test campaign TRL3	T0 + 30

Schedule for Topic Project (Level 2 Gantt):

ACTIVITIES	YEAR 1												YEAR 2												YEAR 3					
	M1	M2	M3	M4	M5	M6	M7	M8	M9	M10	M11	M12	M1	M2	M3	M4	M5	M6	M7	M8	M9	M10	M11	M12	M1	M2	M3	M4	M5	M6
TASK 1	State of the art																													
TASK 2	TRL2 Rig and T/A Design																													
TASK 3	Gear Design Optimization																													
TASK 4	T/A Design (gears)																													
	T/A Procurement																													
	TRL3 Rig Design&Procurement/Adaptation																													
	Testing Activity and Post-Processing																													

3. Major Deliverables/ Milestones and schedule (estimate)

*Type: R=Report, D=Data, HW=Hardware

Deliverables			
Ref. No.	Title - Description	Type*	Due Date
D1	State of The Art – State of the art reporting, including experimental and numerical activities performed in the past	R	T0 + 2
D2	Friction Characterization through experimental campaign TRL2 rig – Report with rig and T/A design description, experimental campaign, data and post-process	R, D	T0 + 14
D3	Gear Design Optimization for Off-Design Conditions – Report containing description of gear design optimization solutions and alternative lubrication solutions for off-design conditions	R	T0 + 17
D4.1	Design and Technology Design – Report containing details of gear proposed design	R	T0 + 20
D4.2	Validation of Proposed Solution through experimental power rig test campaign TRL3- Report containing description of TRL3 rig, testing activities, data and post-process	R, D	T0 + 30

Milestones (when appropriate)			
Ref. No.	Title - Description	Type*	Due Date
R1	Kick Off - Agreement on detailed spec & Overall plan	Meeting	T0 + 1
R2	TRL2 rig and T/A design review	R, Meeting	T0 + 4
R3	TRL2 Rig Test Design Review – Review of proposed test, risks, instrumentation	R, Meeting	T0 + 10
R4	T/A Design Review (for TRL3 rig)	R, Meeting	T0 + 20
R5	TRL3 Rig Test Design Review – Review of proposed test, risks, instrumentation	R, Meeting	T0 + 26
R6	Closure Meeting – Final Results, Outcomes	Meeting	T0 + 30

4. Special skills, Capabilities, Certification expected from the Applicant(s)

Essential:

- Extensive and proven experience in friction generation modelling
- Proven experience in gears design
- Proven experience in fluid-dynamics topics
- The applicant needs to demonstrate to be in the position to have access to the test facilities TRL2 required to meet the topic goals or to have design and procurement capabilities.



- Experience in rig design and supply chain management (for T/As procurement and relative measurements & inspections)
- Experience in aerospace R&T and R&D programs, program management
- Applicant needs to demonstrate to have access to TRL3 rig, or design and procurement capabilities.
- Proven experience of gear testing, including instrumentation, rig handling and dynamics capabilities

5. **Abbreviations**

CAD	Computer Aided Design
CFD	Computational Fluid Dynamics
EIS	Entry Into Service
JU	Joint Undertaking
IADP	Integrated Area Development Program
LPA	Large Passenger Aircraft
LPS	Low Pressure System
TA	Test Article
TRL	Technology Readiness Level

III. JTI-CS2-2020-CfP11-LPA-01-90: Automated thermography for inspection of welded safety critical engine components

Type of action (RIA/IA/CSA):		IA	
Programme Area:		LPA	
(CS2 JTP 2015) WP Ref.:		WP 1.1.3	
Indicative Funding Topic Value (in k€):		700	
Topic Leader:	GKN	Type of Agreement:	Implementation Agreement
Duration of the action (in Months):	24	Indicative Start Date (at the earliest)¹²:	> Q4 2020

Topic Identification Code	Title
JTI-CS2-2020-CfP11-LPA-01-90	Automated thermography for inspection of welded safety critical engine components
Short description	
Thermography has a potential to increase probability of detection of defects as well as enhance accessibility for fast, automated non-destructive evaluation of aero engine components. This project aims at developing full-scale thermography inspection of near surface defects very small defects on welded and machined engine frames.	

Links to the Clean Sky 2 Programme High-level Objectives ¹³				
This topic is located in the demonstration area:		Advanced manufacturing		
The outcome of the project will mainly contribute to the following conceptual aircraft/air transport type as presented in the scene setter:		Advanced Long-range Ultra-advanced Long-range Advanced Short/Medium-range Ultra-advanced Short/Medium-range		
With expected impacts related to the Programme high-level objectives:				
Reducing CO ₂ emissions	Reducing NO _x emissions	Reducing Noise emissions	Improving EU Competitiveness	Improving Mobility
<input checked="" type="checkbox"/>	<input type="checkbox"/>	<input type="checkbox"/>	<input checked="" type="checkbox"/>	<input type="checkbox"/>

¹² The start date corresponds to actual start date with all legal documents in place.

¹³ For further info see Chapter 1 "Introduction to the Programme Scene Setter / Objectives" with key technology themes / demonstration areas. Detailed information available in the CS2 Development Plan accessible via the Clean Sky JU Website and EC Participant Portal.

1. Background

The Open Rotor Engine architecture with its inherent high efficiency due to the high propulsive efficiency may be a game changing concept for environmentally friendly aviation. In the previous Clean Sky project, an Open Rotor engine was developed and tested in full scale, see Fig 1. The test successfully proved reduced fuel consumption and low noise emission.

Open rotor engine designs rely on large diameter propeller stages being mounted into the rotating core of the engine without having an outer containment case to catch blades or any debris in the event of failure, therefore the rotating hub is a safety critical module. For the specific design of the open rotor engine in Fig 2, the rotating frame modules have internal flow passages to allow for the hot core engine gas stream to exit which makes the geometry complex. This geometrical complexity has resulted in a design consisting of several subcomponents integrated into a weld assembly. Welding is a critical process which needs to be mastered together with subsequent post processing and non-destructive testing (NDT). This research topic addresses the development and adoption of automated active thermography to improve the probability of detection of defects generated or appearing in the welding process.

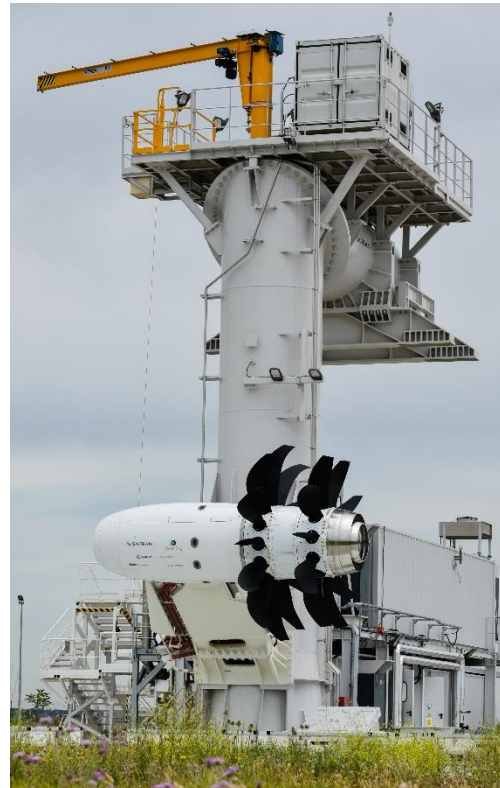

Figure 1. Engine test in Clean Sky

The current state of art approach to ensure defect free structures is by inspection with radiography for volumetric defects and fluorescent penetrant inspection (FPI) for surface defects. The drawback with FPI is that it relies on manual inspection for finding and classifying defects. By the introduction of thermography with and adding secondary sensor information it is anticipated that the surface inspection will become quicker and generate a higher probability of detection of defects. Therefore this piece of research is considered as a critical enabling technology brick for future open rotor architectures



Figure 2. A rotating frame

This CfP topic aims at demonstrating TRL5 for surface defect detection, characterization and localisation on raw and ground but-welds - both for in-process control and for final inspection and quality acceptance. The material is Alloy 718 and the prime welding method is laser welding with TIG welding as secondary option. It is foreseen that the system will need to operate with secondary sensor system(s) for added redundancy and/or to distinguish between false positive indications – such as oxides, variations in weld surface geometry or reflections – and true indications. This is to overcome the difficulties of surfaces with varying optical properties – reflecting or not - and the very small defects that need to be found - for instance sub-mm closed cracks.

For final inspection, the NDT system is intended to assist the operator in making the final accept/not accept decision based on defect type classification and sizing. The project will conclude by a

demonstration of the process' applicability on a relevant demonstrator component to prove accessibility and time for inspection. It is foreseen that the technology demonstrator comprises an industrial scale manipulator with developed tools to achieve robust data acquisition during the inspection process. The sensory system including the developed active thermography system will need to follow the part surface and demonstrate robust capability during full inspection sequence.

On the way towards final demonstration, justification of probability of detection of defects must be generated with smaller samples with pre-fabricated and real defects with known properties such as type, location and size. The method capability estimation will follow the required methodology for aerospace inspection of components designed with respect to damage tolerance. The assessment of the method may include artificially introduced defects but must also provide a quantitative estimation on performance on realistic defects including surface breaking weld porosity and narrow linear defects such as solidification and liquation cracking that can occur in welding of nickel based super alloys.

The work is proposed to go through the following steps:

1. Definition of process and inspection requirements and method capability assessment together with Topic Manager
2. Identification of NDT system – Thermography, Imaging technology, Automation, Secondary sensors, Data analysis and Defect classification software. This activity should evaluate the whole technology application scope of welding methods, raw or ground weld seam, in-process or final control. The assessment should be quantitative and assess geometrical accessibility, time of execution and probability of detection – preferably by simulation and proof of concept validations.
3. Development and verification of sub-systems on realistic industrial level. Key process variables are clearly demonstrated at this stage and critical requirements determined. The results in this step will provide a process parameter space within which the process is intended to operate.
4. Probability of Detection quantification on test samples. The capability assessment to estimate the probability of detection is planned together with Topic Manager. The assessment will validate the capability within the valid process parameter space and sensitivity to critical functionality will be demonstrated. It is anticipated that simple test objects will be used for the purpose. As such it is not anticipated that method capability will be demonstrated on real parts including defect distribution.
5. Final demonstration on a relevant component – the component will be supplied by the topic manager.



Figure 3. The final demonstrator will probably consist of two super alloy sectors (as above) welded together. Size is typically 25 cm in all dimensions.

The research aspects of the proposed topic are threefold and they are all related to aspects of the development of thermography for surface inspection of welds:

- The active thermography is applied as a nondestructive evaluation method on a welded surface

which contain natural geometrical variations, oxides, discolourations. The variation of surface emissivity in combination with high thermal conductivity, will pose a challenge to resolve large temporal and spatial thermal gradients to discriminate minute defects. The anticipated adoption of a secondary sensor system that is deployed simultaneously to improve probability of detection of true defects is seen as being beyond current state of art.

- The capability of active thermography must be demonstrated within the framework of probability of detection with relevant defect characteristics such as short and narrow cracks.
- The thermography inspection technology needs to be demonstrated on relevant component and key process variables verified within the parameter space within which probability of detection is estimated.

To further emphasise the need for advanced research it is proposed to include modelling of the physics involved to strengthen the understanding of the phenomena and to validate these models by for instance measurements quantifying detection differences between artificial and real defects. A theoretical and model based approach is also needed to identify how the critical discrimination between acceptable surface conditions and defects should be assessed as well as understanding the limitations for near surface defects.

The project output will be a realistic component demonstration with quantified capability estimation and understanding of key process variables and requirements.

2. Scope of work

Tasks		
Ref. No.	Title – Description	Due Date
1	<u>Process and inspection requirements</u> <ul style="list-style-type: none"> - Definition of process requirements and validation plan documented. This should be done in discussion with the Topic Manager. - System and testbed for lab scale tests identified - Plan for manufacture and definition of test pieces for concept evaluations and probability of detection assessment Output 1 – List of requirements and Validation plan Output 2 – POD samples defined	M6
2	<u>Identification of NDT system</u> <ul style="list-style-type: none"> - NDT system is designed, built and commissioned and critical functionalities tested. - Strategy to handle false/positive indications is tested and compared to theory and possibly simulations. Output 1 - List of key process variables and documented assessment of their influence on inspection process metrics. Output 2 – Description of defect classification strategy and system intended to reduce false indications.	M10

Tasks		
Ref. No.	Title – Description	Due Date
3	<p><u>Development and verification of sub-systems</u></p> <ul style="list-style-type: none"> - Sensory system development and integration on robotic manipulator. - Development of monitoring features and verification principles for key process variables - Verification of the sub-system may partly be done with, or supported by, simulation methods. <p>Output 1 – Sub-system verification on samples with needed monitoring system to ensure that the process is operated within the design space of key process variables to ensure that the process requirements are fulfilled.</p>	M14
4	<p><u>Probability of Detection quantification on test samples</u></p> <ul style="list-style-type: none"> - The probability of detection assessment is executed. - Influence on defect types and reliability within process parameter space validated and documented. <p>The test specimens should be acquired by the CfP consortium. The majority of the specimens can be made in welded or forged sheet Alloy 718 but cast and AM material forms should also be included in the experiments as well as at least one alternative super alloy. It is anticipated that in total 40 representative, well known, realistic defects will be the minimum to gain statistical confidence for POD within the valid process window.</p> <p>Output 1 – POD curve with estimation of a90/95 flaw size and receiving operator characteristics curve</p> <p>Output 2 – Estimation of capability difference between real and artificially introduced defects</p>	M18
5	<p><u>Final demonstration</u></p> <ul style="list-style-type: none"> - Inspection system prepared and executed for component process validation. Of specific interest for the final demonstrator is to quantify accessibility limitations and process execution times – including time for classification of defects. <p>The demonstrator hardware will be supplied by the Topic manager.</p> <p>Output 1 – Inspection process demonstration and quantification of accessibility limitations and process execution times.</p> <p>Output 2 – Results, conclusions and lessons learned summarized</p>	M22

3. Major Deliverables/ Milestones and schedule (estimate)

*Type: R=Report, D=Data, HW=Hardware

Deliverables			
Ref. No.	Title - Description	Type*	Due Date
D1	Detailed project plan	R	M2
D2	System requirements and test plan documented	R	M4
D3	Sensory system specification w. KPVs	R	M8
D4	Technical report on system to reduce false indications	R	M10
D5	Experimental design for POD assessment	R	M12
D6	Sub-system verification report	D, R	M13
D7	POD curves reported	D, R	M20
D8	Lessons learned from component demonstrator	R	M24

Milestones (when appropriate)			
Ref. No.	Title - Description	Type*	Due Date
M1	Review of validation plan	R	M4
M2	Review and approval of NDT system proposal	R, HW	M6
M3	Review of plan and HW for POD assessment	R	M10
M4	POD samples ready	HW, D	M14
M5	POD Curves calculated from inspection data	D, R	M18
M6	Thermography system experiment conducted on the component demonstrator	HW, R	M22

4. Special skills, Capabilities, Certification expected from the Applicant(s)

Essential:

- The consortium should previously have demonstrated active thermography applied for nondestructive evaluation of metallic surfaces with sub-mm defects.
- Extensive experience and laboratory resources including sensory and heat excitation equipment for active thermography including also industrial robots for sensory system manipulation.
- Experience and tools for modelling and simulation of thermal diffusion and optical interaction on metallic surfaces
- NDT knowledge of Aerospace requirements for critical part inspections including inspection method capability assessments using probability of detection methodology.
- Experience from industrial thermography used for non-destructive evaluation.

5. Abbreviations

- FPI Fluorescent Penetrant Inspection
- NDT Non Destructive Testing
- KPV Key Process Variable
- POD Probability of Detection – A methodology to quantitatively estimate the capability of an NDE method under specific circumstances including equipment and procedure.
- TRL 5 Technology Readiness Level 5 – Basic prototype validated in relevant environment:
- Realistic versions of the proposed technology are tested in real-world or near real-world conditions, which includes initial integration at some level with other operational systems.
 - Testing is conducted to understand the significance of any variation, on the technologies ability to meet the product requirements.

IV. JTI-CS2-2020-CfP11-LPA-01-91: Development and validation of a method to predict non-linear aerodynamic characteristics of lifting surfaces with controls

Type of action (RIA/IA/CSA):		RIA	
Programme Area:		LPA	
(CS2 JTP 2015) WP Ref.:		WP 1.2	
Indicative Funding Topic Value (in k€):		750	
Topic Leader:	Airbus	Type of Agreement:	Implementation Agreement
Duration of the action (in Months):	24	Indicative Start Date (at the earliest)¹⁴:	> Q4 2020

Topic Identification Code	Title
JTI-CS2-2020-CfP11-LPA-01-91	Development and validation of a method to predict non-linear aerodynamic characteristics of lifting surfaces with controls
Short description	
<p>The purpose of this research proposal is to develop numerical methods for the prediction of the non-linear aerodynamic characteristics of lifting surfaces, of the type used in the tails of commercial aircraft. The maximum lift coefficient of the lifting surface, including deflected controls, is of interest for the design of efficient empennages and a rapid means to estimate this parameter is required. The methods to be developed will be calibrated and validated using a systematic series of wind tunnel tests of several models covering a wide range of planform parameters, with and without simulated ice shapes.</p>	

Links to the Clean Sky 2 Programme High-level Objectives ¹⁵				
This topic is located in the demonstration area:		Enabling Technologies		
The outcome of the project will mainly contribute to the following conceptual aircraft/air transport type as presented in the scene setter:		Advanced Long-range Ultra-advanced Long-range Advanced Short/Medium-range Ultra-advanced Short/Medium-range		
With expected impacts related to the Programme high-level objectives:				
Reducing CO ₂ emissions	Reducing NO _x emissions	Reducing Noise emissions	Improving EU Competitiveness	Improving Mobility
<input checked="" type="checkbox"/>	<input type="checkbox"/>	<input type="checkbox"/>	<input type="checkbox"/>	<input type="checkbox"/>

¹⁴ The start date corresponds to actual start date with all legal documents in place.

¹⁵ For further info see Chapter 1 "Introduction to the Programme Scene Setter / Objectives" with key technology themes / demonstration areas. Detailed information available in the CS2 Development Plan accessible via the Clean Sky JU Website and EC Participant Portal.

1. Background

Work Package 1.2 is devoted to the development of concepts, enabling technologies and capabilities for the design and manufacture of the optimum rear fuselage and empennage for the next generation of commercial aircraft.

The Advanced Rear End (ARE) concept, developed in WP1.2, aims at the integration of conceptual and aerodynamic design, structural and systems architectures, materials technologies and industrial processes to help achieve new standards in economic, environmental and manufacturing efficiency and flexibility.

A demonstrator of an Advanced Rear End will be developed and tested. This research topic will contribute to defining the optimal configurations that will allow to:

- Deliver the following performance improvements at component level with respect to the 2014 short range reference aircraft: 20% Weight reduction, 20% recurring costs reduction, 50% Lead time reduction
- Reduce the fuel burn at aircraft level by 1.5% stemming from the previous goals
- Deliver Digital Mock-Ups and Technical Definition Dossiers of an integrated Advanced Rear End

2. Scope of work

In order to fulfil the objectives laid out in the previous section, the following lines of work will be carried out in this proposal:

- Low speed wind tunnel testing of a systematic series of lifting surfaces covering a wide range of planform parameters, leading edge shapes and control deflections, with and without simulated ice shapes. The purpose of the series of tests is to generate a database of aerodynamic characteristics that will be used for the development, calibration and validation of numerical methods. The effect of a smooth adaptation of the control surface based on a morphing solution will also be tested.
- Development of a low order method for the prediction of the maximum lift coefficient and control hinge moment of any lifting surface within the range of parameters covered by the systematic series of geometries tested in the wind tunnel.
- Development of calibration methods for high order CFD analysis in order to extend the prediction of the maximum lift coefficient and hinge moment of tail surfaces to an arbitrary Reynolds number.

It is not sought to create a surrogate model just based on an interpolation approach. The goal of this research project is to develop a low order numerical method based on physical phenomena as far as possible and which may include small correction factors to match the results of the wind tunnel tests of the systematic series.

In the context of this project, the “order” of a method refers to its sensitivity to the detail of the analysis model. A “low order, physics based” method uses relatively simple mathematical models of the flow behaviour (for example, vortex lattice or panel methods) and is not too sensitive to the details of the geometry. The sought method must contemplate, however, the aerofoil shape and the Reynolds number of operation, possibly through surrogate models based on 2D physics based analysis.

On the other hand, “high order” methods refer to traditional CFD tools based on the Navier-Stokes or Lattice Boltzmann equations. These approaches require a geometric definition with a high level of detail and accuracy which is normally not available during the initial design phases, when the tail surfaces are being sized.

The performance improvement objectives sought in the Clean Sky 2 project call for a departure from the conventional empennage configurations and technologies that constitute the state of the art in aircraft design. An “Advanced Rear-End” component for the next generation of ultra-efficient aircraft might consist of a very compact rear fuselage and tail surfaces with planforms significantly different to those used in current practice in terms of their aspect or taper ratios and sweep angle.

The existing methods used in the initial sizing of the empennage rely on semiempirical approaches based on historical data. This prevents an effective exploration of the full design space currently enabled by the advent of novel structural, control and aerodynamic technologies, or of configurations oriented to the reduction of production costs.

The following sections detail the lines of work proposed in order to accomplish the overall goals of this project.

2.1 Efficient Generation of a systematic series of geometries to span a wide design space of tail surfaces

A systematic series is a sample of a design space spanned by a reduced number of parameters which covers the behaviour of all possible configurations within that space. In this project, the sample consists of a number of well-defined trapezoidal planforms, where variations of the following key parameters are to be considered:

- Aspect ratio (defined as $\text{span} \times \text{span} / \text{reference area}$)
- Taper ratio (defined as the ratio of the tip chord to the root chord of the supporting trapezoid of the planform)
- Sweep angle (defined as the angle between a reference line at the 25% of the planform chord line and a normal to the plane of symmetry of the aircraft)

Additional important parameters of a lifting surface are its dihedral angle and its size, normally given by its reference area. The geometries under study will have no twist. In this project, the area of the surface shall be made as large as possible –within the limits of the wind tunnel- in order to maximise the Reynolds number.

- RANGE OF VARIATION OF PLANFORM PARAMETERS
- Sweep @25%chord: -40 deg to 40 deg
- Aspect Ratio: 3.5 to 7
- Taper Ratio: 0.2 to 1
- Dihedral: 0 deg to 45 deg

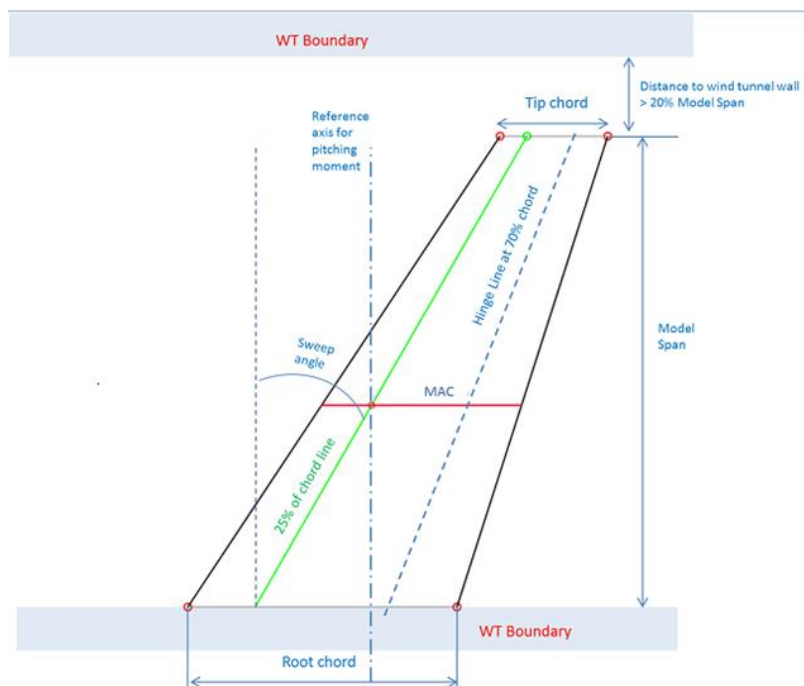

Figure 1 Planform definition of a trapezoidal lifting surface and wind tunnel constraints

Finally, the complete definition of the aerodynamic surface requires the specification of at least one aerofoil section. In this project, 3 aerofoil sections with round leading edge and one with a sharp leading edge will be studied. The sections will be provided by the Topic Manager and will be defined so that

modular manufacturing is possible by replacing a leading edge module extending up to the 30% of the local chord.

The effective selection of the elements of the systematic series to cover the design space of trapezoidal tail surfaces is a critical decision as it will affect the cost of the wind tunnel testing. It is the responsibility of the applicant to define a strategy to create the systematic series that minimises cost and time while guaranteeing that the design space is effectively covered in terms of aerodynamic behaviour. The boundaries of the design space are defined in figure 1;

It must be noted at all times that in order to obtain a valid reference for the maximum lift coefficient, the aerofoil sections perpendicular to the nominal plane of chords must be the same in all the models under test.

2.2 Smart design and manufacturing of modular wind tunnel models

In order to reduce the cost of production of the wind tunnel models as well as the generation of consistent low and high order aerodynamic analysis models, a “smart” approach is sought, relying on a parametric CAD geometric model capable to automatically export analysis models, including controls deflected, and to capture the key characteristics of each planform to enable the generation of models suitable for manufacturing. Of particular interest is the automatic generation of CFD meshes in order to expedite the numerical calculations.

2.3 Low speed wind tunnel testing

The wind tunnel models shall be tested at low speeds (see requirements in section 5) in order to obtain the following responses:

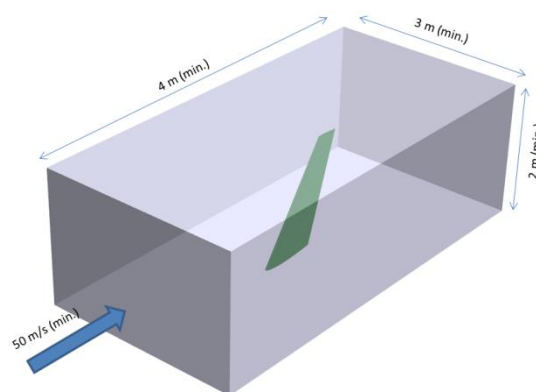

Figure 2 Minimum Wind Tunnel dimensions and speed

2.3.1 For each of the 4 aerofoils, with and without ice shapes:

A. With zero dihedral angle

- Boundary layer transition line at zero angle of attack and no control deflection. The location of the transition line is required in order to validate the transition criteria used in the aerodynamic calculations of the 2D section used to feed the numerical method. Infra-red thermography methods are recommended in order not to spoil the boundary layer behaviour.
- For a range of static deflection angles of the control surface between -35 deg and 35 deg, the relation of the following forces and moments with respect to angle of attack shall be measured (referred hereafter as the full set of aerodynamic characteristics):
 - o Surface lift and drag (and derived coefficients)
 - o Surface “pitching” moment around its aerodynamic centre
 - o Hinge moment of the control surface

- Determination of the hinge moment coefficient, lift versus angle of control deflection and maximum lift coefficient for a range of frequencies of oscillatory control deflection at zero angle of attack reaching no less than a frequency of 2 Hz.
 - B. For a range of dihedral angles between 0 deg and 45 deg, with and without ice shapes:
 - For each planform tested; relation of lift and pitching moment versus angle of rotation about an axis normal to the nominal plane of symmetry of the aircraft with no deflection of the control surface.
- The determination of the ice shapes will build on the work performed within ARE_Cfp10, where these shapes will be obtained numerically. The shapes can be built using 3D printing technologies and installed at the leading edge of the surfaces. The liaison between the two projects, if necessary, will be provided by the topic manager.

2.3.2 For each of the 4 aerofoils on a reference planform with a morphing trailing edge adaptation:

With zero dihedral angle and the segment of trailing edge with morphing technology (to be provided by the Topic Manager), obtain the full set of aerodynamic characteristics of the lifting surface with and without ice shape on the leading edge. The reference planform shall have an aspect ratio of 5 (referred to a symmetric surface), taper ratio of 0.4 and sweep angle (@25% of the chord) of 30 deg.

2.3.3 Model tolerances

All wind tunnel models shall comply with the following geometric tolerances:

- Shape deviation with respect to the nominal definition : +/- 0.2 mm
- Surface roughness Ra: <0.2µm up to 30% of the chord, then <1µm
- Step at 30% of the chord (modular joint) : 0.1 mm max.
- Model deformation from nominal shape at 50 m/s and 10 deg of angle of attack: less than 25mm at the tip

2.4 Development of a low order method for the prediction of the non-linear aerodynamic characteristics of lifting surfaces

The main objective of this project is to develop a numerical method to predict the relevant aerodynamic characteristics for any trapezoidal planform of a tail surface, including the deflection of the controls, in order to allow the efficient and effective exploration of the design space during the preliminary sizing of aircraft.

Given the intended application, the prediction method needs to execute in a very short time (in the order of a few seconds on a desktop computer) so that optimization methods can be applied. The method needs to be sensitive to trapezoidal planform parameters, dihedral and control deflection angles, aerofoil shape, Reynolds number and the presence of a nominal ice shape on the leading edge. The method shall also be sensitive to the shape of the fuselage –a simplified model is acceptable- and the wing downwash –which is expected to be calculated including wake relaxation.

The requirement to capture the aerofoil effect on the maximum lift characteristics excludes statistical or response surface approaches given the large dimensionality of the design space of aerofoils. Therefore, the method, although of “low order”, needs to be based on physical responses. It is suggested that the problem is decomposed into a purely 2D analysis to predict aerofoil characteristics and a classical 3D low order method corrected to take into account viscous, sweep and dihedral effects.

In the most general case of application, the aerofoil characteristics may be available from either wind tunnel testing or obtained using high order CFD calculations. Thus, the decoupling between the 2D and 3D problems will allow the use of previously existing high quality aerofoil data, or to perform ad-hoc parametric studies on the aerofoil characteristics.

The calculation of non-linear characteristics (in particular, onset of break-away from linear behaviour, maximum lift coefficient and corresponding angle of attack and, ideally, an indication of the post-stall behaviour) shall also be performed with controls deflected.

2.5 Development of a methodology to extend the numerical prediction of non-linear aerodynamic characteristics to an arbitrary Reynolds number

The design of lifting surfaces for large aircraft requires the use of aerodynamic data at Reynolds numbers corresponding to the real surface size and aircraft flight speed.

It is generally impractical to obtain these characteristics using only wind tunnel testing and, therefore, there is a need for a reliable methodology to extrapolate the low speed wind tunnel test results to flight conditions.

The applicant is expected to perform the calibration of the high order CFD analysis of the geometries tested in the wind tunnel in order to match the experimental results at low Reynolds number. Then, the high order method shall be run at a Reynolds number corresponding to flight conditions and the results obtained shall, in turn, be used to extend the low order method to an arbitrary Reynolds number (always at Mach numbers below 0.3, as a reference).

INNOVATION VALUE AND GENERATION OF KNOWLEDGE

This project explores three main innovation dimensions:

- Development of novel numerical methods for the prediction of non-linear aerodynamic characteristics of lifting surfaces and control hinge moments.

Theoretical aerodynamic analysis around the stall is a difficult problem, particularly if it is required that the methods used are based on simplified geometries and that the analysis executes in times compatible with the needs of the preliminary design phases. There are known methods applicable to straight wings (see NACA report No 865), but these fail when the lifting surface has any significant sweep angle.

The topic of prediction of stall characteristics of swept wings is being researched actively at present, with less than satisfactory results (see "A new non-linear vortex lattice method: applications to wing aerodynamic optimizations", Gabor, Botez and Koreanschi, Chinese Journal of Aeronautics, Aug2016, "Sweep effects on non-linear Lifting Line Theory near Stall", Gallay, Ghasemi, Laurendeau, AIAA SciTech 2014, "Improved Stall Prediction for Swept Wings Using Low-Order Aerodynamics", Hosangadi, Paul, Gopalarathnam, AIAA 2015. "Nonlinear vortex lattice method for stall prediction", Hasier Goitia Hernández, Raúl Llamas Sandín, EASN Conference, Athens 2019).

The methods to be developed in this project will enable to perform multidisciplinary planform optimization of lifting surfaces with maximum lift constraints, which is a problem currently out of the reach of industry.

- Generation of a database of aerodynamic characteristics of lifting surfaces covering a wide range of design parameters.

A robust aerodynamic database is essential to validate and calibrate aerodynamic methods, particularly in the non-linear regime.

There is a notorious shortage of information on experimental results on the aerodynamic characteristics of planforms of unusual proportions. One of the few references is NACA TN2445, written in 1951 but even this lacks much of the information which will be generated in this project.

Using the smart approach for the simultaneous geometry and mesh generation, to be developed in this project, it will be very simple to compare experimental and theoretical results on exactly the same geometry, removing uncertainties and making the calibration process very robust.

- Development of a methodology for the extrapolation of non-linear aerodynamic characteristics of lifting surfaces to an arbitrary Reynolds number.

The aerodynamic prediction methods, although validated with tests at low Reynolds numbers, need to be accurate at flight Reynolds numbers. In this project, a methodology will be developed, using calibrated high fidelity CFD, to extend the applicability of the wind tunnel results to flight conditions,

covering also an existing technology gap.

3. **Major Deliverables/ Milestones and schedule (estimate)**

*Type: R=Report, D=Data, HW=Hardware, RM = Review meeting, SW=Software

The main deliverables of this project are:

- Generation of a systematic series of geometries covering a wide design space of tail surfaces
- Manufacture and dynamic characterization of low cost modular wind tunnel models based on the above geometries (determination of the moment of inertia, friction and damping coefficients of the control surface)
- Aerodynamic testing of the modular models and data processing
- Development of a theoretical low order, physics based model for the prediction of non-linear characteristics of the tail surfaces spanned by the design space covered by the systematic series, including hinge moments
- Development of a calibration method to adjust high order CFD models to obtain non-linear aerodynamic characteristics of tail surfaces matching the WTT results of the systematic series and a method for Reynolds extrapolation
- Adjustment of the low order physics based model to match the results of the wind tunnel tests and development of an extension methodology for an arbitrary Reynolds number so that the proposed theoretical model can be used for the preliminary sizing of tail surfaces
- Overall conclusions and recommendations

Deliverables			
Ref. No.	Title - Description	Type*	Due Date
ARE_C11_01	Partner contribution detailed description (content, deliverables, planning)	Report	T0 + 3
ARE_C11_02	Design of Wind Tunnel Model completed	Report and specimens	T0 + 6
ARE_C11_03	Wind Tunnel Testing report	Report	T0 + 12
ARE_C11_04	Theoretical report on the low order numerical method	Report	T0 + 12
ARE_C11_05	Intermediate reports on numerical methods; calibration and validation	Report	T0 + 18
ARE_C11_06	Final report	Report	T0 + 24

4. **Special skills, Capabilities, Certification expected from the Applicant(s)**

Essential:

- Advanced geometric modelling
- CFD analysis
- Low speed Wind Tunnel Testing
 - Wind Tunnel Model design and build. In-house model manufacturing and modification capability
 - Excellent mechanical design capability applied to aeronautical projects. Knowledge of design standards, materials and tolerancing.
- Demonstrated mechanical design capability to design and manufacture mechanisms and sensors for wind tunnel or mechanical testing.
- Use of the following equipment for aerodynamic analysis and testing:
 - High Performance Computing (HPC) and state of the art CFD solvers, preferably open

source.

- Testing facilities for the dynamic characterization of the control surfaces (preferably in vacuum), e.g., damping and moment of inertia
- Shape and roughness verification methods to guarantee that the models are manufactured within the stated specifications.
- Low speed wind tunnel with the following characteristics:
 - test section dimensions : 2m (minimum) in the span direction by 3m (minimum) in the complementary direction, in order to reduce wind tunnel blockage when the lifting surface is at very large angles of attack (e.g. around 40 deg.).
 - minimum test speed 50 m/s,
 - Wind Tunnel model used by applicant shall have a turbulence level **<0.25%** and uniformity **> 99%**, to be clearly demonstrated in the proposal.
 - Measurement means, preferably optical, to verify that the model deformation under aerodynamic load is within the stated tolerances in 2.3.3
 - force balances to measure lift, drag and yawing and hinge moment (at least), even in dynamic (oscillatory) conditions of the control surface
 - surface flow visualisation
 - infra-red thermographic cameras with enough sensitivity to detect boundary layer transition in air (or equivalent, non-intrusive, means)

Advantageous:

- Particle Image Velocimetry equipment
- Pressure Sensitive Paint

5. Abbreviations

CFD	Computational Fluid Dynamics
CDR	Critical Design Review
HPC	High Performance Computing
LE, TE	Leading Edge, Trailing Edge
VTP	Vertical Tail Plane
WTT	Wind Tunnel Testing
ARE_CfP10	JTI-CS2-2019-CfP10-LPA-01-80 “Rear fuselage and empennage shape optimization including anti-icing technologies”
deg.	degrees (sexagesimal)

V. JTI-CS2-2020-CfP11-LPA-01-92: Optimization of APU Exhaust Muffler Thermal Barrier and Air Intakes construction Technologies

Type of action (RIA/IA/CSA):		IA	
Programme Area:		LPA	
(CS2 JTP 2015) WP Ref.:		WP 1.2	
Indicative Funding Topic Value (in k€):		900	
Topic Leader:	Airbus Defence and Space	Type of Agreement:	Implementation Agreement
Duration of the action (in Months):	24	Indicative Start Date (at the earliest)¹⁶:	> Q4 2020

Topic Identification Code	Title
JTI-CS2-2020-CfP11-LPA-01-92	Optimization of APU Exhaust Muffler Thermal Barrier and Air Intakes construction Technologies
Short description	
<p>The purpose of this research topic is to develop :</p> <ul style="list-style-type: none"> - A new basic thermal barrier concept to be used in Exhaust Muffler that can be used in rear end fuselage or in other parts of the Aircraft where a power unit might be installed. - A new basic materials construction concept to be used in Air Intakes that can be used in rear end fuselage or in other parts of the aircraft. <p>Air Intakes and Exhaust Mufflers are parts of the system installation required for air breathing engines (such as an Auxiliary Power Unit) or other Aircraft systems. These parts provide a flow path for the external air needed, as well as the exhaust gas path. They provide other functions such as fire barrier (meet Fire Proof requirements according AC 20-135), noise attenuation and thermal insulation.</p>	

Links to the Clean Sky 2 Programme High-level Objectives ¹⁷				
This topic is located in the demonstration area:		Cabin & Fuselage		
The outcome of the project will mainly contribute to the following conceptual aircraft/air transport type as presented in the scene setter:		Advanced Long-range Ultra-advanced Long-range Advanced Short/Medium-range Ultra-advanced Short/Medium-range		
With expected impacts related to the Programme high-level objectives:				
Reducing CO₂ emissions	Reducing NO_x emissions	Reducing Noise emissions	Improving EU Competitiveness	Improving Mobility
<input checked="" type="checkbox"/>	<input type="checkbox"/>	<input checked="" type="checkbox"/>	<input type="checkbox"/>	<input type="checkbox"/>

¹⁶ The start date corresponds to actual start date with all legal documents in place.

¹⁷ For further info see Chapter 1 "Introduction to the Programme Scene Setter / Objectives" with key technology themes / demonstration areas. Detailed information available in the CS2 Development Plan accessible via the Clean Sky JU Website and EC Participant Portal.

1. Background

Work Package 1.2 is devoted to the development of concepts, enabling technologies and capabilities for the design and manufacture of the optimum rear fuselage and empennage for the next generation of commercial aircraft.

The Advanced Rear End (ARE) concept, developed in WP1.2, aims at the integration of conceptual and aerodynamic design, structural and systems architectures, materials technologies and industrial processes to help achieve new standards in economic, environmental and manufacturing efficiency and flexibility.

A demonstrator of an Advanced Rear End will be developed and tested. This research topic will contribute to defining the optimal configurations that will allow to:

- Deliver the following performance improvements at component level with respect to the 2014 short range reference aircraft: 20% Weight reduction, 20% recurring costs reduction, 50% Lead time reduction
- Reduce the fuel burn at aircraft level by 1.5% stemming from the previous goals.
- Deliver Digital Mock-Ups and Technical Definition Dossiers of an integrated Advanced Rear End.

Within this framework, WP1.2.4 intends to develop Systems Integration innovative solutions, as the systems installed in the rear end require a level of optimization, where new integration and installation by means of new materials are crucial. Development of bricks that enable new installation solutions will not only improve systems integration, but improve overall structural efficiency and environmental challenges.

The purpose of this topic is to identify, investigate and quantify new materials that can be used in the air intake and the exhaust muffler of an installed engine. Current concept of fire barriers, acoustic treatments and thermal insulation are based on long term existing solutions (proven thermal barriers, acoustic liners and thermal blankets). New materials as well as new build up concepts can provide innovative solutions for these specific applications.

2. Scope of work

The performance improvement objectives sought in the Clean Sky 2 project call for a departure of the conventional empennage configurations and technologies that constitute the state of the art in aircraft design.

An “Advanced Rear-End” component for the next generation of ultra-efficient aircraft will incorporate systems installation in the rear fuselage (e.g. Power Unit, air compressors for the air systems). Configurations that include propulsion in the rear end are not part of the analysed configurations, but this solution would be an enabler for such architecture.

The state of the art is based on proven concepts that provide both functionalities of fire barrier and noise reduction by stainless steel external cover and an acoustic metallic liner such as FELTMETAL™ for Muffler Exhaust and by a sandwich construction of Steel or CFRP, an acoustic liner (metallic felt metal and honeycomb) for Air Intakes. This concept has not had any significant evolution in the last aircraft programs, and existing designs have room for improvements and innovation.

This topic seeks to explore design methods for the synthesis of a potential candidate concept of an advanced rear-end component which will become the baseline configuration of the next family of commercial aircraft.

The following sections detail the activities proposed in order to accomplish this goal.

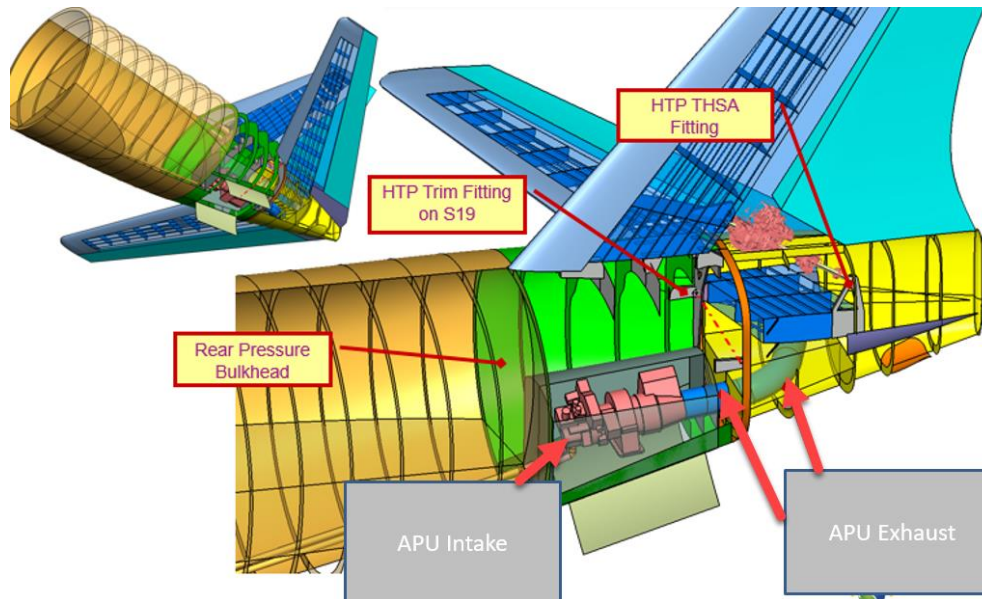

Exhaust Muffler component.

In order to fulfil the objectives laid out in the previous section the following lines of work will be covered in this proposal:

- Definition of Exhaust Muffler **thermal barrier**, which is used to insulate Exhaust Muffler from the rest of rear fuselage in terms of temperature, noise etc.
- Definition of a structural **fire barrier** capable to withstand typical loads for such component based on existing applications.
- Development of an **acoustic treatment** that is capable to provide noise reduction from the equipment that is located forwards (in this case an engine that produces jet noise). As an orientation, noise levels of existing applications as well as noise reduction targets will be used as reference.
- Construction of samples of this material assembly that will be used for Validation and Verification of a proof of concept.
- Up scaling of the component taking into account a larger installation that includes complex geometries.

Air Intake component

In order to fulfil the objectives described in the previous section, the following activities are defined in the frame of this topic

- Definition of Air Intake ducting arrangement, which is used to provide air from the exterior of the aircraft to an Air Breathing engine or a Compressor
- Definition of a structural fire barrier, capable to withstand at the same time the loads that such a component might encounter, based on existing applications.
- Development of an acoustic treatment that in combination to the fire barrier is capable to provide noise reduction, from the equipment that is located behind (in this case a compressor). As an orientation, noise levels of existing applications will be used as well as noise reduction targets.
- Construction of a sample of this material assembly that will be used for Validation and

Verification of a proof of concept.

- Upscaling of the component, taking into account a larger installation that includes complex geometries.

Functional requirements.

Muffler Exhaust - Functional requirements / Materials definitions (Layers and construction).

In a first approach, the project seeks the definition of the material(s) to be used as well as its construction in order to meet the functional requirements for an Air Exhaust Muffler application:

- Fire Proofness: the material shall be able to withstand the fire proof requirements in accordance with CS25 subpart J Fire protection.
- Noise attenuation: the material will provide noise attenuation for a range of frequencies between 100 Hz and 1 kHz seeking for a noise reduction of 15dB attenuation.
- Drainage
- Weight: as an estimation, the target surface density of the new materials (as it is intended to be used in ducting) will be below 1,0 gm/ cm²
- Reparability / Damage tolerance
- Capability to sustain direct lightning effects

A design concept will be prepared for a PDR with the use of simulation techniques or other analysis to substantiate the validation of the design.

Just for reference, the current principal configuration of an APU Exhaust Muffler is composed by:

- Shells of stainless steel (Corrosion resistance steel CRES)
- Muffler cavities
- Metallic acoustic liner such as FELTMETAL™

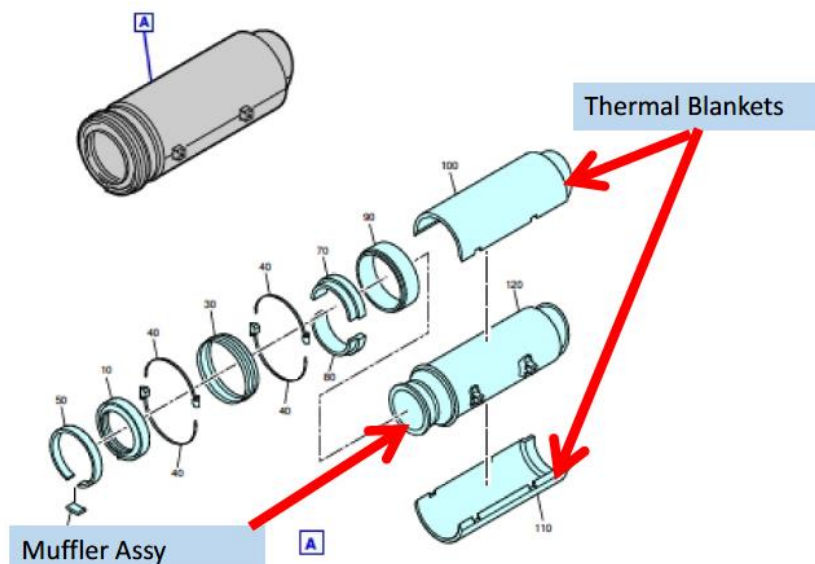

Figure 1 – Typical APU muffler components



Figure 2 – Typical thermal blanket for exhaust mufflers

Air Intake - Functional requirements / Materials definitions (Layers and construction).

In a first instance of the project, the definition of Materials to be used as well as its construction in order to meet the functional requirements is needed for an air intake application:

- Fireproof: the material shall be able to meet the Fire proof requirements in accordance with AC20-135
- Noise attenuation: the material will provide noise attenuation for a range of frequencies of 600Hz to 10KHz seeking a noise reduction of 30dB.
- Toxicity: in case of fire, the materials shall meet the Toxicity requirements in accordance with the following table:

Gas Products	Maximum Concentration combustion gas (ppm)
HCN	150
CO	1000
NO/NO2	100
SO2/H2S	100
HF	100
HCL	150

- Drainage Capability: The ducting shall be capable to evacuate the presence of any fluids. In case of fluids retention, it must provide means to evacuate them as the accumulation of hazardous quantities of flammable fluid might cause a fire hazard.
- Weight: as an estimation, the target surface density of the new materials (as it is intended to be used in ducting) will be below 0,6 gm/ cm²

In addition to these requirements, it will also be evaluated:

- Ice Formation: the materials used will incorporate passive or active methods to reduce ice formation.
- Reparability / Damage Tolerance: in case of damages in the material (FOD or Maintenance) containment of the damage, variation of properties and reparability will be evaluated.

A design concept will be prepared for a PDR where the use of simulation techniques or other analysis to substantiate the validation of the design.

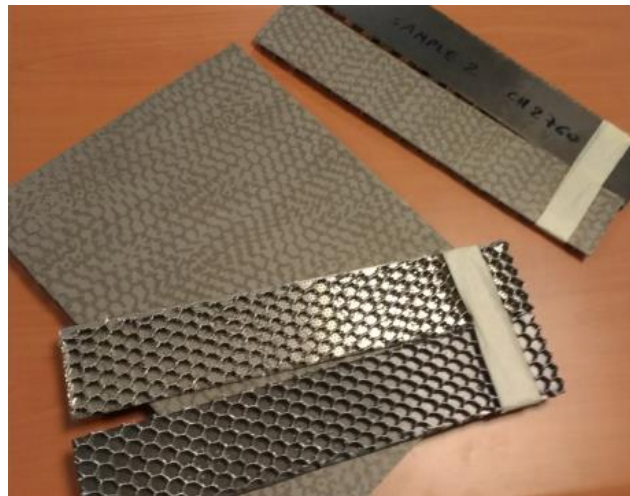

Figure 3 – Typical construction materials for noise attenuation in intakes



Figure 4 Example of Air intake ducting

Construction of prototype samples.

This activity will carry out the actual build/assembly of the material in order to perform verification and testing in a later phase. The build/assembly of the proposed material samples will be covered in a detail building instruction including the materials used as well as any adhesive or surface treatment used in the preparation. As an example, samples of 30 cm x 30 cm are used for fire testing purposes.

Testing of Samples.

In terms of materials qualification, in a first approach, a pyramid testing philosophy is followed. In this phase, testing of elements seeking a basic characterisation of the material to be used is envisaged.

The following tests are proposed:

- Fire testing according to AC20-135
- Acoustic Testing
- Drainage Testing

In order to limit the amount of coupons to be tested, any testing that has already been performed

by the applicant can be used as evidence for this phase (similarity approach).

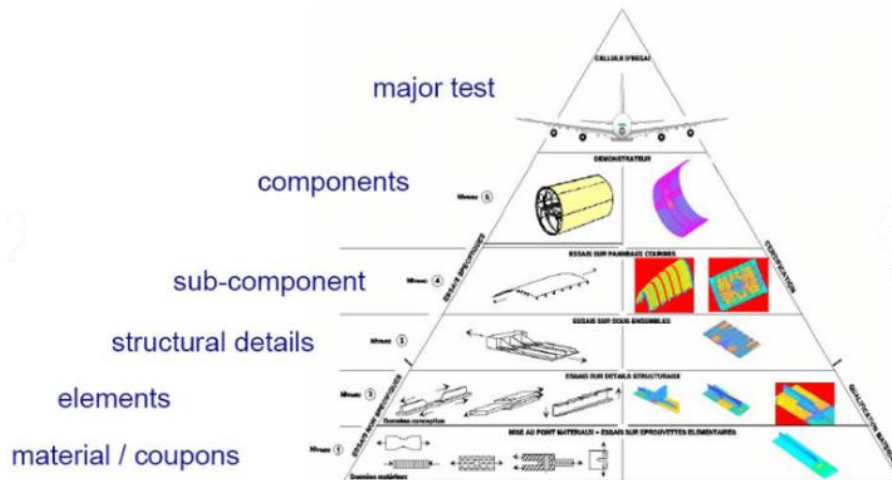

Figure 5 – Basic materials qualification pyramid

It is considered of great interest that simulation technics are used prior to the test to validate the design. Although the final tests are the only acceptable means of compliance, the use of simulation for validation purpose can reduce the number of tests. A later correlation of simulation cases versus testing can fine tune the modelling and be a candidate a means of compliance for future designs.

Based in the material properties and behaviour identified in the previous sections, a preliminary design of an exhaust muffler duct will be developed. This design must take into account the manufacturing process allowing the upscaling of the muffler production to the required rates.

The capability to manufacture the new part, as well as economic factors such as time and cost are also quite relevant. An analysis of the manufacture of the part is considered as quite relevant, as well as the capacity to repair it.

Manufacturing of the components:

The capability to manufacture the new part, as well as economic factors such as time and cost are also quite relevant. An analysis of this capability to manufacture the parts is considered as quite relevant, as well as the capacity to repair it (minor or complex repairs).

3. Major Deliverables/ Milestones and schedule (estimate)

*Type: R=Report, D=Data, HW=Hardware, RM = Review meeting, SW = Software

Deliverables			
Ref. No.	Title - Description	Type*	Due Date
01	Partner contribution detailed description (content, deliverables, planning)	Report	T0 + 3
02	Materials Build up construction Proposal. It includes the definition of the new material and how this solution provides a response to the functional requirements. A two-step approach to identify a candidate solution can be considered (i.e. PDR-CDR).	Report / Specimens	T0 + 6

Deliverables			
Ref. No.	Title - Description	Type*	Due Date
03	Validation and Verification Plan (Including modelling and test plan)	Report and tools	T0 + 9
04	Validation Models of Test Specimens (fire)	Report	T0 + 12
05	Qualification Tests Procedure	Report	T0 + 15
06	Qualification Tests Results	Test Report	T0 + 18
07	Validation and Verification Summary	Report	T0 + 22
08	Manufacturing dossier	Report	T0 + 22
09	Validation Models of Test Specimens (additional features)	Report and tools	T0 + 22
10	Final report, conclusions and recommendations	Data and Report	T0 + 24

4. Special skills, Capabilities, Certification expected from the Applicant(s)

Essential:

- Thermal barrier modelling, analysis and optimization.
- Thermal design and manufacturing capabilities.
- Acoustic modelling, analysis and optimization.
- Acoustic design and manufacturing capabilities.
- Fire thermal Testing: APU exhaust Muffler applications.
- Acoustic Testing: APU exhaust Muffler applications.
- Excellent mechanical design capability applied to aeronautical projects. Knowledge of design standards, materials and processes.
- Demonstrated mechanical design capability to design a new APU exhaust Muffler concept.

5. Abbreviations

AC	Advisory circular
APU	Auxiliary Power Unit
AMC	Alternative Means of Compliance
CDR	Critical Design Review
CFRP	Carbon Fiber Reinforced Plastic
FAA	Federal Aviation Administration
PDR	Preliminary Design Review



WP

Work Package

VI. JTI-CS2-2020-CfP11-LPA-01-93: Engine bleed jet pumps continuous behaviour modelization

Type of action (RIA/IA/CSA):		RIA	
Programme Area:		LPA	
(CS2 JTP 2015) WP Ref.:		WP 1.5.2	
Indicative Funding Topic Value (in k€):		700	
Topic Leader:	Liebherr	Type of Agreement:	Implementation Agreement
Duration of the action (in Months):	24	Indicative Start Date (at the earliest)¹⁸:	> Q4 2020

Topic Identification Code	Title
JTI-CS2-2020-CfP11-LPA-01-93	Engine bleed jet pumps continuous behaviour modelization
Short description	
The objective of this topic is to gain knowledge on physics involved inside jet pumps, and in particular to develop representative dynamic continuous behavior 1D models. Partners will have to develop such 1D models with a high level of representativity in transition phases between the different operating modes. In order to feed and tune these 1D models, the partners will have to perform CFD and physical testing.	

Links to the Clean Sky 2 Programme High-level Objectives ¹⁹				
This topic is located in the demonstration area:		Ultra-high Bypass and High Propulsive Efficiency Geared Turbofans		
The outcome of the project will mainly contribute to the following conceptual aircraft/air transport type as presented in the scene setter:		Advanced Short/Medium-range Advanced Long-range		
With expected impacts related to the Programme high-level objectives:				
Reducing CO ₂ emissions	Reducing NO _x emissions	Reducing Noise emissions	Improving EU Competitiveness	Improving Mobility
<input checked="" type="checkbox"/>	<input type="checkbox"/>	<input type="checkbox"/>	<input checked="" type="checkbox"/>	<input type="checkbox"/>

¹⁸ The start date corresponds to actual start date with all legal documents in place.

¹⁹ For further info see Chapter 1 “Introduction to the Programme Scene Setter / Objectives” with key technology themes / demonstration areas. Detailed information available in the CS2 Development Plan accessible via the Clean Sky JU Website and EC Participant Portal.

1. Background

In the frame of LPA Platform 1 WP1.5.2, the topic manager studies innovative bleed concepts for Ultra-High Bypass Ratio (UHBR) engine severe environment. This new generation of engines gives rise to new challenges specifically on bleed systems. It is essential today to develop new technologies enabling lowering bleed working temperature and reducing the size of the pre-cooler, for integration purpose. A promising solution is a mixing system using a jet pump which will also allow reducing the total intake on the engine and thus reducing fuel consumption.

Indeed, in order to take benefit of the dynamic air (pressure and flow), some new bleed architectures include a jet pump: this equipment takes into account the available amount of motion. Air entrainment is performed by viscosity.



The present Topic objective is to focus on the modelling of the jet pumps. Several geometries will be specified by the Topic Manager at the beginning of the project.

Basic modelling of jet pump is well described in the literature, and well known for the normal operating phases. The aim of this project is to establish a robust, efficient and accurate model taking into account the whole operational envelop with a strong focus on transition phases. These studies can be carried out by CFD analysis or nodal approaches.

Nevertheless, to perform a complete system analysis (integrated equipment in static and dynamic studies), it is essential to identify and modelize:

- the transition phases (between two operating modes);
- the off-design modes (reverse flow or pressure, zero flow condition).

The different operating and off-design modes to be considered are:

- secondary flow induced by primary flow,
- primary flow without secondary flow,
- secondary flow without primary flow,
- reverse flows,
- no flow conditions.

2. Scope of work

As of today, only static behaviour of a jet pump can be predicted in 0D-1D. To be able to introduce such a technology in an innovative bleed system, it is necessary to be able to predict its behaviour during transitory phases "continuously", between all the operating modes, to be able to build its control laws.

The studies will be split in static and dynamic analysis based on a number of tests defined through Design of Experiment (DoE) methodology and performed on a minimum of three (3) different

prototypes. Air supply test conditions will be under high pressure (up to 5 bars) at a temperature up to 200°C with rapid pressure variation (e. g. going from 2 to 4 bars \leq 1 s).

Typically, mixing diameter for jet pump is ranging from 35 mm up to 100 mm depending on the application. Flange will be ranging from 2 to 6 inches in diameter, length from 350 mm up to 1 meter.

The following task structure is proposed.

Tasks		
Ref. No.	Title – Description	Due Date
WP1	Jet Pumps behavior static analysis	
WP1.1	CFD static analysis for each operating, off-design modes and transitions	T0+6M
WP1.2	DoE testing on instrumented prototypes - Static	T0+8M
WP1.3	OD-1D Modelling	T0+10M
WP2	Jet Pumps behavior dynamic analysis	
WP2.1	CFD analysis for transition phases (between two modes)	T0+12M
WP2.2	DoE testing on instrumented prototypes - Dynamic	T0+16M
WP2.3	OD-1D Modelling	T0+20M
WP3	Jet Pumps modelling validation	
WP3.1	OD-1D Static Validation	T0+12M
WP3.2	OD-1D Dynamic Validation	T0+24M

WP1 Jet pump behavior static analysis

WP1.1 CFD static analysis for each operating, off-design modes and transitions: In order to establish the operating modes modelling in static conditions, CFD analysis must be performed on different geometries that will be provided by the Topic Manager at the beginning of the project. This study must cover all operating and off-design modes previously detailed. Moreover, the transition phases between the different operating modes will require a large number of static calculations to better understand the behavior during these phases.

CFD results will be compared to tests results obtained in WP1.2.

WP1.2 DoE testing on instrumented prototypes – Static: Based on Topic Manager Specification, the partners will have to manufacture different jet pumps prototypes. DoE shall be established based on the following parameters: primary and secondary flows inlet pressures and temperatures; back pressure. Prototypes will then be tested against the defined DoE.

WP1.3 OD-1D Modelling: Based on the CFD results, a first static OD-1D analytical model will be developed. The Multiphysics platform Dymola shall be used to develop specific modules with Modelica language.

The topic manager will provide its own libraries to the partners so that they can build the jet pump model.

In a second step, to derive an efficient and robust numerical model, surrogate modelling methodologies shall be used such as Response Surface Methodology (RSM) or new data analytics methodology such as deep learning.

WP2 Jet Pump behavior dynamic analysis

WP2.1 CFD analysis for transition phases (between two modes): Jet pumps are to be used in bleed systems to be controlled by the Topic Manager in closed loop conditions (temperature, flow and pressure). Hence, dynamic jet pumps analysis is also necessary (0D system model/CFD coupling; 0D system model could be provided by the Topic Manager). The static CFD analysis has to be complemented by a dynamic CFD study to cover transient conditions, for the different geometries provided by the Topic Manager.

WP2.2 DoE testing on instrumented prototypes - Dynamic: DoE shall be established based on the following parameters: primary and secondary flows inlet pressures, as functions of time, for fixed temperatures; back pressure as a function of time. Prototypes manufactured in WP1.2 will then be tested against the new defined DoE.

WP2.3 OD-1D Modelling: By using the same approaches followed for static conditions (WP1.2), a 0D-1D dynamic model will be established. In particular, the transient model shall be validated in term of accuracy, robustness and computational time. The bleed system tests scenarii will be provided by the Topic Manager covering the whole operating envelop and modes.

WP3 Jet Pumps modelling validation

WP3.1 OD-1D Validation: To finalize the static approach, the calculation results (0D-1D) will be compared to tests results obtained in WP1.2. All the operating and off-design modes must be covered.

WP3.2 OD-1D Validation: To finalize the dynamic approach, the calculation results (0D-1D) shall be compared to tests results. All the operating and transient conditions must be covered, including operating and off design modes.

3. Major Deliverables/ Milestones and schedule (estimate)

*Type: R=Report, D=Data, HW=Hardware

Deliverables			
Ref. No.	Title - Description	Type*	Due Date
D1.1	Jet pump model design description and static behavior simulation report	R	T0+10M
D1.2	Static library (Dymola models)	D	T0+10M
D2.1	Jet pump model design description and dynamic behavior simulation report	R	T0+20M
D2.2	Dynamic library (Dymola models)	D	T0+20M
D3.1	Static validation report	R	T0+12M
D3.2	Dynamic validation report	R	T0+24M

Milestones (when appropriate)			
Ref. No.	Title - Description	Type*	Due Date
M1	Static modelling completion review	D	T0+10M
M2	Dynamic modelling completion review	D	T0+20M



4. **Special skills, Capabilities, Certification expected from the Applicant(s)**

Essential:

- Fluid mechanics (steady and unsteady, compressible flow)
- OD-1D modelling (Dymola/Modelica) for library and models
- Dymola/Modelica tool
- Data analytics framework / environment
- Testing facilities featuring high pressure (up to 5 bars) air supply at a temperature up to 200°C; enabling rapid pressure variation (e. g. going from 2 to 4 bars \leq 1 s)

5. **Abbreviations**

DoE	Design of Experiment
CFD	Computational Fluid Dynamics
RSM	Response Surface Methodology
UHBR	Ultra-High Bypass Ratio

VII. JTI-CS2-2020-CfP11-LPA-01-94: Installed UHBR Nacelle Off-Design Performance Characteristics.

Type of action (RIA/IA/CSA):		RIA	
Programme Area:		LPA	
(CS2 JTP 2015) WP Ref.:		WP 1.5.2	
Indicative Funding Topic Value (in k€):		3000	
Topic Leader:	Rolls-Royce	Type of Agreement:	Implementation Agreement
Duration of the action (in Months):	30	Indicative Start Date (at the earliest)²⁰:	> Q4 2020

Topic Identification Code	Title
JTI-CS2-2020-CfP11-LPA-01-94	Installed UHBR Nacelle Off-Design Performance Characteristics

Short description
UHBR engines require novel advanced low drag nacelles, and close coupled wing installations, outside current design experience. The Project objective is investigate how novel UHBR Nacelles perform under off design conditions, (take off high lift, at windmill and idle), and provide a detail understanding of the complex flow separation physics to assist in interpreting FTB results. A detailed understanding of the factors influencing external flow separation mechanism will enable improved design rules, prediction methodologies and geometric enhancements to be developed. This requires utilising a range of CFD techniques to predict external cowl separation mechanisms and Wind Tunnel Component testing with high fidelity instrumentation to measure the detail flow physics of the external cowl under off design windmill high incidence conditions; and installed nozzle suppression under take off windmill and idle conditions to provide CFD validation data. Jet flap interaction Noise understanding also needs to be enhanced to aid interpretation of FTB results. Acoustic measurements should be undertaken during the same test series; with an aligned CAA (computational aero acoustics) study to extrapolate the test results to the free flight environment.

Links to the Clean Sky 2 Programme High-level Objectives ²¹				
This topic is located in the demonstration area:		Advanced Engine/Airframe Architectures		
The outcome of the project will mainly contribute to the following conceptual aircraft/air transport type as presented in the scene setter:		Advanced Long-range Advanced Short/Medium-range		
With expected impacts related to the Programme high-level objectives:				
Reducing CO ₂ emissions	Reducing NO _x emissions	Reducing Noise emissions	Improving EU Competitiveness	Improving Mobility
<input checked="" type="checkbox"/>	<input type="checkbox"/>	<input type="checkbox"/>	<input type="checkbox"/>	<input type="checkbox"/>

²⁰ The start date corresponds to actual start date with all legal documents in place.

²¹ For further info see Chapter 1 "Introduction to the Programme Scene Setter / Objectives" with key technology themes / demonstration areas. Detailed information available in the CS2 Development Plan accessible via the Clean Sky JU Website and EC Participant Portal.

1. Background

Reducing fuel burn and CO₂ emissions to meet the future EU ACARE and Flightpath 2050 goals is a major factor in the design of the UltraFan[®] next generation engines. Adoption of an UltraFan[®] low specific thrust engine cycle to maximise propulsive efficiency leads to an increase in engine fan diameter and a consequential increase in nacelle size & weight with current design rules.

To fully enable the potential benefits of the UltraFan[®] compact low drag cruise advanced nacelles, the nacelles are required to be close coupled with the wing, for structural efficiency and weight saving opportunities. Compact nacelles optimised for low cruise drag will also be required to operate at 'off design' windmill and idle conditions under Take-Off high lift configurations. Windmilling characteristics under cruise engine-out and the concomitant ETOPS diversion case will also need to be accounted for. Currently, the design sensitivities of novel compact UHBR nacelles at 'off design' conditions are not well understood, and current CFD predictive capabilities to interpret measured data results from the UltraFan[®] FTD nacelle are not validated against representative geometry.

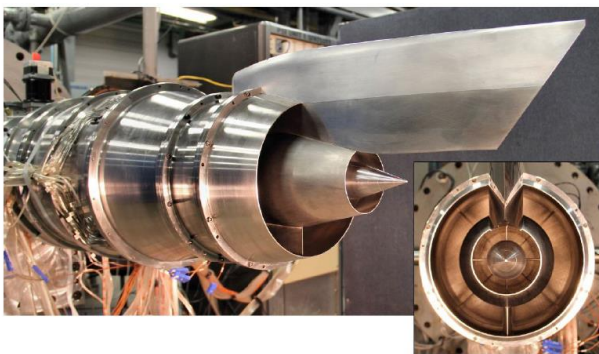

Evaluation of Novel UHBR Nacelles under Low Speed 'Off Design' Conditions

2. Scope of work

The aim of this programme is to enable the detail understanding of the key design sensitivities for compact UltraFan[®] nacelles under 'off design' conditions; requiring accurate prediction of 'off design' streamtube flows and external cowl geometric sensitivity. This requires a detail understanding of the flow physics associated with external cowl separation under high incidence climb conditions, to aid

understanding of the UltraFan® FTD flight test results with a novel nacelle. High Incidence external cowl separation should be investigated at wind mill flows under second segment climb conditions, and maximum angle of attack at idle conditions. The work should also address the cruise engine out as well as cruise phase windmill diversion phase. These conditions should be the subject of a rig and CFD study as detailed below. In addition enhancement of jet interaction on close coupled configurations is necessary.

This programme of work requests significant innovation in five key areas to aid interpretation of the UltraFan® Flight Test results:

- CFD assessment of a range of novel UHBR nacelle profiles under 'off design' conditions, requiring parametric geometric modelling & optimisation, and validated CFD analysis tools to create the candidate designs.
- A highly instrumented mid TRL nacelle section test rig to take detail measurements of the key flow physics, which is currently not understood, for CFD validation.
- High accuracy test measurement of installed fan and core exhaust Cd suppression at low flows on representative separate jet exhaust geometry under Take-Off and cruise conditions.
- High order CFD calculations to predict complex external nacelle separation under 'off design' conditions
- Measurement and CAA prediction of installed jet flap interaction on a separate jet nozzle test rig.

The CFD and CAA codes and methods chosen for design and analysis shall be mutually agreed with the topic manager; either commercially available codes, or an agreed alternative. The test rig concepts shall be mutually agreed with the topic manager.

Using appropriate CFD predictive techniques, and focused component rig tests to provide high fidelity validation data, this programme will develop predictive techniques to assist in interpreting UltraFan® FTD flight test results. In addition design rules and methods should be developed to aid enhancement of 'off design' novel compact UHBR nacelle design rules.

The programme of work will require the design and CFD evaluation of a range of candidate compact 3-D UHBR nacelles at 'off design' (high incidence windmill & idle and cruise windmill diversion) conditions to provide a range of test candidates with different geometric configurations and predicted flow separation physics. These should be representative of compact UBHR nacelle designs for cruise. The 'off design' performance of the nacelles should be evaluated via a series of RANS CFD models over a range of representative Reynolds Numbers. The RANS CFD should be used to select suitable test candidates for test investigation using a nacelle cowl aerofoil section, which can reproduce the key flow physics related to external cowl separation, including the effect of different pylon styles, Reynolds number, turbulence and surface roughness.

A CFD study will be required to determine the optimum shaped wall design, to correctly model the local streamline curvature, and external cowl aerofoil section, to reproduce the external cowl high incidence windmill (second segment climb) and idle (maximum angle of attack) flow physics around the point of flow separation, at flight Mn's between $M=0.25$ and 0.30 . In addition the cruise and diversion windmill conditions should also be reproduced at flight Mn's between $M=0.5$ and 0.80 .

The shaped wall external aerofoil rig should be used to take high fidelity measurements of the shock field using Schlieren imagery, local external cowl near wall boundary layer velocity profiles (<0.2 mm from surface) using Laser Doppler Annemometry (LDA), surface pressure distributions (using static tappings and PSP), Oil flow visualisation of surface flows, and surface unsteady pressure measurement of shock oscillation. The rig cowl aerofoil section should be designed to enable the rapid testing of a

range of cowl profiles (5 or more cowl sections are requested); a rig working section height of > 200 mm is envisaged. The rig should have the ability to test incidence levels representative of Take-Off windmill (second segment climb), and maximum angle of attack at idle flows. The rig should have the ability to test variation in capture streamtube intake flows. It is desired that the rig can also investigate the influence of surface roughness on cowl flow stability to provide future design rules for manufacturing tolerances. A key element of building understanding of the flow separation characteristics under high incidence 'off design' operation is the state of the boundary layer. Suitable techniques, such as infrared thermography, should be used to investigate boundary layer transition over a range of representative Reynolds numbers for a UHBR engine under Take-Off conditions. The rig will need to be pressurised (up to 3 bar) to achieve the required Reynolds Number range, representative of a Take-Off regime (Re from 0.45 to 1.4E6) based on nacelle aerofoil thickness

In parallel a high fidelity CFD study should be conducted using a range of methods to predict the rig complex flow physics including transition behaviour. A key consideration is the ability to predict separation onset which may arise through a variety of mechanisms given the range of Mass Flow Capture Ratios (MFCR), local incidence and flight M_n . As well as separation onset, the development of the boundary layer and surface shear stress is also of interest. Consequently the CFD approaches should include a range of turbulence models, as well as unsteady methods. It is envisaged that possible approaches could include RANS models including Reynolds Stress Model (RSM), Delayed Detached Eddy Simulation (DDES) and Large Eddy Simulation (LES).

Both the high fidelity CFD and rig results should be used to calibrate RANS methods to predict external nacelle separation behaviour. The assessment of the capability of RANS methods relative to the higher fidelity and experimental data is important as design and optimisation studies are likely to remain as RANS based methods in the UltraFan[®] timescales.

A major contributor to external cowl windmill and idle design is knowledge of the design capture streamtube. For close coupled installed UHBR nacelles under high lift Take-Off conditions there is currently a lack of accurate validation data of fan nozzle suppression effects at low mass flows for close coupled installed configurations. An experimental rig test with independently variable fan and core flow is thus required of an 'industry standard' exhaust nozzle (the AIAA DSFR would be a suitable test candidate), combined with a high lift wing simulator, on a rig with high accuracy flow measurement to determine fan nozzle C_d characteristics at idle and windmill flows over Take-Off M_n 's from $M=0.20$ to 0.5. The test should include appropriate instrumentation and the use of Pressure Sensitive Paint (PSP) to provide high resolution data for CFD calibration. Other novel measurements approaches can be proposed.

To provide the capture streamtube for idle and windmill conditions an ability to conduct cycle modelling and define representative intake and exhaust geometry for a UHBR engine will be required. RANS CFD calculations, conducted to determine how accurately the exhaust suppression test results can be predicted, can be proposed.

For close coupled UHBR engines it is necessary to understand the design constraints imposed by the jet-flap interaction noise at Take-Off and landing in high-lift configuration, along with the noise levels on the aircraft fuselage in cruise produced by the jet mixing or at higher fan-nozzle pressure ratios by the shock-cell associated broadband jet noise.

In addition for close coupled UHBR engines it is necessary to understand jet flap interaction Noise under high lift conditions. Testing under cruise conditions with a clean wing would be advantageous. A jet rig

test at Take-Off and approach flow rates using a representative nozzle and wing simulator is required to provide further understanding and data to calibrate methods ahead of the FTD flight campaign. A separate jet exhaust system nozzle, (the AIAA DSFR would be suitable), should be tested with a wing simulator, instrumented with an array of 30 Kulites, in a wind tunnel.

To verify the physical understanding and the design constraints the unsteady flow and acoustic fields should be predicted using existing and validated time- and scale-resolving acoustic numerical simulation methods such as Large Eddy Simulation (LES) or Detached Eddy Simulation (DES) with Ffowcs Williams and Hawkings (FWH) acoustic analogy. Simulations at least 3-off Take-Off conditions and 3-off cruise conditions should be performed. The simulations should quantify the absolute jet-flap interaction noise levels of the selected nacelle design at Take-Off conditions and the risks or the noise reduction potential in cruise on the aircraft fuselage.

To optimise and to reduce technical risks in the test experimental setup a further simulation of the installed engine with baseline nacelle should be conducted and analysed. The Topic manager will guide the data analysis using existing experience.

To calibrate the time- & scale-resolving numerical simulations, acoustic measurements should be conducted simultaneously to the aerodynamic measurements. If simultaneous aerodynamic and acoustic measurements are not possible the required modification in the test setup for the acoustic measurements should be small.

To verify the suitability of the facility for acoustic measurements the noise levels predicted by the acoustic numerical simulations for the baseline nacelle at Take-Off and in cruise should be compared with the expected wind tunnel background noise and the nozzle rig self-noise. The measurement locations should mimic sensors located on the fuselage, wing and pylon on an engine flying test bed (FTD). About 30 dynamic sensors with a frequency of at least 5kHz full-scale are needed. The sensor locations will be guided by the Topic manager.

The post-processing of the dynamic sensors should allow separating hydrodynamic and acoustic pressure fluctuations. The measured and simulated aerodynamic and acoustic data should be compared and the differences due to systematic and statistical errors in the measurement/experimental setup vs. numerical simulation discussed and quantified. The sensors setup should be critically reviewed and an optimised sensor arrangement for a test on an engine flying test bed (FTD) be proposed. This work may be based on predictions using an open source aircraft geometry such as the NASA CRM, or alternate configuration proposed by the topic manager.

A programme to evaluate and verify novel UHBR nacelles under low speed high lift 'off design' conditions will provide:

- Detailed understanding of installed UHBR nacelle off design performance to aid interpretation of the UltraFan® FTD results.
- Validated aerodynamic design rules for external cowl separation under low speed high lift conditions.
- Demonstration of the influence of the close coupled UHBR nacelle installed exhaust suppression under low speed high lift operation at low flows.
- Demonstration of design constraints imposed by noise at Take-Off and in cruise
- Enable a mid TRL rig for future external nacelle research.

Tasks		
Ref. No.	Title - Description	Due Date
1	Agree nacelle & exhaust design envelope, and test conditions	T0 + 3 months
2	CFD study to determine nacelle rig test configuration	T0 + 6 months
3	Conduct nacelle design study to deliver candidate designs for test	T0 + 14 months
4	Nacelle Rig test design and manufacture complete	T0 + 18 months
5	Nozzle suppression rig test complete	T0 + 18 months
6	Nacelle Rig test phase complete	T0 + 24 months
7	Nozzle Jet Flap Test complete.	T0 + 24 months
8	High Fidelity CFD calculations complete	T0 + 24 months
9	Geometry and RANS prediction guidelines for external cowl separation.	T0 + 30 months

Task 1

- Review of design trends for novel UHBR nacelles and off design operating conditions to bound design space and test conditions.
- Agree nacelle design & CFD proposals, and test rig concepts with topic manager
- Agree nozzle rig test suppression and noise proposal with topic manager

Task 2

- Conduct analysis of 3-D nacelle flow field under off design conditions to determine the rig concept design to produce representative flow physics at 'off design' conditions.

Task 3

- Conduct design study using a range of RANS models to determine test candidate designs. Down select candidate designs.
- Confirm nacelle test rig aerodynamic configuration.
- Confirm nozzle test rig aerodynamic and Noise configuration
- Conduct idle and windmill cycle modelling for UHBR configuration to set design flows for rig and CFD test.
- CAA Numerical simulation with baseline nacelle at Take-Off and cruise

Task 4

- Complete Design and Manufacture of nacelle cowl mid TRL test rig.
- Finalise and down select appropriate instrumentation to characterise external cowl separation characteristics.
- Assessment of suitability of jet rig facility for acoustic measurements and definition of acoustic sensor arrangement.
- Complete design modifications for Nozzle suppression and jet noise test rig.

Task 5

- Conduct test of nozzle test rig with wing simulator over range of representative idle and wind mill test conditions

Task 6

- Complete nacelle cowl profile test of selected candidate designs.
- Deliver high fidelity data set for RANS CFD calibration.
- Provide detailed test summary report

Task 7

- Conduct Jet Rig acoustic test over range of Take-Off and cruise operating points.
- Complete jet flap interaction acoustic test.
- Calibration of acoustic numerical simulations with measurements and error analysis completed
- Deliver test results for CFD and empirical methods calibration

- Provide detail test summary report

Task 8

- Complete a range of RANS and higher fidelity CFD calculations of nacelle rig test configuration.
- Complete a range of RANS and higher-fidelity CFD calculations of a 3D engine standard nacelle configuration.
- Deliver summary test results for RANS CFD calibration
- Deliver CAA prediction summary for jet flap interaction test

Task 9

- Deliver geometry design guidelines for UHBR novel nacelle design rules for 'off design' performance.
- Deliver validated design rules for CFD prediction of nacelle 'off design' cowl separation for UHBR designs
- Deliver summary of Noise Jet flap interaction test and CFD predictions
- Deliver guidance on optimised sensor setup on a flying test bed (FTD) for the validation of acoustic numerical simulations
- Final report of programme findings

3. Major Deliverables/ Milestones and schedule (estimate)

*Type: R=Report, D=Data, HW=Hardware

Deliverables			
Ref. No.	Title - Description	Type*	Due Date
D1	Work Plan for all tasks, Nacelle & Exhaust design and evaluation matrix summary	Plan	T0 +3 months
D2	CFD results to define nacelle test rig concept	Report	T0 + 6 months
D3	Numerical simulation with baseline nacelle at Take-Off and cruise completed	Report	T0 + 10 months
D4	Candidate nacelle concepts for rig test and RANS CFD summary	Report + CADD definition	T0 + 14 months
D5	Definition of nozzle suppression + Jet Noise test rig concept. Assessment of suitability of facility for acoustic measurements and definition of acoustic sensor arrangement completed	Report	T0 + 14 months
D6	Test hardware and instrumentation for Nacelle test rig.	Hardware	T0 + 18 months
D7	Jet Rig hardware for aero and acoustic test complete	Hardware	T0 + 22 months
D8	Nacelle test complete and summary report. Noise numerical simulations completed.	Report + Data	T0 + 24 months
D9	Exhaust suppression and jet Noise test results and summary report	Report + Data	T0 + 24 months
D10	High fidelity and RANS CFD results complete	Report + Data	T0 + 28 months
D11	CAA acoustic prediction of jet rig complete. Calibration of acoustic numerical simulation vs. Test data complete.	Report	T0 + 28 months
D12	Final report and design guidelines	Report	T0 + 30 months

Milestones (when appropriate)			
Ref. No.	Title - Description	Type*	Due Date
M1	Work Plan agreed	Report	T0 + 3 months
M2	Nacelle and Exhaust rig test concept review	Review	T0 + 6 months
M3	Nacelle configurations for test down select	Review	T0 + 12 months
M4	Model and instrumentation definition for manufacture.	Review	T0 + 12 months
M5	Wind tunnel test model manufacture complete	Hardware	T0 + 18 months
M6	Wind tunnel test complete	Data	T0 + 24 months
M7	Post test CFD validation and design rules complete	Report	T0 + 30 months
M1	Work Plan agreed	Report	T0 + 3 months

4. Special skills, Capabilities, Certification expected from the Applicant(s)

The applicant shall describe its experience/capacities in the following subjects:

Essential:

- Have substantial technical knowledge in the domain of the proposed tasks
- Demonstrated expertise in project participation, international cooperation, project and quality management
- Established track-record in the design and analysis of UHBR novel nacelle concepts, under cruise and 'off design' conditions.
- Demonstrated expertise, in the application of parametric design and optimisation, to underwing high bypass ratio turbofan nacelles for large civil jet engines.
- Understanding of current UHBR nacelle design objectives and 'off design' challenges for novel nacelles, and installed nozzle suppression prediction.
- Proven ability to rapidly generate aerodynamic quality parametric 3-D nacelles suitable for manufacture.
- Proven ability to conduct installed separate jet nacelle and exhaust CFD analysis using methods that are already validated against industry standard test cases.
- Established track record in understanding complex shock physics and boundary layer interaction of complex aerodynamic geometry.
- Demonstrated ability to design novel mid TRL test rigs to investigate pertinent shock and boundary layer transition physics, over a range of Reynolds numbers using high fidelity instrumentation and delivering test results to industry.
- Proven ability test industry standard separate jet exhaust nozzles with high lift wing simulation in a wind tunnel with a working section >2.0m with a nozzle diameter of approx 200 mm) at MN up to M=0.30, with high fidelity flow measurement
- Demonstrated ability to conduct jet acoustic testing with dynamic instrumentation.
- Proven ability to conduct Engine Cycle modelling to define a UHBR engine cycle for idle & windmill and model re-matching effects due to installation effects.
- A proven ability to apply RANS and High Fidelity CFD methods for complex flows with boundary layer separations.
- Proven ability to conduct installed jet noise CAA modelling on large turbofan engines, and comparing results to experimental data.

- Expertise to develop novel wind tunnel measurement techniques to enhance the understanding of nacelle and exhaust flow; with focus on surface pressure distributions, surface boundary layer velocity profiles & transition using thermography and shock topography using Schlieren techniques. Demonstrated experience in applying steady and dynamic static pressure measurements, steady & unsteady PSP {pressure sensitive paint} for surface pressures, LDA for detail boundary layer measurements close to a surface and surface flow visualisation techniques.
- Proven capability of conducting aero-acoustic numerical simulations and acoustic measurements in wind tunnels should be demonstrated.

Advantageous:

- Proven achievement record showing knowledge is recognised by scientific community

5. Abbreviations

CFD	Computational Fluid Dynamics
Mn	Mach Number
CADD	Computer Aided Design
PSP	Pressure Sensitive Paint
LDA	Laser Doppler Annemometry
CAA	Computational Aero Acoustics
DFSR	AIAA 'open source' Dual Separate Jet Nozzle .
UHBR	Ultra High Bypass Ration (Engine)
FTD	Flight Test Demonstrator
TRL	Technical Readiness Level –
RSM	Reynolds Stress Model
CAA	Computational Aero Acoustics
DES	Detached Eddy Simulation
DDES	Delayed Detatched Eddy Simulation
LES	Large Eddy Simulation
MFCR	Mass Flow Capture Ratios

VIII. JTI-CS2-2020-CfP11-LPA-01-95: Passive Actuated Inlet for UHBR engine ventilation

Type of action (RIA/IA/CSA):		IA	
Programme Area:		LPA	
(CS2 JTP 2015) WP Ref.:		WP 1.5.2	
Indicative Funding Topic Value (in k€):		800	
Topic Leader:	Airbus	Type of Agreement:	Implementation Agreement
Duration of the action (in Months):	27	Indicative Start Date (at the earliest)²²:	> Q4 2020

Topic Identification Code	Title
JTI-CS2-2020-CfP11-LPA-01-95	Passive Actuated Inlet for UHBR engine ventilation
Short description	
While future engine tends to be hotter and sources of cooling to be fewer and more expensive, a passive actuated inlet system offers a way of controlling the engine ventilation and cooling needs without any architectural changes and active control means. By doing so, engine performance could be improved by an optimized cooling through ventilation, without any big architectural modification. Main activities of this topic are selection and characterization of appropriate materials, as shape memory alloy and passive two phase heat transport system, perform prototype modelling, design and manufacturing, followed by full demonstrator integration and tests.	

Links to the Clean Sky 2 Programme High-level Objectives²³				
This topic is located in the demonstration area:		Advanced Engine/Airframe Architectures		
The outcome of the project will mainly contribute to the following conceptual aircraft/air transport type as presented in the scene setter:		Advanced Short/Medium-range		
With expected impacts related to the Programme high-level objectives:				
Reducing CO₂ emissions	Reducing NO_x emissions	Reducing Noise emissions	Improving EU Competitiveness	Improving Mobility
<input checked="" type="checkbox"/>	<input type="checkbox"/>	<input type="checkbox"/>	<input checked="" type="checkbox"/>	<input type="checkbox"/>

²² The start date corresponds to actual start date with all legal documents in place.

²³ For further info see Chapter 1 “Introduction to the Programme Scene Setter / Objectives” with key technology themes / demonstration areas. Detailed information available in the CS2 Development Plan accessible via the Clean Sky JU Website and EC Participant Portal.

1. Background

With the increase of By-Pass Ratio (BPR), future engines are heading to great challenges on ventilation and thermal regulation of the engine compartments and especially the engine core zone. Indeed, in order to increase BPR, the by-pass mass flow needs to be increased. To do so, a larger and slower fan is required which tends to lower Fan Pressure Ratio (FPR), limiting the dynamic pressure available downstream of the fan, where the air is usually tapped in order to ventilate the engine core zone. In the same time, the engine primary cycle is optimized by engine manufacturers days after days which tends to increase engine temperatures. The combination of these two adverse effects leads to an increase of heat management issues inside the engine core zone where more and more sensitive equipment are installed.

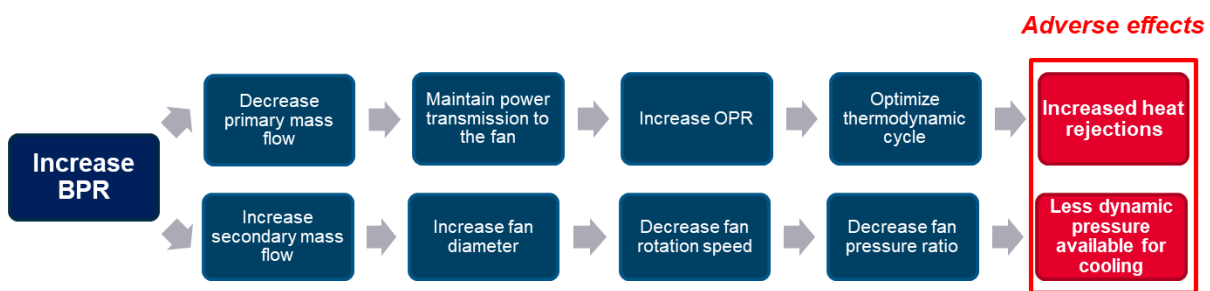

Figure 1: The BPR effect on engine core zone ventilation and thermal

In order to ensure equipment's integrity inside the engine core zone, without developing entirely new heat management solution, the engine core zone ventilation would have to be increased. One of the drawbacks of increasing the engine core zone ventilation is that the air used for ventilation is usually taken from the by-pass, which decrease the overall engine performance.

In order to limit the engine core zone ventilation impact on engine's performance, one solution consists of modulating it: the inlet is open only when the engine core zone needs cooling, otherwise it is closed in order to avoid any performance losses from unnecessary ventilation and cooling. To do so, active actuated inlet have been used on several engines in the past, however the actuation of such a system comes with an increase of weight, costs, and a decreased of performance and reliability.

For this reason, Airbus has been working during the past years on a patented passive actuated inlet for core zone ventilation, allowing the passive modulation of the engine core zone ventilation through the monitoring of a thermally sensible area.

The system is based on two disruptive technologies: memory shaped alloy and heat pipes.

The first part of the system is composed by a flush inlet linked to a memory shaped spring which expands (or retract) when subjected to a certain temperature level. When expanded (or retracted), this memory shaped spring brings the flush inlet to an open position, allowing fresh air to flow inside the core zone. When the temperature decrease and pass below the defined spring temperature level, the flush inlet comes back to a closed position, avoiding any air to flow inside the engine core zone and therefore, limit the performance losses due to engine core zone ventilation.

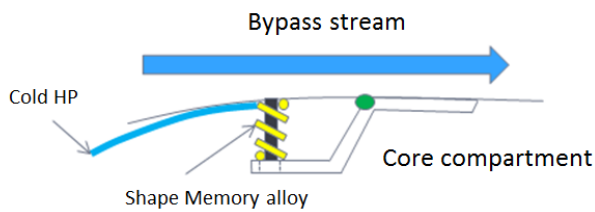

Figure 2: Passive actuated inlet in closed position (cold heat pipe)

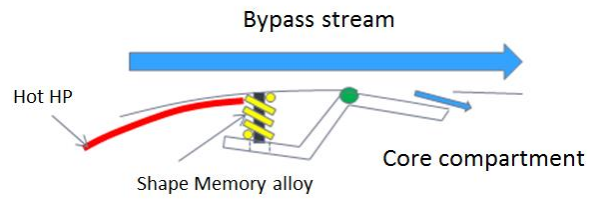

Figure 3: Passive actuated inlet in open position (hot heat pipe)

The second part consists of a heat pipe connected to the memory shaped spring, acting as a passive measurement mean. Indeed, the heat pipe can be placed in very strategic and sensitive areas of the engine core zone and will enable the control of the memory shaped spring using the temperature level of a sensitive area distant from the ventilation inlet.

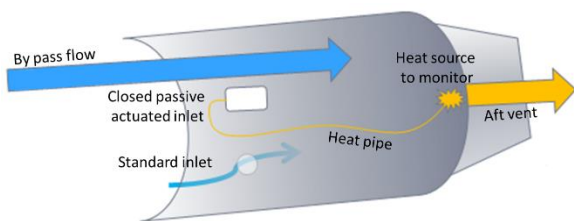

Figure 4: Closed passive actuated inlet

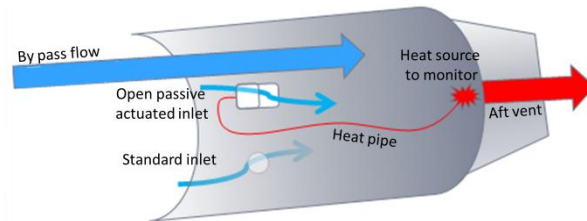

Figure 5: Open passive actuated inlet

Therefore, the complete system allows the passive modulation of the engine core zone ventilation and, as a consequence, the thermal management of sensitive areas of the engine core zone as close as possible from the cooling needs of these areas.

This system has several advantages, the first and most important being that the system is completely passive. Having a passive system tends to increase reliability and diminish maintenance costs. Also, since the inlet is entirely regulated by the thermally sensible area's needs of cooling, the ventilation and the thermal regulation of the zone is as close as possible from the real needs, avoiding any unnecessary performance losses.

2. Scope of work

The system will be implemented in the engine core compartment on the nacelle outer fixed structure. The maximum engine core compartment air temperature surrounding the system is ranged between 100°C to 200°C. The ventilation inlet section to regulate is about 1000mm². The device shall obviously be neutral in term of secondary flow aerodynamic penalties. Delta pressure in between secondary flow and engine core compartment is below 0.8bars.

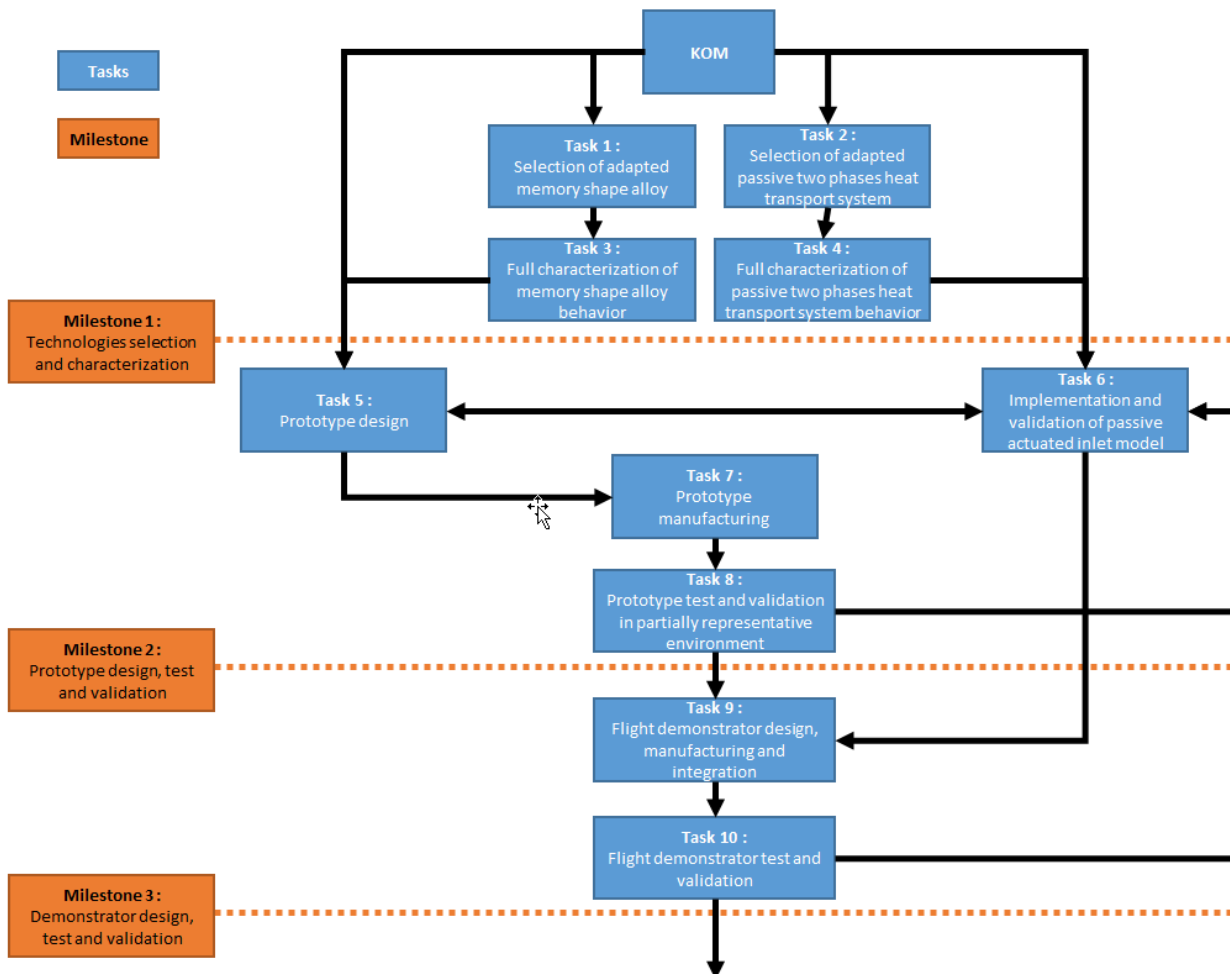

Figure 6: Project's flowchart

Tasks		
Ref. No.	Title – Description	Due Date
T1	Selection of best memory shape alloy	T0+3M
T2	Selection of best heat pipe technology	T0+3M
T3	Full characterization of memory shape alloy behavior	T0+6M
T4	Full characterization of heat pipe behavior	T0+6M
T5	Implementation and validation of passive actuated inlet model	T0+8M
T6	Prototype design and manufacturing	T0+11M
T7	Prototype test and validation in partially representative environment	T0+14M
T8	Ground / Flight demonstrator design, manufacturing and integration	T0+20M
T9	Ground / Flight demonstrator test and validation	T0+27M

A first phase of ground qualification tests is foreseen to simulate the real environment such as vibrations, freeze, pressure, static and dynamic conditions. A second phase could integrate flight tests on a UltraFan engine demonstrator where the technology is intended to be assessed on real environment as well to verify and validate also a correct dynamic time response of the passive system.

3. Major Deliverables/ Milestones and schedule (estimate)

*Type: R=Report, D=Data, HW=Hardware, SW=Software

Deliverables			
Ref. No.	Title - Description	Type*	Due Date
1	Selection of best memory shape alloy Based on the physical and environmental conditions provided by the Topic Manager, a trade-off evaluation is awaited to select the best memory shape alloy able to meet the requirements based on literature assumptions.	R	T0+3M
2	Selection of best heat pipe technology It exists a lot of different heat pipe technologies considering different working fluid and architecture. Based on the physical and environmental conditions provided by the Topic Manager, a trade-off evaluation is awaited to select the best memory shape alloy able to meet the requirements based on literature assumptions.	R	T0+3M
3	Full characterization of memory shape alloy behavior Following selection of the suitable memory shape alloy in Task 1, Task 3 aims at fully characterizing the thermo-physical properties of this memory shape alloy. These properties are necessary inputs for the complete system design in Task 5 and Task 6.	D	T0+6M
4	Full characterization of heat pipe behavior Following selection of the suitable Heat Pipe technology in Task 2, Task 4 aims at fully characterizing the thermo-physical properties of this Heat Pipe. These properties are necessary inputs for the complete system design in Task 5 and Task 6.	D	T0+6M
5	Implementation and validation of passive actuated inlet model In order to design the system based on more detailed assumptions, a model of the complete system should be developed. The model should be based on the memory shape alloy and heat pipe technology studied in Task 3 and Task 4 but should also be fully adaptable to other configurations. The model will allow the design of the ground and flight demonstrators and should be validated along the project using available tests data.	D	T0+8M
6	Prototype design and manufacturing Based on environmental and physical conditions provided by the Topic Manager and the model created in Task 5, a ground demonstrator of the system should be designed and manufactured in order to test it in Task 7.	HW	T0+11M
7	Prototype test and validation in representative environment A test bench shall be assembled to measure and characterize preliminary performance of the system. The targeted environment being only achievable with a real engine demonstration, a degraded demonstration is targeted here. The obtained tests data should then be used to calibrate the model design in Task 5.	D	T0+14M

Deliverables			
Ref. No.	Title - Description	Type*	Due Date
8	<p>Ground / flight demonstrator design, manufacturing and integration</p> <p>From the validated model obtained in Task 5 and Task 7, and on the physical and environmental conditions provided by the Topic Manager, a ground / flight demonstrator of the system should be designed manufactured and integrated together with the Topic Manager in order to test it in Task 9.</p>	HW	T0+20M
9	<p>Ground / Flight demonstrator test and validation</p> <p>Finally, in order to test and validate the selected design, a ground / flight tests campaign should be achieved in order to validate the design in real conditions.</p>	D	T0+27M

Milestones (when appropriate)			
Ref. No.	Title - Description	Type*	Due Date
1	Technologies selection and characterization	D	T0+6M
2	Prototype design, test and validation	HW	T0+14M
3	Final design, test and validation	HW	T0+27M

4. Special skills, Capabilities, Certification expected from the Applicant(s)

Essential:

- Shape Memory Alloy knowledge, modeling and manufacturing
- Heat Pipes knowledge, modeling and manufacturing
- Mechanical design and integration

Advantageous:

- Integrated tests set-up & validation
- Knowledge in system integration on aircraft nacelle

5. Abbreviations

BPR	By-Pass Ratio
FPR	Fan Pressure Ratio
SMA	Shape Memory Alloy

IX. JTI-CS2-2020-CfP11-LPA-01-96: Analytical and experimental characterization of aerodynamic and aeroacoustic effects of closely operating propellers for distributed propulsion wing solutions

Type of action (RIA/IA/CSA):		RIA	
Programme Area:		LPA	
(CS2 JTP 2015) WP Ref.:		WP 1.6	
Indicative Funding Topic Value (in k€):		2500	
Topic Leader:	Airbus Defence and Space	Type of Agreement:	Implementation Agreement
Duration of the action (in Months):	30	Indicative Start Date (at the earliest)²⁴:	> Q4 2020

Topic Identification Code	Title
JTI-CS2-2020-CfP11-LPA-01-96	Analytical and experimental characterization of aerodynamic and aeroacoustic effects of closely operating propellers for distributed propulsion wing solutions
Short description	
This topic is issued to develop and improve current know-how and design capabilities in the field of distributed propulsion applied to large A/C. The purpose of the topic is the analytical and experimental characterization of the flow interactions of closely operating propellers arranged in different ways on the wing, in order to improve and validate the CFD / CAA design capabilities and know-how within WP 1.6 of CS2-LPA. This topic is meant to develop the necessary physical understanding to progress in the design and assessment of new disruptive concepts with reduced emissions & noise, paving the way for future European initiatives.	

Links to the Clean Sky 2 Programme High-level Objectives ²⁵				
This topic is located in the demonstration area:		Enabling Technologies		
The outcome of the project will mainly contribute to the following conceptual aircraft/air transport type as presented in the scene setter:		Advanced Long-range Ultra-advanced Long-range Advanced Short/Medium-range Ultra-advanced Short/Medium-range		
With expected impacts related to the Programme high-level objectives:				
Reducing CO₂ emissions	Reducing NO_x emissions	Reducing Noise emissions	Improving EU Competitiveness	Improving Mobility
<input checked="" type="checkbox"/>	<input type="checkbox"/>	<input type="checkbox"/>	<input type="checkbox"/>	<input type="checkbox"/>

²⁴ The start date corresponds to actual start date with all legal documents in place.

²⁵ For further info see Chapter 1 "Introduction to the Programme Scene Setter / Objectives" with key technology themes / demonstration areas. Detailed information available in the CS2 Development Plan accessible via the Clean Sky JU Website and EC Participant Portal.

1. Background

Distributed propulsion has become one of the key topics in disruptive A/C design in recent years, growing in parallel to the opportunities that arise from more electric A/C designs, the improvement of hybrid solutions and aiming at future Zero Emissions solutions. In recent times or in the near future several solutions have been / will be flight tested, although at small A/C scale or drone demonstration, such as the Lilium Jet, the Airbus Vahana or the NASA X57, among others.

European A/C manufacturers and research institutions have to pave the road for future designs of large transport solutions starting by ensuring the availability of the necessary design tools and know-how to live up to this new scenario. To this end the availability of high quality and quantity test information becomes necessary, as well as guidelines on the adequate simulation of effects with existing CFD tools. Along the same lines reduced noise design and adequate noise prediction capabilities become essential to ensure the viability of future distributed propulsion solutions, noise being one of the most critical emissions that currently concern the European Authorities. The WTT shall therefore also provide acoustic measurement data and establish the main interaction effects that may affect current noise and/or unsteady pressure simulation capabilities.

The activities under this topic will support the development and assessment of new wing concepts and configurations that benefit from disruptive designs based on distributed propulsion solutions.

The main objective is to develop analytical and experimental evidence to foster computational capabilities and know-how in the field of aerodynamic and aeroacoustic design of distributed propulsion solutions and propeller arrays.

In particular the objective is to be able to predict and validate with the highest possible fidelity the effect of closely operating propellers on the overall wing aerodynamics (such as puller or pusher leading edge or over-wing propeller array configurations) analyzing the effects of the different geometric parameters of interest, like propeller size, relative position among them and with respect to the wing, etc...

The study should also address the experimental characterization of the impact on noise of the different geometric solutions, in order to allow generating design know-how in the field of aeroacoustics and vibrations (unsteady pressures in general) of disruptive configurations.

2. Scope of work

The purpose of the topic is to study different geometries which have been identified as being promising for future novel aircraft configuration powered with hybrid propulsion. The geometries are wing sections equipped with propeller arrays (so called 2.5D wing sections). These geometries will be parametrized, to allow the evaluation of the effect of the most relevant configuration variables on the results. The geometries may include high lift devices / movables. The propeller will have to be assessed in co- and counter-rotating conditions.

Tentative examples of the geometries to be proposed can be found in figure 1. More specifically:

- Geometry 1 (a) is a blown leading edge straight wing for operation at low subsonic cruise ($M=0.4$), with powerful retractable flap system. This geometry tries to combine high lift capability with good cruise performance. One of the topics of interest is the interaction of power effects with (double) slotted flaps.
- Geometry 1 (b) is the most disruptive one, trying to boost low speed operations & STOL capabilities. In cruise this configuration is not expected to be the best one, but the overall trade-off is deemed advantageous. This configuration would be a real game-changer in civil operation in remote areas.

- Geometry 1 (c) is focused on cruise at higher speed ($M > 0.55$). It includes wing sweep, which brings in another topic of interest, which is the evaluation of engine pitch and its effect on close operating propeller interaction.

All three models will have to be modular (at least) in:

- Distance between engines
- Position of the propeller plane wrt wing
 - Distance to LE
 - Strut height
- High-lift devices / movables
- Rotation of the propellers (co-counter-rotating)
- Any other parameter that shows significant relevance during the initial CFD analyses

The TM commits to providing reasonable/acceptable ranges for each of these parameters in due time.

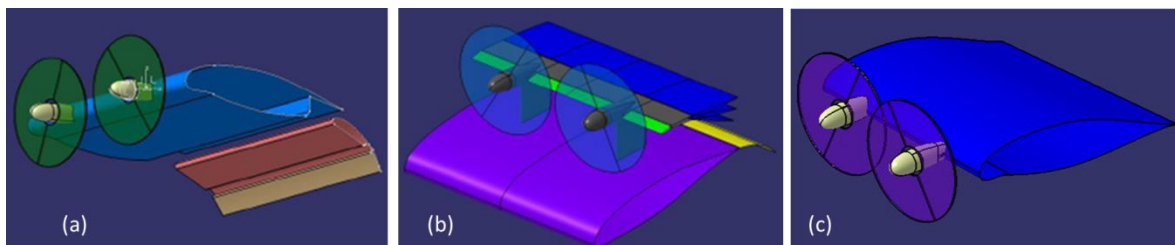

Figure 1: Tentative configurations.

The applicant (s) will have to design and or select of-the-shelf propellers suitable for the intended design points. Please note that evaluating the effect of co and counter rotation is of highest priority, implying the availability of the corresponding propeller sets.

A single common propeller design with balanced behavior for all three sections & and design points may do, especially if propeller pitch is adjustable. Another viable option, especially if fast prototyping capabilities are available (e.g. 3D printing), is to design/select specific solutions for each concept. In any case, propeller diameter and solidity will be similar. TM will support propeller selection/design. In any case, optimized propeller design for each of the configurations is NOT the target of this call, only a representative air flow over the sections has to be ensured.

The applicant(s) will then perform a numerical aerodynamic characterization of the proposed wing sections equipped with the propeller designed. The idea is to compare this characterization (including flow behavior and interactions) against WTT data. The most relevant aerodynamic parameters have to be identified and pondered, either proposing feasible optimal values for testing or specifying a parameter variation range for the test models in order to fully characterize the effect.

The applicant(s), after discussing its methods and results with the TM, will perform an experimental validation of the calculations. To this end the TM proposes a build-up approach, with increasing fidelity and technical difficulty.

In a first phase the applicant(s) will characterize the set of proposed geometries making use of low speed - medium sized WTT facilities (e.g. University/Research Center facilities), providing data in terms of: pressure distribution, aerodynamic efficiencies (L/D), max lift and flow field visualization. The idea is that in a first round the characterization in such facilities of these geometries and related geometrical

parameters will provide sufficiently good data and know-how to consolidate the next step of analysis and validation at a reasonable cost. At this stage no aeroacoustic analysis or test validation is considered.

Please consider that these test facilities shall allow testing at speeds above 25m/s. Test specimens shall be relatively large, with scaling factors not smaller than $\frac{1}{4}$, i.e. overall model span of approximately 1 meter.

The activities of the first phase could be summarized as follows:

- Propose propeller design based on conditions provided by TM.
- Perform initial CFD simulation, generating initial database.
- Design & manufacture the WT models, including propellers and electric engines providing a representative propulsion simulation. The WT models should be of variable geometry in line with the parameters to be evaluated (e.g. propeller relative positions and position wrt the wing, high lift devices, etc...).
- Prepare the necessary propeller control system for wind tunnel testing.
- Test the models in WT at different airspeeds & propeller settings,
 - o Producing the necessary lift/drag polars
 - o Visualizing/measuring flow and pressure distribution variations.
- Perform an assessment of the CFD vs WT results, in order to validate the capability of the CFD models to predict interaction effects, defining the best methodology to be applied.
- Together with the TM define the most interesting configuration(s) for the next testing phase.

In a second phase, TM & applicant(s) will define up to two different wing section concepts (again 2.5D) with a consolidated geometry and propeller arrangement based on the analysis and data generated in the first phase. The applicant(s) will have to analyze, design and manufacture the WT models targeting the highest possible fidelity characterization of the configuration in terms of aerodynamic and aeroacoustic behavior, assessing on the principal parameters affecting the results.

These tests shall be performed with tests speeds in the range of 50m/s to 100m/s. For reference, the full scale aircraft sections have a chord in the range of 2 to 3m and a span of approximately 4 to 5m, leading to Re numbers in the range of 10 to 20 million ($Re \sim [10 \cdot 10^6 \text{ to } 20 \cdot 10^6]$) at SL.

The activities could be summarized as follows:

- Prepare the geometries, these being result of the previous phase (incl. previous propeller design).
- Perform initial CFD and CAA simulation, generating initial databases.
- Manufacture the WT models, including propellers and electric engines providing a representative propulsion simulation. The WT models may be of variable geometry (e.g. propeller relative positions and position wrt the wing, high lift devices, etc...).
- Prepare the necessary propeller control system for wind tunnel testing
- Test the models in WT at different airspeeds & propeller settings,
 - o Producing the necessary lift/drag polars
 - o Visualizing/measuring flow and pressure distribution variations
 - o Measuring noise and possibly vibration levels
- Perform an assessment of the CFD vs WT results, in order to validate the capability of the CFD models to predict interaction effects, defining the best methodology to be applied. I.e. review and consolidate the outcomes of the first testing phase.

- Perform an assessment of the Computational Aero-Acoustic results vs WT results, in order to validate the capability of the CAA models to predict interaction effects, defining the best methodology to be applied.

Finally assess the extrapolation of the results to full 3D geometries agreed between TM and the applicant(s), evaluating on the scalability of the results.

3. Major Deliverables/ Milestones and schedule (estimate)

Scope of this topic is two years and half with an effective start date in Q4/2020 (project kick-off, with Implementation Agreement in place), with a duration of 30 months.

List of Milestones		
Ref. No.	Title – Description	Due Date
M1	Models definition and geometry / conditions exchange with TM	M1
M2	Models design: Identification of most relevant parameters & parametrization	M2
M3	Test strategy for phase 1 established	M2
M4	Propeller selected / designed for all configurations	M5
M5	Models and test means design & manufacturing plan – phase 1	M5
M6	Models-Phase 1 Aerodynamic CFD characterization	M9
M7	Models manufactured and verified	M9
M8	Test completion – phase 1	M15
M9	Benchmarking WTT & CFD - Assessment on CFD Down-selection of configurations for Phase 2.	M18
M10	Test strategy for phase 2 established	M19
M11	Models and test means design & manufacturing plan – phase 2	M19
M12	Models - Phase2 Aerodynamic & Aeroacoustic CFD characterization	M22
M13	Models manufactured and verified	M22
M14	Test completion – phase 2	M27
M15	Benchmarking WTT & CFD / Aeroacoustics	M30
M16	Final assessment and lessons learned	M30

List of deliverables		
Ref. No.	Title – Description	Due Date
D1	Model parametrization & Test strategy phase 1 (including test window consolidation)	M2
D2	Propeller selection / design & Model & test means design	M5
D3	Models CFD characterization data & results analysis phase 1	M9
D4	Model manufacturing & validation report phase 1	M9
D5	Phase 1 tests report & data	M15
D6	Report on WTT vs CFD results - assessment on findings.	M18
D7	Test strategy phase 2 (including test window consolidation) Model & test mean design	M19
D8	Models CFD characterization data & results analysis phase 2	M22
D9	Model manufacturing & validation report phase 2	M22
D10	Phase 2 tests report & data	M27

List of deliverables		
Ref. No.	Title – Description	Due Date
D11	Report on WTT vs CFD results - assessment on findings. Assessment of results scalability to 3D wing geometry.	M30
D12	Final project wrap up report	M30

4. Special skills, Capabilities, Certification expected from the Applicant(s)

Essential:

- CFD and CAA analysis experience and capabilities, to setup initial databases.
- Model design experience and capabilities, including CFD and CAA design and power-plant sizing and tuning, including propeller preliminary design.
- Model manufacturing experience and capabilities, including power-plant control.
- Demonstrated wind tunnel test experience
- Demonstrated experience in Aero-Acoustic wind tunnel testing
- Access to top level wind tunnel facilities in Europe, although testing capability at proprietary research/education facilities for model development is an add-on.

Advantageous:

- Use of standard industrial CFD/CAA codes, such as TAU, Flow Sim, Ansys Fluent or CFX, PowerFlow, ...
- Use of design tools, such as CATIA
- Fast prototyping capabilities (e.g. 3D printing for propellers)

5. Abbreviations

ADS	Airbus Defence and Space
CAA	Computational AeroAcoustics
CFD	Computational Fluid Dynamics
CFP	Call For Proposal
KO	Kick Off
L/D	Lift over Drag
LPA	Large Passenger Aircraft
SL	Sea Level
TM	Topic Manager
WP	Work Package
WTT	Wind Tunnel Test

X. JTI-CS2-2020-CfP11-LPA-01-97: Insulation Monitoring for IT Grounded (Isolation Terra) Aerospace Electrical Systems

Type of action (RIA/IA/CSA):		IA	
Programme Area:		LPA	
(CS2 JTP 2015) WP Ref.:		WP 1.6.1	
Indicative Funding Topic Value (in k€):		700	
Topic Leader:	Rolls-Royce plc	Type of Agreement:	Implementation Agreement
Duration of the action (in Months):	24	Indicative Start Date (at the earliest)²⁶:	> Q4 2020

Topic Identification Code	Title
JTI-CS2-2020-CfP11-LPA-01-97	Insulation Monitoring for IT Grounded (Isolation Terra) Aerospace Electrical Systems
Short description	
<p>With an increase in the predicted demand for high voltage electrical power in large passenger aircraft and other more electric aircraft concepts, new electrical distribution systems will be required to enable safe, light, highly efficient electrical propulsion systems. Insulation monitoring technology is a crucial safety system on high integrity power distribution in land and marine systems, however they have not been tested, proven, optimised and made commercially available for aerospace. A functionally representative insulation monitoring demonstration for aerospace is required, incorporating applicable lessons and experience of established markets, but addressing some of the specialised aerospace environment and its safety processes.</p>	

Links to the Clean Sky 2 Programme High-level Objectives²⁷				
This topic is located in the demonstration area:		Electrical Systems		
The outcome of the project will mainly contribute to the following conceptual aircraft/air transport type as presented in the scene setter:		Ultra-advanced Long-range Ultra-advanced Short/Medium-range		
With expected impacts related to the Programme high-level objectives:				
Reducing CO₂ emissions	Reducing NO_x emissions	Reducing Noise emissions	Improving EU Competitiveness	Improving Mobility
☒	☒	☒	☒	☒

²⁶ The start date corresponds to actual start date with all legal documents in place.

²⁷ For further info see Chapter 1 “Introduction to the Programme Scene Setter / Objectives” with key technology themes / demonstration areas. Detailed information available in the CS2 Development Plan accessible via the Clean Sky JU Website and EC Participant Portal.

1. Background

Current Large Passenger Aircraft (LPA) use low voltage (below 1kVac rms or 1.5kVdc) distribution systems to transmit a relatively modest amount of power (below 1MW) for use in aircraft subsystems such as cabin conditioning and actuation. The existing power distribution systems often use the metallic airframe as the earthing system.

Electric propulsion systems have the potential to make a significant impact on LPA emissions, facilitating CO₂, NO_x and noise reductions. However to make electric or hybrid propulsion systems feasible, greater electrical power transmission at high voltage will be required. High power electrical systems in high reliability applications often utilise IT earthing (Isolation Terra). IT earthing brings known advantages of fault current management and continued operation post fault. It also brings the challenge of correctly determining when an insulation fault has occurred, allowing the system to safely reconfigure or shutdown.

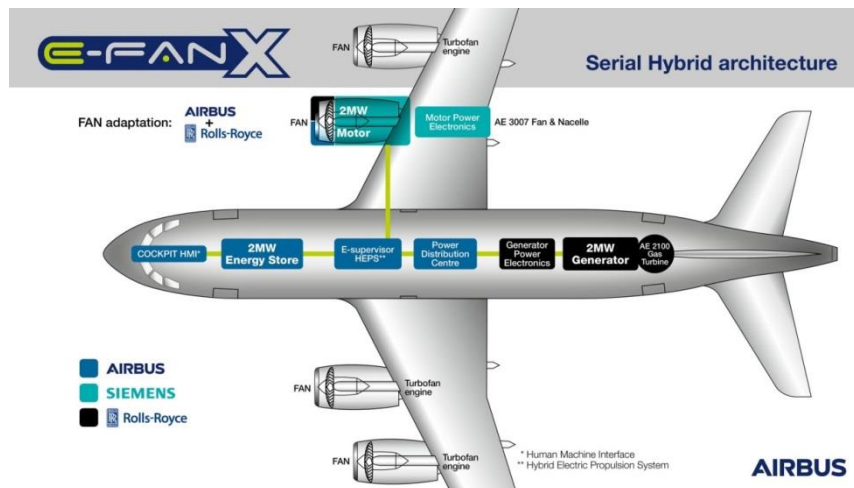

There are currently no large electric or hybrid aerospace power systems in operation, therefore no aerospace insulation monitoring system demonstrators available. Demonstrators, such as E-Fan X (see above Figure) and EcoPulse, are planned by numerous European aerospace companies and while all are likely to require insulation monitoring as a system enabler, few aerospace companies have significant experience with creating insulation monitoring systems.

The lessons and experience of established markets, such as stationary power grids, maritime vessels, solar power, traction systems and other modes of electric mobility can be brought to bear to speed development, while tailoring the packaging and functionality to the specialised aerospace environment and its safety processes.

Aerospace offers a hostile environment for electrical equipment with frequent extreme temperature and pressure cycling from approximately 55°C at 1atm to -55°C at 0.2atm for every flight; along with difficulties common to other applications such as high vibration, contamination, humidity and condensation. Electrically the installation is functionally similar to those seen on industrial and transport applications, but with stringent safety and reliability challenges, especially when used for electric propulsion. Safety critical architectures may push reliability requirements to a rate of 1e-9.

The simple objective of the Work Package is to make available a functionally representative insulation monitoring demonstration for aerospace applications, incorporating applicable lessons and experience

of established markets, but considering the specialised aerospace environment and its safety processes.

This strategic theme falls under the umbrella of Clean Sky 2 Platform 1 work package (WP) 1.6.1 – Alternative Energy Propulsion Architecture & Components within the Clean Sky 2 Large Passenger Aircraft (LPA).

The Work Breakdown Structure (WBS) will include three Work Packages (WP's) as below:

- WP1: Analysis of applicable systems to obtain requirements and targets for development.
- WP2: Modelling and development of aerospace applicable technologies.
- WP3: Demonstration and testing.

2. Scope of work

Requirements:

An insulation monitoring demonstration shall be developed up to TRL4.

The system shall be suitable for use on high voltage distribution systems, over 1000Vac rms and 1500Vdc.

The system shall be suitable for demonstration on systems of MW scale.

The system should be suitable for use on systems with representative capacitance to earth, to be discussed with the Topic Manager.

The demonstration is not required to operate in representative environmental conditions, but should show a development route to representative environment testing aided by the Topic Manager.

Tasks		
Ref. No.	Title – Description	Due Date
1.1	Aerospace environment and system – The environment and system characteristics pertinent to insulation monitoring need to be understood and documented to ensure the system can be easily integrated.	T0 + 1
1.2	Performance and operational requirements – Capture the requirements from the Topic Manager, making sure the systems performance will be adequate.	T0 + 3
1.3	Gap analysis – A comparison between current available state of the art insulation monitoring systems and aerospace requirements, including certification to direct development work.	T0 + 5
2.1	System model – Modelling of typical system including monitoring device to benchmark the development of new technology both simulated hardware and software.	T0 + 9
2.2	Technology development – Develop insulation monitoring technology and enabling systems to bridge gaps defined earlier in project with consideration of specific aerospace requirements.	T0 + 17
3.1	Prototype – Prototype unit production, or prototype components/software as required for demonstration of capability.	T0 + 19

Tasks		
Ref. No.	Title – Description	Due Date
3.2	Testing and validation – Against the requirements from the Topic Manager and system assessments. <i>Set out the development rout to achieve environmental condition testing, such as altitude and temperature – to be discussed with the Topic Manager as they will depend on installation location.</i>	T0 + 22
3.3	Customer verification – Reviewing and trialling monitoring systems with the Topic Manager.	T0 + 23

3. Major Deliverables/ Milestones and schedule (estimate)

*Type: R=Report, D=Data, HW=Hardware

Deliverables			
Ref. No.	Title – Description	Type*	Due Date
D1.3	Summary of research requirements and gap analysis.	R	T0 + 5
D2.1	Summary of technology developments and future roadmap.	R	T0 + 17
D3.1	Verification of proposed product with the Topic Manager.	R	T0 + 23

Milestones (when appropriate)			
Ref. No.	Title – Description	Type*	Due Date
M1.3	Research requirements and gap analysis completed.	D	T0 + 5
M2.1	Summary of technology developments and future roadmap.	R	T0 + 17
M3.3	Verification of proposed product with the Topic Manager.	R	T0 + 23

4. Special skills, Capabilities, Certification expected from the Applicant(s)

Essential:

- Substantial experience and understanding of standard insulation monitoring system implementations – there is no desire for the aerospace supply chain to reinvent insulation monitoring. There are highly effective systems that can provide solid grounding for aerospace specific systems.
- Ability to produce demonstration insulation monitoring hardware – this project aims to get working hardware available for electrically representative demonstration at TRL4, to do this prototyping facilities are necessary.
- Aerospace production route – investment and capability growth or future development partnerships may be required to demonstrate a route to an aerospace standard product, the applicant will need to support this.

5. Abbreviations

IT	Isolation Terra
TRL	Technology Readiness Level
LPA	Large Passenger Aircraft
rms	Root Mean Square

XI. JTI-CS2-2020-CfP11-LPA-02-33: Tooling, Equipment and Auxiliaries for the closure of a longitudinal Barrel Joint: Butt strap integration and Lightning Strike Protection continuity

Type of action (RIA/IA/CSA):		IA	
Programme Area:		LPA	
(CS2 JTP 2015) WP Ref.:		WP 2.1	
Indicative Funding Topic Value (in k€):		1600	
Topic Leader:	Airbus	Type of Agreement:	Implementation Agreement
Duration of the action (in Months):	30	Indicative Start Date (at the earliest)²⁸:	> Q4 2020

Topic Identification Code	Title
JTI-CS2-2020-CfP11-LPA-02-33	Tooling, Equipment and Auxiliaries for the closure of a longitudinal Barrel Joint: Butt strap integration and Lightning Strike Protection continuity
Short description	
One or more conduction welding heads, auxiliary equipment and consumables for the closure of an 8m typical fuselage barrel utilizing a butt strap need to be designed, manufactured, supplied and serviced on-site for this topic. Furthermore, following barrel closure, results need to be analysed and additional functionalities regarding improved in-situ monitoring and control integrated into the welding head or heads.	

Links to the Clean Sky 2 Programme High-level Objectives²⁹				
This topic is located in the demonstration area:		Cabin & Fuselage		
The outcome of the project will mainly contribute to the following conceptual aircraft/air transport type as presented in the scene setter:		Advanced long range Advanced Short/Medium-range		
With expected impacts related to the Programme high-level objectives:				
Reducing CO₂ emissions	Reducing NO_x emissions	Reducing Noise emissions	Improving EU Competitiveness	Improving Mobility
<input checked="" type="checkbox"/>	<input checked="" type="checkbox"/>	<input type="checkbox"/>	<input checked="" type="checkbox"/>	<input type="checkbox"/>

²⁸ The start date corresponds to actual start date with all legal documents in place.

²⁹ For further info see Chapter 1 "Introduction to the Programme Scene Setter / Objectives" with key technology themes / demonstration areas. Detailed information available in the CS2 Development Plan accessible via the Clean Sky JU Website and Funding and Tenders Portal.

1. Background

Technical Challenge

The WP2.1 Integrated Fuselage has ambitious targets in reducing the fuselage weight, reducing its costs and production leadtime while enabling a high production rate of minimum 75+ aircrafts per month and improving its manufacturing flexibility.

In the frame of WP2.1, the Multi-Functional Fuselage Demonstrator (Figure 1) seeks to validate high potential combinations of airframe structures, cabin, cargo and system elements using composite thermoplastics, innovative design principles and advanced system architecture in combination with the next generation cabin, through a large-scale complex demonstration at full size.

This topic will contribute to WP2.1 by tackling one of the most critical and important aspects of this demonstration that is the realization of barrel closure in a representative Main Component Assembly environment. This topic addresses the closure of the Butt strap joint and Lightning Strike Protection continuity.

The objective of this topic is the provision of tooling heads, on-site support and all required operational information for the closure of a longitudinal barrel joint of a pre-equipped aircraft fuselage demonstrator from thermoplastic structural material.

Prototype tooling heads need to be delivered early on in the project to the existing Main Component Assembly. Further development is focussed on industrial maturation with a particular focus on in-situ monitoring and control.

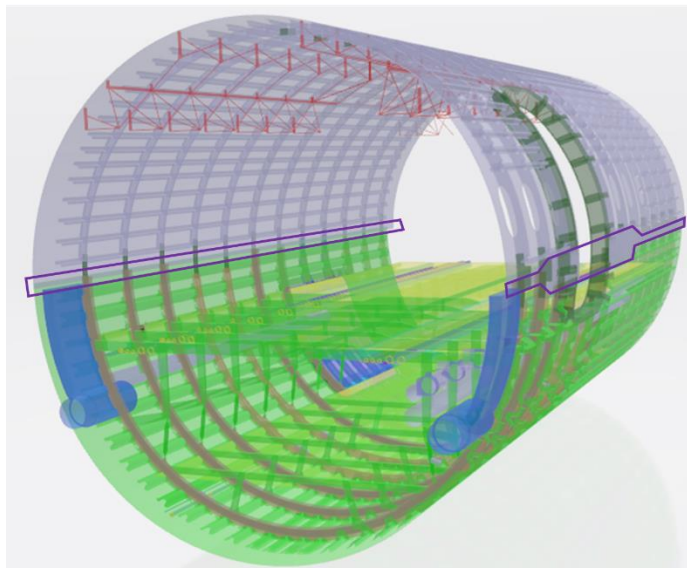

Figure 1: Illustration of the intermediate overall demonstrator design with the longitudinal joints highlighted (purple)

Two main challenges are presented in this topic:

- Butt strap joint (Figure 3):
 - The demonstrators' left hand side includes the Passenger Door Surround. The skin thickness variation in this area necessitates a stepped butt strap integration, joining Upper and Lower skins.
 - Given the joint complexity, conduction welding using a heated pressure plate is the

preferred joining technology.

- Electrical Continuity of the Lightning Strike Protection (Figure 4):
 - Electrical continuity of the metallic Lightning Strike Protection (LSP) must be achieved across both longitudinal joints on the outside of the fuselage.
 - It is expected that the tooling head provided for the butt strap integration may be used for this purpose.

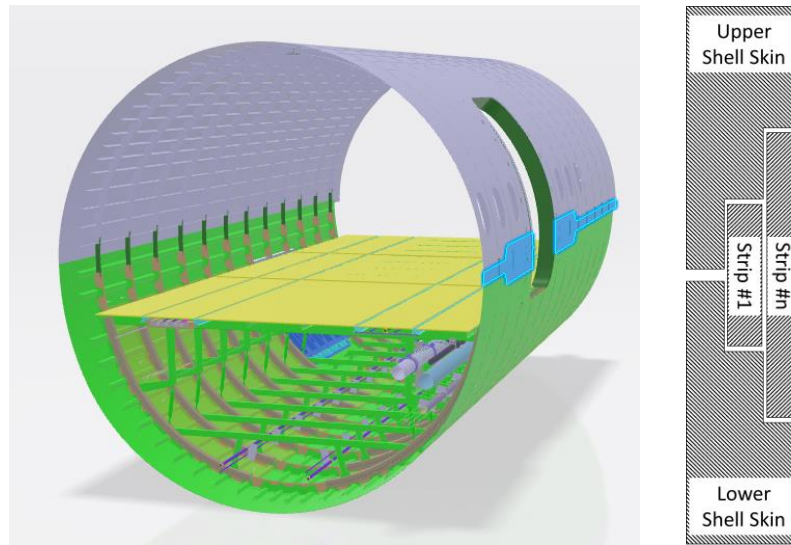

Figure 3: Butt strap integration: A number of overlying strips require integration across the stepped joint. Note that the Butt strap sits on the outside of the fuselage.

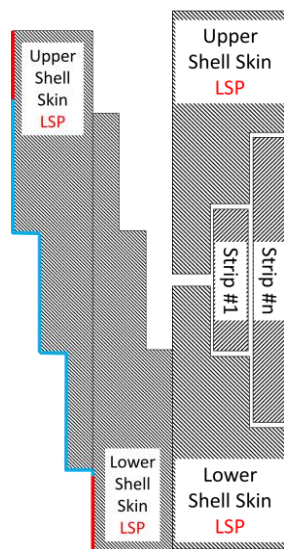

Figure 4: A CFRP fuselage requires protection from lightning strike. Therefore, Upper and Lower Shell skins are equipped with a metallic Lightning Strike Protection. Electrical continuity must be achieved across the longitudinal joints on the outside of the fuselage. Left: Overlap Joint. Right: Butt Strap joint. Red indicates pre-equipped Lightning Strike protection, blue indicates Lightning Strike Protection to be applied as part of this topic.

Work Package Breakdown Structure

In order to achieve the different technical and technological challenges defined in the demonstrator, the Work Package Breakdown Structure and activity scope matrix shown in Figure 6 is recommended.

In this manner, each of the primary Work Packages (WP) addresses one of the Top Level Objectives (TLO) of this topic.

These are:

- Achievement of a high quality, stepped butt strap integration connecting the upper and lower fuselage skins
- Achievement of the electrical coupling of the upper and lower fuselage skins Lightning Strike Protection.

Furthermore, underlying developments and activities need to be conducted to enable the successful achievement of these TLO's. While the majority of of these are described in more detail within Chapter **Error! Reference source not found. Error! Reference source not found.**, special note should be made of the need to supply auxiliary structures and materials, such as counterholders, or safety relevant provisions and equipment. Depending on the technological variants chosen, a dedicated WP for this may be beneficial.

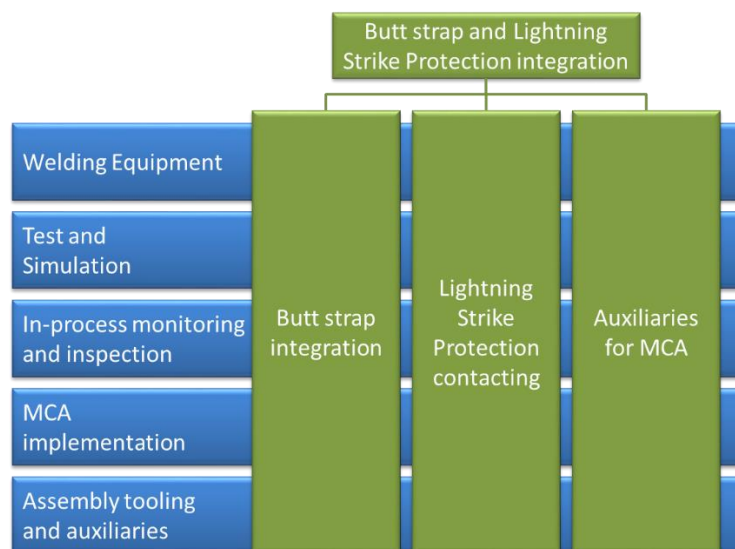

Figure 6: Work Package Breakdown Structure and key activity matrix

Project environment

The project addresses some of the most important interfaces with respect to the CleanSky 2 Large Passenger Aircrafts Multifunctional Fuselage. As such, the project may be led through WP2.1.3 Integrated concepts definition and maturation, but it requires a very open exchange between partners delivering the Lower and Upper Shell structures, the Main Component Assembly partnership (WP2.1.6), welding technology developers and associated project consortia. Furthermore, cooperation with the complementary project responsible for the tooling development and supply for the overlap joint is essential.

An overview of the current WBS of the Multifunctional Fuselage is given in Figure 7.

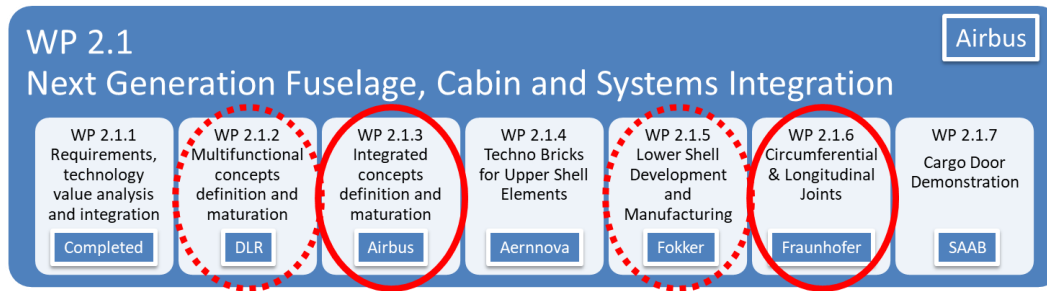

Figure 7: Next Generation Fuselage, Cabin and Systems Integration. Led through WP2.1.3 “Integrated concepts definition and maturation” a strong link to WP2.1.6 is required to WP2.1.6 Circumferential & Longitudinal Joints. In addition, close cooperation is expected in particular with WP2.1.2 and 2.1.5 where important welding developments are taking place.

2. Scope of work

Tasks		
Ref. No.	Title - Description	Due Date
TX.1	Requirements analysis and Functional Breakdown	T+1M
TX.2	Tooling Specific Design	T+6M
TX.3	Test pieces for Main Component Assembly integration	T+11M
TX.3	Tooling manufacturing and delivery	T+11M
TX.4	On-site support	T+17M
TX.5	Process performance verification and analysis	T+18M
TX.6	Improved functionality implementation and verification on welding equipment	T+27M
TX.7	Documentation and Dissemination	T+28M
TX.8	Technological de-risking trials and simulation	T+30M

Each of the Work Packages needs to conduct a number of tasks in order to fulfill the objectives of the topic:

Requirements analysis and Functional Breakdown

At the start of the project, the selected applicant shall receive the Requirements and Specification document as well as background information stemming from preparatory work conducted by the WP2.1 consortium. The applicant needs to analyse and further break-down these needs into tooling relevant requirements and functionalities. The outcomes of this activity will then serve as the main guiding principles for the specific tooling design phase. Particular emphasis will be placed on Health and Safety, Performance and Monitoring thereof.

Tooling Specific Design

The tacted Tooling Specific Design shall be characterized by regular exchanges between the lead tooling designers of the applicant in order to ensure compatibility, allow an early familiarization of users with the equipment and prioritize functionality integration.

Tooling manufacturing and delivery

At the end of this activity, the required tooling heads, test pieces, auxiliary structures and equipment shall have been supplied. A staggered delivery schedule is preferred over a single bulk delivery to facilitate project conduct and MCA integration. Specifically, tooling for the Butt strap integration is required in Month 11. This includes delivery of the first integration test pieces for on-site trials.

Consumables and parts for the barrel demonstrator, such as the butt strap strips with are required in month 13. At this point, any special provisions required to perform the cross-joint LSP contacting are also required.

On-site support

The project shall provide on-site support and be responsible for the succesfull implementation of the tooling and equipment in the MCA. This covers both the initial tooling integration as well as the performance of the joining operation itself.

Process performance verification and analysis

Running throughout the course of the project, this activity first verifies critical process parameters and tooling functionalities. It therefore focuses first on fundamental experimental and simulative studies regarding the principal process parameters before moving on to take special consideration of inspection and in-line process control techniques. Besides the applicant own work and results, data from the wider Demonstrator consortium will need to be considered during this development.

Improved functionality implementation and verification on welding equipment

Subsequent to the detailed performance analysis, lessons-learned shall be applied to the tooling design, in particular the end effector(s). These shall be verified, prefferably experimentally within the timeframe of this project. The specific focus lies in the implementation of further in-line process monitoring and control methods with a view to directly feeding into the demonstrators Product Lifecycle Management Digital Twin within 3D Experience.

Documentation and Dissemination

All work packages shall strive to perform in particular scientific publications as well as support the standardization of thermoplastic welding processes when applied to commercial aircraft.

Technological de-risking trials and simulation

Running throughout the duration of the project, this activity encompasses all required testing and simulation activities. As such, it represents a crucial stream of coupon and element level manufacturing and performance trials. While initially this stream will need to focus strongly on the actual joining operation itself, it will transform more towards monitoring, control and industrial integration as the project progresses. The applicant is expected to propose a list of relevant tests at coupon and barrel level.

3. Major Deliverables/ Milestones and schedule (estimate)

**Type: R= Report, RM= Review Meeting, D=Data, HW=HardWare*

Deliverables			
Ref. No.	Title - Description	Type*	Due Date
D1	Tooling Specific Design Requirements Dossier	Report	T+1M
D2	Welding End effector and auxiliaries design	Data	T+7M
D3	Welding Technology: De-risking test and simulation intermediate report	Report	T+10M
D4	Delivery of Welding End effector and auxiliaries	Hardware	T+11M
D5	Delivery of Welding Test pieces for Tooling verification	Hardware	T+11M
D6	Delivery of Butt strap stripes for Barrel closure	Hardware	T+13M
D7	Welding End effectors and auxiliaries integrated in MCA	Hardware	T+13M
D8	On-site support, Quality assurance completed	Report	T+18M
D9	Equipment optimization report	Report	T+28M
D10	Welding Technology: De-risking test and simulation final report	Report	T+29M
D11	Delivery of optimized welding equipment	Hardware	T+29M

Milestones (when appropriate)			
Ref. No.	Title - Description	Type*	Due Date
M1	Kick-off Meeting	Meeting	T0
M2	Intermediate Tooling Review	Review	T+4M
M3	Tooling Specific Design Review	Review	T+7M
M4	Tooling Manufacturing Review and Delivery acceptance	Review	T+11M
M5	Barrel Joining Review: Tooling performance review	Review	T+18M
M6	Functionality optimization progress Review	Review	T+24M
M7	Final Project Meeting	Meeting	T+30M

In order to facilitate planning, the project is displayed within the context of the overall Multifunctional Fuselage in Figure 8.

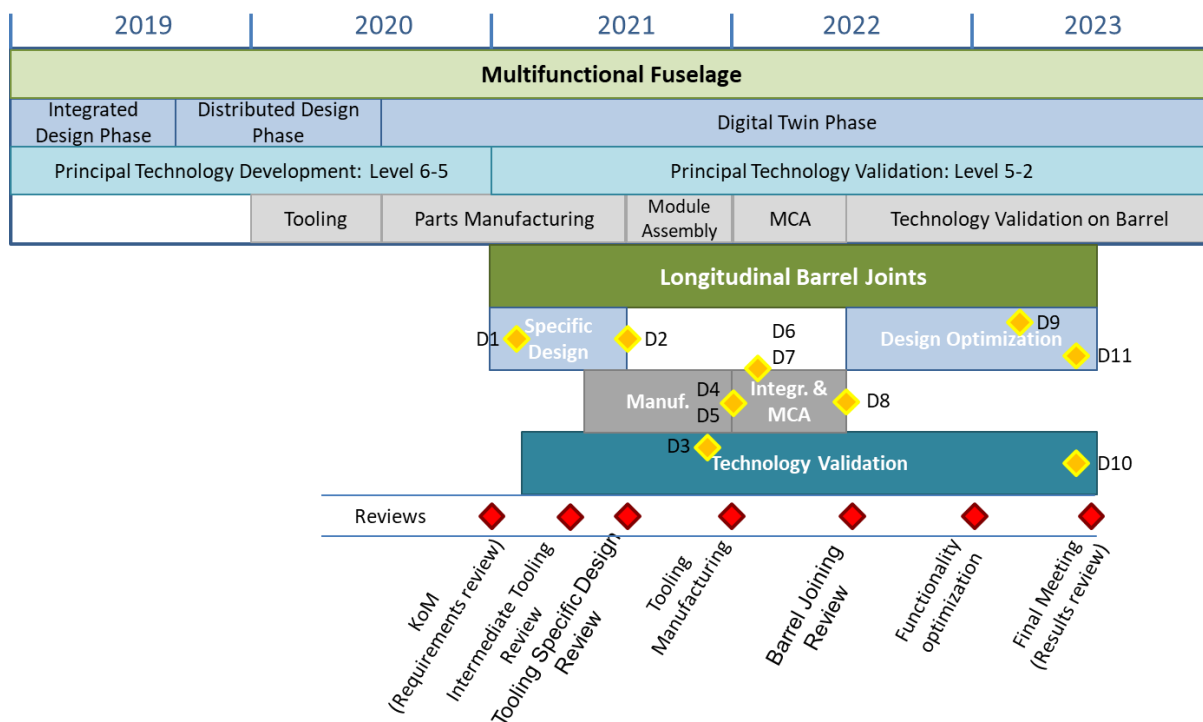

Figure 8: Timeline of the project in relation to the overall Multifunctional Fuselage. Deliverables and Milestones for this project are marked.

4. Special skills, Capabilities, Certification expected from the Applicant(s)

It is expected that the interdisciplinary core competences required for the successful delivery of this project can only be found by a highly competent consortium incorporating industrial and academic partners with proven and recognized core competences.

Essential:

- Skill: In-depth project management in time, cost and quality together with evidence of past



experience in large project participation.

- Skill: Specific machine tool design, manufacture and support to industry proven on a regular and recent basis
- Skill: Proven expertise in the provision of conduction welding equipment for thermoplastics
- Skill: In-depth understanding of thermoplastic materials and welding thereof
- Skill: Online process monitoring and control for Quality Assurance
- Capability: In-house equipment for the chosen welding technologies
- Capability: Implementation of 3D Experience for the conduct of this project

Advantageous:

- Skill: Integrated Way-of-Working within a Product Lifecycle Management environment
- Skill: Manufacturing and Processing validation for large passenger aircraft, in particular for composites
- Skill: Experience with PAEK material family, preferably regarding welding
- Skill: Recognized successful collaborations in the fields of Manufacturing Engineering and Materials and Processes
- Skill: Utilization of 3D Experience in a partner environment

5. Abbreviations

CfP	Call for Proposals
CFRP	Carbon Fibre Reinforced Polymer
LSP	Lightning Strike Protection
MCA	Main Component Assembly
TLO	Top Level Objective
WP	Work Package

XII. JTI-CS2-2020-CfP11-LPA-02-34: Tooling, Equipment and Auxiliaries for the closure of a longitudinal Barrel Joint: Overlap joint and Frame Coupling integration

Type of action (RIA/IA/CSA):		IA	
Programme Area:		LPA	
(CS2 JTP 2015) WP Ref.:		WP 2.1	
Indicative Funding Topic Value (in k€):		1400	
Topic Leader:	Airbus	Type of Agreement:	Implementation Agreement
Duration of the action (in Months):	30	Indicative Start Date (at the earliest)³⁰:	> Q4 2020

Topic Identification Code	Title
JTI-CS2-2020-CfP11-LPA-02-34	Tooling, Equipment and Auxiliaries for the closure of a longitudinal Barrel Joint: Overlap joint and Frame Coupling integration
Short description	
Ultrasonic and resistance welding heads, auxiliary equipment and consumables for the closure of an 8m typical fuselage barrel need to be designed, manufactured, supplied and serviced on-site for this topic. Furthermore, following barrel closure, results need to be analysed and additional functionalities regarding improved in-situ monitoring and control integrated into the welding heads.	

Links to the Clean Sky 2 Programme High-level Objectives³¹				
This topic is located in the demonstration area:		Cabin & Fuselage		
The outcome of the project will mainly contribute to the following conceptual aircraft/air transport type as presented in the scene setter:		Advanced long range Advanced Short/Medium-range		
With expected impacts related to the Programme high-level objectives:				
Reducing CO₂ emissions	Reducing NO_x emissions	Reducing Noise emissions	Improving EU Competitiveness	Improving Mobility
<input checked="" type="checkbox"/>	<input checked="" type="checkbox"/>	<input type="checkbox"/>	<input checked="" type="checkbox"/>	<input type="checkbox"/>

³⁰ The start date corresponds to actual start date with all legal documents in place.

³¹ For further info see Chapter 1 "Introduction to the Programme Scene Setter / Objectives" with key technology themes / demonstration areas. Detailed information available in the CS2 Development Plan accessible via the Clean Sky JU Website and Funding and Tenders Portal.

1. Background

Technical Challenge

The WP2.1 Integrated Fuselage has ambitious targets in reducing the fuselage weight, reducing its costs and production leadtime while enabling a high production rate of minimum 75+ aircrafts per month and improving its manufacturing flexibility.

In the frame of WP2.1, the Multi-Functional Fuselage Demonstrator (Figure 1) seeks to validate high potential combinations of airframe structures, cabin, cargo and system elements using composite thermoplastics, innovative design principles and advanced system architecture in combination with the next generation cabin, through a large-scale complex demonstration at full size.

This topic will contribute to WP2.1 by tackling one of the most critical and important aspects of this demonstration that is the realization of barrel closure in a representative Main Component Assembly environment. This topic addresses the closure of the Butt strap joint and Lightning Strike Protection continuity.

The objective of this topic is the provision of tooling heads, on-site support and all required operational information for the closure of a longitudinal barrel joint of a pre-equipped aircraft fuselage demonstrator from thermoplastic structural material.

Prototype tooling heads need to be delivered early on in the project to the existing Main Component Assembly. Further development is focussed on industrial maturation with a particular focus on in-situ monitoring and control.

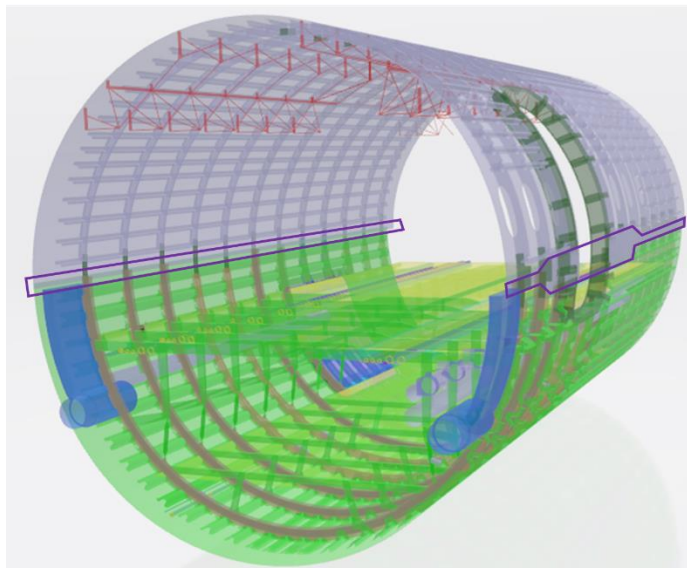

Figure 1: Illustration of the intermediate overall demonstrator design with the longitudinal joints highlighted (purple)

Two main challenges are presented in this topic:

- **Overlap joint (Figure 2):**
 - The 8m long overlap joint on the demonstrators' right hand side (in flight direction) connects the Upper and Lower Fuselage skins. In a longitudinal direction, skin thickness below 3mm is constant in the welding zone. In the circumferential direction, skin's feature a stepped geometry for improved structural performance.
 - Ultrasonic welding is the preferred joining in order to achieve high production rate.

- Frame coupling integration (Figure 5):
 - Overlap joint: Frame couplings beneath the overlap joint need to structurally bond the Upper and the Lower Shell frames.
 - Butt strap: Frame couplings beneath the Butt strap need to structurally bond the Upper and the Lower Shell frames as well as connect to the skin.
 - Resistance welding is the preferred technology for this technical challenge.

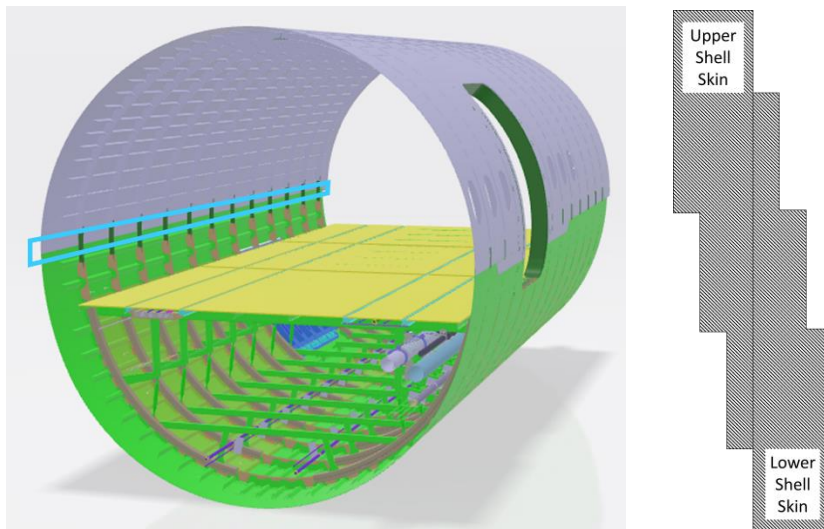

Figure 2: Overlap joint: A stepped approach has been taken in the overlap joint design. Note that the Lower Shell lies on the inner side of the fuselage.

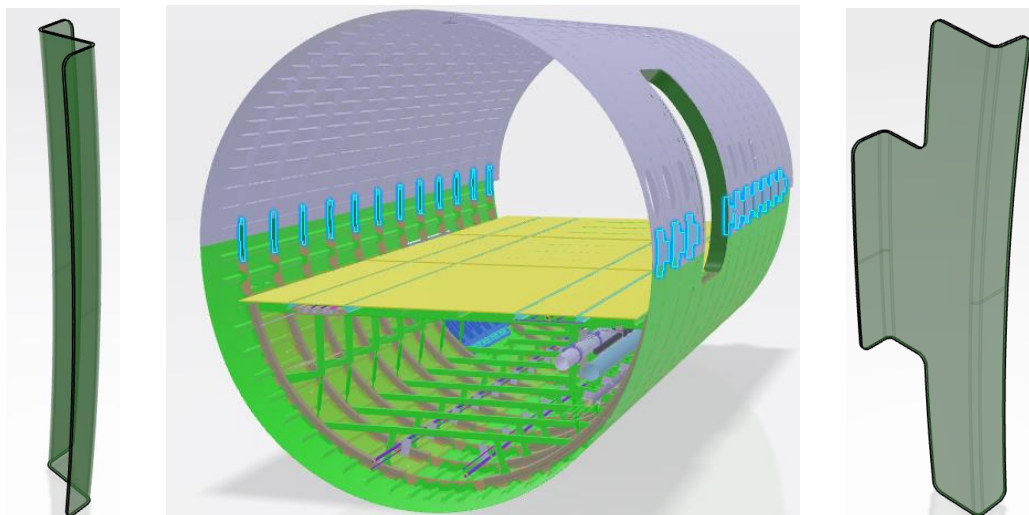

Figure 5: Frame coupling integration: Frame couplings differ per side.

Work Package Breakdown Structure

In order to achieve the different technical and technological challenges defined in the demonstrator, the Work Package Breakdown Structure and activity scope matrix shown in Figure 6 is recommended.

In this manner, each of the primary Work Packages (WP) addresses one of the Top Level Objectives (TLO) of this topic.

These are:

- Achievement of a high quality, stepped butt strap integration connecting the upper and lower fuselage skins
- Achievement of the electrical coupling of the upper and lower fuselage skins Lighting Strike Protection.

Furthermore, underlying developments and activities need to be conducted to enable the successful achievement of these TLO's. While the majority of of these are described in more detail within Chapter **Error! Reference source not found. Error! Reference source not found.**, special note should be made of the need to supply auxiliary structures and materials, such as counterholders, or safety relevant provisions and equipment. Depending on the technological variants chosen, a dedicated WP for this may be beneficial.

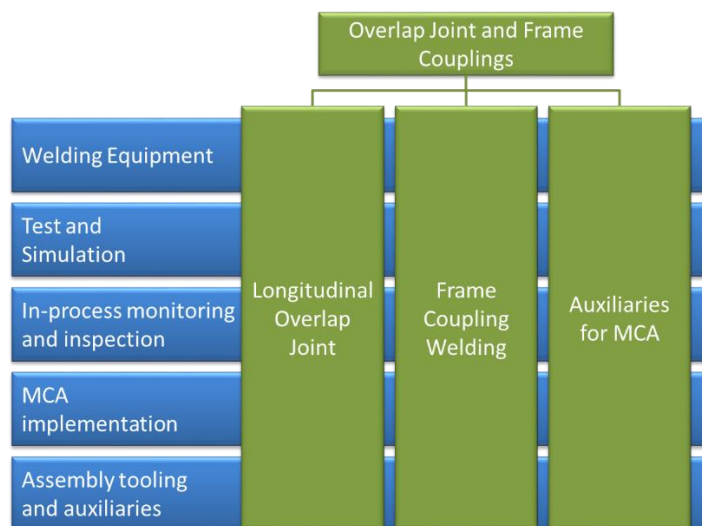

Figure 6: Work Package Breakdown Structure and key activity matrix

Project environment

The project addresses some of the most important interfaces with respect to the CleanSky 2 Large Passenger Aircrafts Multifunctional Fuselage. As such, the project may be led through WP2.1.3 Integrated concepts definition and maturation, but it requires a very open exchange between partners delivering the Lower and Upper Shell structures, the Main Component Assembly partnership (WP2.1.6), welding technology developers and associated project consortia.

Furthermore, cooperation with the complementary project responsible for the tooling development and supply for the butt strap joint is essential in order to enable electrical continuity across the overlap joint. An overview of the current WBS of the Multifunctional Fuselage is given in Figure 7.

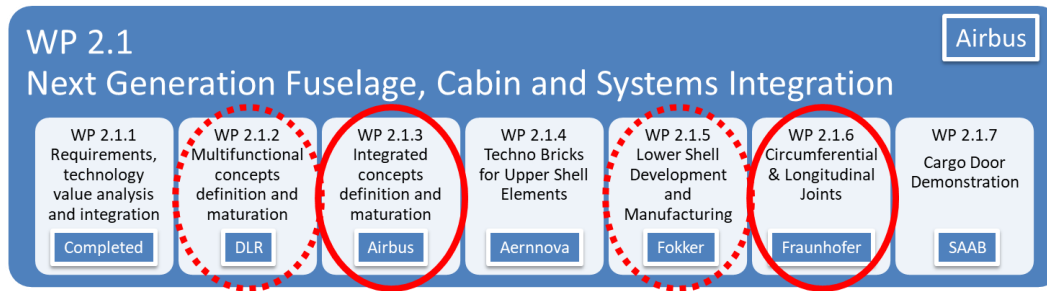

Figure 7: Next Generation Fuselage, Cabin and Systems Integration. Led through WP2.1.3 “Integrated concepts definition and maturation” a strong link to WP2.1.6 is required to WP2.1.6 Circumferential & Longitudinal Joints. In addition, close cooperation is expected in particular with WP2.1.2 and 2.1.5 where important welding developments are taking place.

2. Scope of work

Tasks		
Ref. No.	Title - Description	Due Date
TX.1	Requirements analysis and Functional Breakdown	T+1M
TX.2	Tooling Specific Design	T+6M
TX.3	Tooling manufacturing and delivery	T+11M
TX.4	On-site support	T+17M
TX.5	Process performance verification and analysis	T+18M
TX.6	Improved functionality implementation and verification on welding equipment	T+27M
TX.7	Documentation and Dissemination	T+28M
TX.8	Technological de-risking trials and simulation	T+30M
TX.1	Requirements analysis and Functional Breakdown	T+1M

Each of the Work Packages needs to conduct a number of tasks in order to fulfill the objectives of the topic:

Requirements analysis and Functional Breakdown

At the start of the project, the selected applicant shall receive the Requirements and Specification document as well as background information stemming from preparatory work conducted by the WP2.1 consortium. The applicant needs to analyse and further break-down these needs into tooling relevant requirements and functionalities. The outcomes of this activity will then serve as the main guiding principles for the specific tooling design phase. Particular emphasis will be placed on Health and Safety, Performance and Monitoring thereof.

Tooling Specific Design

The tacted Tooling Specific Design shall be characterized by regular exchanges between the lead tooling designers of the applicant in order to ensure compatibility, allow an early familiarization of users with the equipment and prioritize functionality integration.

Tooling manufacturing and delivery

At the end of this activity, the required tooling heads, test pieces, auxiliary structures and equipment shall have been supplied. A staggered delivery schedule is preferred over a single bulk delivery to facilitate project conduct and MCA integration. Specifically, tooling for the Overlap joint is expected by month 10 with Frame coupling integration tooling by month 11. At these dates, test pieces for

integration in the MCA are also required. Consumables and parts for the barrel demonstrator, such as the frame couplings with pre-integrated meshes for resistance welding, are required in month 13.

On-site support

The project shall provide on-site support and be responsible for the successful implementation of the tooling and equipment in the MCA. This covers both the initial tooling integration as well as the performance of the joining operations themselves.

Process performance verification and analysis

Running throughout the course of the project, this activity first verifies critical process parameters and tooling functionalities. It therefore focuses first on fundamental experimental and simulative studies regarding the principal process parameters before moving on to take special consideration of inspection and in-line process control techniques. Besides the applicant own work and results, data from the wider Demonstrator consortium will need to be considered during this development.

Improved functionality implementation and verification on welding equipment

Subsequent to the detailed performance analysis, lessons-learned shall be applied to the tooling design, in particular the end effector(s). These shall be verified, preferably experimentally within the timeframe of this project. The specific focus lies in the implementation of further in-line process monitoring and control methods with a view to directly feeding into the demonstrators Product Lifecycle Management Digital Twin within 3D Experience.

Documentation and Dissemination

All work packages shall strive to perform in particular scientific publications as well as support the standardization of thermoplastic welding processes when applied to commercial aircraft.

Technological de-risking trials and simulation

Running throughout the duration of the project, this activity encompasses all required testing and simulation activities. As such, it represents a crucial stream of coupon and element level manufacturing and performance trials. While initially this stream will need to focus strongly on the actual joining operations themselves, it will transform more towards monitoring, control and industrial integration as the project progresses. The applicant is expected to propose a list of relevant tests at coupon and barrel level.

3. Major Deliverables/ Milestones and schedule (estimate)

*Type: R= Report, RM= Review Meeting, D=Data, HW=HardWare

Deliverables			
Ref. No.	Title - Description	Type*	Due Date
D1	Tooling Specific Design Requirements Dossier	Report	T+1M
D2	Welding End effector and auxiliaries design	Data	T+7M
D3	Welding Technology: De-risking test and simulation intermediate report	Report	T+10M
D4	Delivery of Welding End effectors and auxiliaries	Hardware	T+11M
D5	Delivery of Welding Test pieces for Tooling verification	Hardware	T+11M
D6	Delivery of Frame couplings for Barrel closure	Hardware	T+13M
D7	Welding End effectors and auxiliaries integrated in MCA	Hardware	T+13M
D8	On-site support, Quality assurance completed	Report	T+18M
D9	Equipment optimization report	Report	T+28M
D10	Welding Technology: De-risking test and simulation final report	Report	T+29M
D11	Optimized welding equipment	Hardware	T+29M

Milestones (when appropriate)			
Ref. No.	Title - Description	Type*	Due Date
M1	Kick-off Meeting	Meeting	T0
M2	Tooling Intermediate Design Review	Review	T+4M
M3	Tooling Design Reviews	Review	T+7M
M4	Tooling Manufacturing Review and Delivery acceptance	Review	T+11M
M5	Barrel Joining Review: Tooling performance review	Review	T+18M
M6	Functionality optimization progress Review	Review	T+24M
M7	Final Project Meeting	Meeting	T+30M

In order to facilitate planning, the project is displayed within the context of the overall Multifunctional Fuselage in Figure 8.

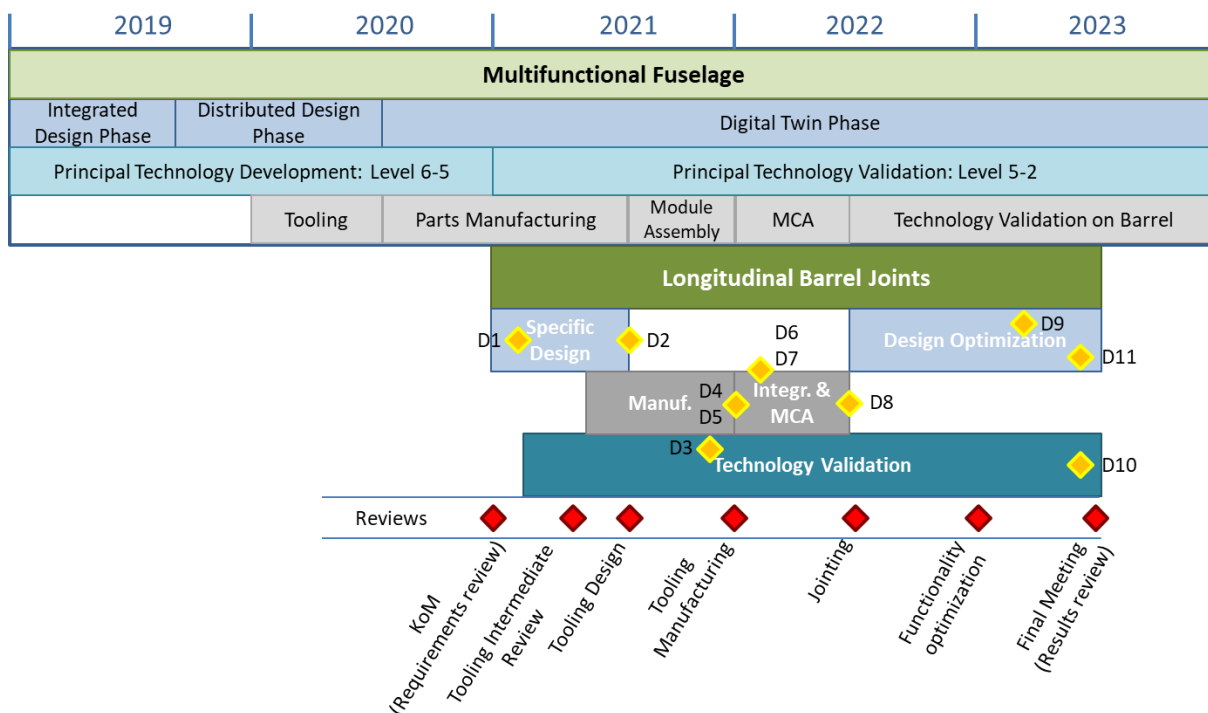

Figure 8: Timeline of the project in relation to the overall Multifunctional Fuselage. Deliverables and Milestones for this project are marked.

4. Special skills, Capabilities, Certification expected from the Applicant(s)

It is expected that the interdisciplinary core competences required for the successful delivery of this project can only be found by a highly competent consortium incorporating industrial and academic partners with proven and recognized core competences.

Essential:

- Skill: In-depth project management in time, cost and quality together with evidence of past experience in large project participation.
- Skill: Specific machine tool design, manufacture and support to industry proven on a regular and



recent basis

- Skill: Proven expertise in the provision of ultrasonic welding equipment
- Skill: Proven expertise in the development of resistance welding solutions
- Skill: Integration of electrically active and controlled members into CFRP material
- Skill: In-depth understanding of thermoplastic materials and welding thereof
- Skill: Online process monitoring and control for Quality Assurance
- Capability: In-house equipment for the chosen welding technologies
- Capability: Implementation of 3D Experience for the conduct of this project

Advantageous:

- Skill: Integrated Way-of-Working within a Product Lifecycle Management environment
- Skill: Manufacturing and Processing validation for large passenger aircraft, in particular for composites
- Skill: Experience with PAEK material family, preferably regarding welding
- Skill: Recognized successful collaborations in the fields of Manufacturing Engineering and Materials and Processes
- Skill: Utilization of 3D Experience in a partner environment

5. **Abbreviations**

CfP	Call for Proposals
CFRP	Carbon Fibre Reinforced Polymer
LSP	Lightning Strike Protection
MCA	Main Component Assembly
TLO	Top Level Objective
WP	Work Package

XIII. JTI-CS2-2020-CfP11-LPA-02-35: Innovative disbond arrest features for long thermoplastic welded joints

Type of action (RIA/IA/CSA):		IA	
Programme Area:		LPA	
(CS2 JTP 2015) WP Ref.:		WP 2.1.5	
Indicative Funding Topic Value (in k€):		750	
Topic Leader:	Fokker	Type of Agreement:	Implementation Agreement
Duration of the action (in Months):	24	Indicative Start Date (at the earliest)³²:	> Q4 2020

Topic Identification Code	Title
JTI-CS2-2020-CfP11-LPA-02-35	Innovative disbond arrest features for long thermoplastic welded joints
Short description	
<p>Long welded joints in thermoplastic composites such as stringer to skin offer benefits in weight and cost. Damage and propagation thereof in long welded joints can be mitigated by means of a disbond arrest feature like a friction stir welded insert. This topic involves fundamental research into:</p> <ul style="list-style-type: none"> • Analysis and validation of damage propagation along a welded thermoplastic joint • Development a of ‘dustless’ disbond arrest feature like friction stir welding 	

Links to the Clean Sky 2 Programme High-level Objectives³³				
This topic is located in the demonstration area:		Cabin & Fuselage		
The outcome of the project will mainly contribute to the following conceptual aircraft/air transport type as presented in the scene setter:		Advanced Long-range Advanced Short/Medium-range		
With expected impacts related to the Programme high-level objectives:				
Reducing CO₂ emissions	Reducing NO_x emissions	Reducing Noise emissions	Improving EU Competitiveness	Improving Mobility
<input checked="" type="checkbox"/>	<input type="checkbox"/>	<input type="checkbox"/>	<input checked="" type="checkbox"/>	<input type="checkbox"/>

³² The start date corresponds to actual start date with all legal documents in place.

³³ For further info see Chapter 1 “Introduction to the Programme Scene Setter / Objectives” with key technology themes / demonstration areas. Detailed information available in the CS2 Development Plan accessible via the Clean Sky JU Website and Funding and Tender Portal.

1. Background

Large Passenger Aircraft (LPA) Platform 2 – Multifunctional Fuselage Demonstrator:

The objective of Large Passenger Aircraft (LPA) Platform 2 WP2.1 Multifunctional Fuselage Demonstrator (MFFD) is to validate high potential combinations of airframe structures, cabin, cargo, and system elements using advanced materials and applying innovative design principles in combination with the most advanced system architecture of next generation cabin. The demonstration will enable aircrafts higher production rate together with a fuselage weight and recurring cost reduction.

The driver of this approach is to attain a significant fuel burn reduction by substantially reducing the overall aircraft energy consumption, apply low weight systems and architecture integration to be able to cash in weight potentials in the structural design of the fuselage and the connected airframe structure.

Design activities started on the development of the lower half of the multifunctional fuselage demonstrator (MFFD). This part of the project will develop, manufacture and deliver a 180° full scale multi-functional integrated thermoplastic lower fuselage shell, including cabin and cargo floor structure and relevant main interior and system elements. The demonstrator has a length of around 8m, and a varying radius between 2 and 2.5m, similar to an A321 lower half fuselage.

The applicants work will involve key aspects of the activity on the MFFD and as such is linked to WP2.1.5.

Figure 1 provides a view on the lower half fuselage module concept with some characteristic features highlighted. The lower fuselage module itself is divided into two main modules: the lower fuselage stiffened shell module and the passenger floor and cargo hold module.

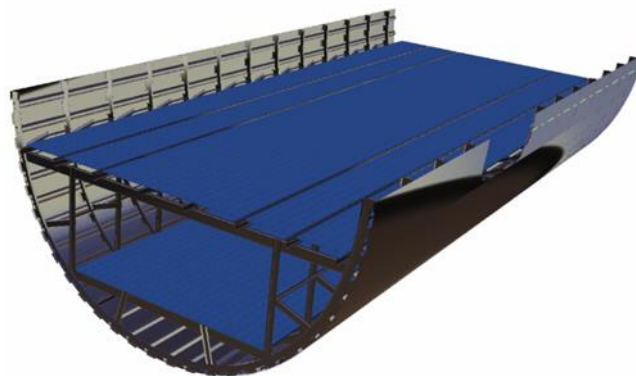

Figure 1: Overview of the MultiFunctional Fuselage demonstrator, lower half

Innovative disbond arrest features for long thermoplastic welded joints

Aircraft structural weight depends on allowable minimum thicknesses and stiffness which in turn are often determined through allowables and minimum thicknesses for countersunk fasteners. To date, mechanical fastening is the primary joining technique in aerospace structures, both in metallic as well as composite components. For thermoplastic composites however, welding offers a far more efficient joining method and has the potential to relax thickness requirements which leads to significant weight savings. Despite this significant advantage, the majority of welded joints still have fasteners due to stringent certification guidelines for bonded joints that are also applied conservatively to welded joints.

For bonded joints, AMC 20-29 state:

"For any bonded joint, the failure of which would result in catastrophic loss of the aeroplane, the limit load capacity must be substantiated by one of the following methods:

(i) The maximum disbonds of each bonded joint consistent with the capability to withstand the loads in paragraph (a)(3) of this section must be determined by analysis, tests, or both.

Disbonds of each bonded joint greater than this must be prevented by design features; or
(ii) Proof testing must be conducted on each production article that will apply the critical limit design load to each critical bonded joint; or
(iii) Repeatable and reliable non-destructive inspection techniques must be established that ensure the strength of each joint."*

*) design feature in this context is the same as a Disbond Arrest Feature (DAF)

In relation to the certification guidelines, the aim of this topic is to advance towards a certifiable joint with two main objectives:

1. Exploration of novel disbond arrest features with particular emphasis on automated manufacturing process
2. Physical validation of the influence of specific parameters i.e. material, DAF pitch and loading conditions on the disbond propagation mechanism resulting in some initial design guidelines.

The lower half of the thermoplastic multifunctional fuselage demonstrator consists of omega stringers that are welded to the skin, see figure 2. The DAFs are primarily envisioned to be developed for these long welded joint. The frames are connected to the skin using frame clips which make a natural location for a disbond arrest feature as this is where concentrated out of plane loading acts on the joint.

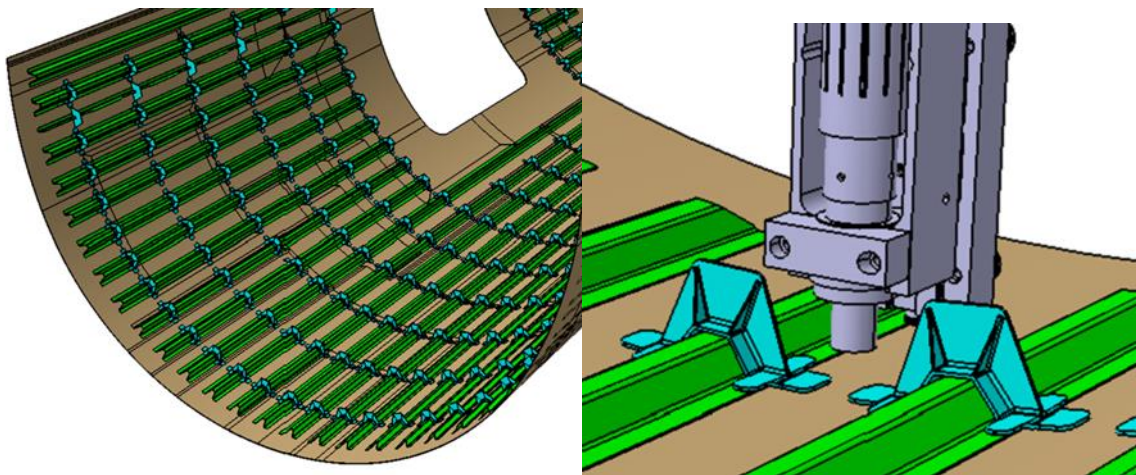

Figure 2: Stringers and clips welded to a thermoplastic fuselage

In the context of this demonstrator top level requirements to disbond arrest features are:

- The installation process must be dustless, no drilling & fine dust generation is allowed
- The solution should have good out-of-plane load bearing capability
- It must be feasible to have a full automated process, to ensure short cycle times and low cost
- The DAF must be installed at the inside on top of the stringer flanges/frame clip flanges and thus facilitate edge distance around 15mm to an upward edge.
- Total thickness of frame clip, stringer and skin vary between 4 and 10mm

Friction stir welded rivets are considered to offer a promising candidate solution for a DAF as no mechanical drilling is used and the process is relatively fast and low cost.

2. Scope of work

The scope of work is summarized in three work packages as stated in the table below.

Work packages*		
Ref. No.	Title - Description	Due Date
WP1	Project management, dissemination and exploitation	M24
WP2	Development and manufacturing of Disbond Arrest Feature	M17
WP3	Validation of disbond propagation mechanism	M23

(* note that the work package numbering shall start with 1

WP1 Project management, dissemination and exploitation

The first work package includes all project management, dissemination and exploitation activities. It will be running through the whole project. For the project management part, typical activities include project administration, financial management, scheduling and risk management. A very important aspect of any Clean Sky 2 funded project is dissemination and exploitation. The applicant is expected to disseminate as appropriate through peer reviewed journals and present a clear vision on exploitation of the technology.

WP2 Development and manufacturing of Disbond Arrest Feature

The scope of this work package is to mature the specific dustless DAF manufacturing and/or installation process in the context of a fully automated production environment. The applicant is asked to present a development manufacturing plan for the installation of DAF at the clip, stringer, skin joint and at the stringer skin joint. Demonstration of a manufacturing approach that allows for installation of the DAF in close proximity of upward flanges is part of this work package.

If successful, the topic manager would like to invite the applicant to demonstrate this technology on parts of the demonstrator.

WP3 Validation of disbond propagation mechanism

The applicant will start with a short max 2-month literature review on Disbond Arrest Features (DAF) with emphasis on validation means. This literature review combined with inputs from the Topic Manager will be the basis for a test validation plan. For this topic, the primary means of validation will be through fatigue testing. The evaluation of the test results will lead to an initial set of design guidelines. One important design parameter is the minimum distance between two consecutive DAFs. The proposed test program should provide more insight in the justification of specific distances.

3. Major Deliverables/ Milestones and schedule (estimate)

*Type: R= Report, RM= Review Meeting, D=Data, HW=Hardware

Deliverables			
Ref. No.	Title - Description	Type*	Due Date
D1	Project management, dissemination and exploitation plan	R	M2
D2	Manufacturing development plan for DAF installation	R	M4
D3	Evaluation report on demonstration of DAF installation	R,D	M18
D4	Industrialisation plan	R	M22
D5	Structural test plan	R	M4
D6	Test evaluation report inc. data	R, D	M22

Milestones (when appropriate)			
Ref. No.	Title - Description	Type*	Due Date
M1	Kick-off meeting	RM	M1
M2	Definition and test preparation review meeting	RM	M4
M3	Manufacturing review meeting	RM	M12
M4	Test evaluation review meeting	RM	M22
M5	Final Evaluation & industrialisation review meeting	RM	M23

Gantt Chart for deliverables and Milestones

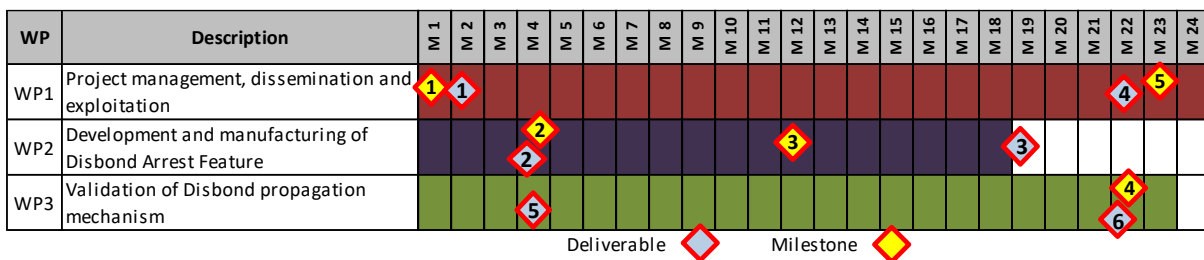

4. Special skills, Capabilities, Certification expected from the Applicant(s)

Essential:

- Sound technical knowledge in the field of proposed contributions and ability to demonstrate that their knowledge is widely recognized.
- Sound knowledge in structural fatigue testing of these structures as well as the capability to manufacturing test articles.
- Availability of Equipment and demonstrated expertise in the automated installation of the Disbond Arrest Feature

Advantageous:

- Work-shop facilities in line with the proposed deliverables and associated activities or, if such equipment is not available, existing relation with institutions or companies that accommodate such equipment.
- Experience in writing journal articles in the related field
- Evidence of the ability to cope with the required high level of adequate resources in qualified personnel, required tools and equipment.
- Demonstrated experience in management, coordination of development projects

5. Abbreviations

AMC	Acceptable Means of Compliance
CS	Certification Specification
DAF	Disbond Arrest Feature
LPA	Large Passenger Aircraft
MFFD	MultiFunctional Fuselage Demonstrator
WP	Work Package

XIV. JTI-CS2-2020-CfP11-LPA-02-36: Large scale aircraft composite structures recycling [ECO]

Type of action (RIA/IA/CSA):		IA	
Programme Area:		LPA [ECO]	
(CS2 JTP 2015) WP Ref.:		WP 2.4	
Indicative Funding Topic Value (in k€):		1800	
Topic Leader:	Airbus	Type of Agreement:	Implementation Agreement
Duration of the action (in Months):	36	Indicative Start Date (at the earliest)³⁴:	> Q4 2020

Topic Identification Code	Title
JTI-CS2-2020-CfP11-LPA-02-36	Large scale aircraft composite structures recycling [ECO]
Short description	
<p>Large scale carbon fiber composite structures have become a standard element of modern aircraft and in future aircraft the level of composite material content, the total amounts in mass and volume, as well as the combination with other materials in “hybrid” parts or components is expected to grow substantially. This brings new opportunities to further improve aircraft performance and competitiveness in the industrial production but also new challenges in other areas: the end of life. Within this project, methods for the salvaging, dismantling and recycling of a large transport aircraft with large, complex CFRP composite structures shall be investigated and demonstrated. A special focus will be put on the areas of health and environment, with the physical means to protect environment and men during the dismantling process.</p>	

Links to the Clean Sky 2 Programme High-level Objectives ³⁵				
This topic is located in the demonstration area:		Eco design		
The outcome of the project will mainly contribute to the following conceptual aircraft/air transport type as presented in the scene setter:		Advanced long range Advanced Short/Medium-range		
With expected impacts related to the Programme high-level objectives:				
Reducing CO ₂ emissions	Reducing NO _x emissions	Reducing Noise emissions	Improving EU Competitiveness	Improving Mobility
<input type="checkbox"/>	<input type="checkbox"/>	<input type="checkbox"/>	<input checked="" type="checkbox"/>	<input type="checkbox"/>

³⁴ The start date corresponds to actual start date with all legal documents in place.

³⁵ For further info see Chapter 1 “Introduction to the Programme Scene Setter / Objectives” with key technology themes / demonstration areas. Detailed information available in the CS2 Development Plan accessible via the Clean Sky JU Website and Funding and Tenders Portal.

1. Background

Large scale carbon fiber composite structures have been in use since the early 80s, in the vertical tail plane of Airbus aircraft. Once such aircraft were retired, those structures could still be dismantled using conventional methods thus posing no issue to existing end-of-life routes. But with the introduction of CFRP as a major construction material in the latest generation of aircraft as the A350, new challenges for the end-of-life processes of such aircraft arose.

The critical issue is the use of CFRP for the fuselage and wing. While aluminum aircraft could simply be dismantled with large hydraulic scissors and comparable separation methods, these approaches don't work for composite aircraft. E.g. in the root section of the A350 wing, carbon fiber laminates of several centimeters thickness can be found. Such thick CFRP laminates cannot be cut with a hydraulic scissor anymore and pose a problem for the dismantling of such structures once they have to be taken apart.

Therefore it will be necessary to establish an appropriate technique to separate functional parts of other materials embedded in complex components made from CFRP composite (hybrid materials), with the latter being a trend to provide new design opportunities for CFRP primary and also secondary structures.

In addition to the problems CFRP poses due to the strength of the material itself, cutting or sawing composite materials requires significant technical means for the techniques and cutting materials themselves, as well as requiring intense care to protect the direct environment and people from dust and debris caused during the dismantling process.

Once dismantled and recovered from the aircraft, such composite structures can nowadays be recycled through processes like pyrolysis to recover the fibre materials or discarded through high temperature incineration. At the scale targeted here, this will require a comminution process, as conventional recycling ovens do not allow for the direct introduction of whole fuselages or sections, but are rather restricted due to oven (door) sizes which range from roughly 1x0,5m to about 2,5x2,5 m at different recycling providers. But once brought to adequate size for recycling the processes therefore are well known.

To actually close the material cycle, the recycled carbon fibers (rCF) should then actually be reused in new serial applications, a gap the composite industry has yet to close. Hence identifying and developing applications for the re-application of rCF in new materials and especially large volume part applications is an integral part of the circular economy's success.

2. Scope of work

The core element of this CfP is the identification and demonstration of industrially and environmentally safe methods for the dismantling and recycling of carbon fibre composite aircraft. The assumption shall be that an Airbus A350 or comparable aircraft has been grounded at an airport within Europe, with a technical issue that deems it to be dismantled and removed from the airport without interrupting the ongoing airport operation as worst case scenario. Besides that the standard scenario of a planned end-of-life with shall be investigated where the aircraft can be taken to a defined dismantling site.

In the context of the activities in CS2 LPA WP2.4, a close exchange between the supporting activities about part design and manufacturing technologies will be required as to align the final dismantling technologies (e.g. debonding on demand) with the initially developed and used joining technologies, to include an aspect of "design for recycling" in early development phases of such new aircraft structures.

Therefore, this CfP includes the following areas of work:

- Legal and environmental requirements analysis

- Legal framework: what is the legal framework in which the dismantling of aircraft on an operating airport can take place. This includes, but is not limited to, airport regulations and governmental/legal regulations.
- Environmental and safety requirements: how can the direct (and indirect) environment be protected from byproducts of the dismantling process, e.g. CFRP fragment debris and dust, polluted slurry from coolant for cutting processes. What personal safety precautions are required from personnel working on-site, what is the perimeter in which safety precautions have to take place?
- Aircraft general preparation
 - Valorisation of reuseable parts: before the process of separation of the CFRP fuselage and wing structures into transportable structure size, valorisation of reuseable structures of the aircraft shall take place. In principle, this can be represented by existing processes of today where engines, avionic systems, seats and other elements of the aircraft are removed and refurbished for later sale and reuse. But with the increased life span of composite materials, new areas of reuse - like the complete reuse of flaps or Vertical Tail Planes – can be investigated.
 - Hazardous materials handling: The later dismantling process requires the removal of any liquids, harmful substances (hydraulic fluids, fuels etc.) and potentially harmful objects (e.g. batteries) that could pose a harm to the environment or people or become a barrier for the separation of parts (local accumulations of material, high location of high performance metals and composite/metal-hybrids. Identifying what those elements are and how to remove them safely is the main area of work herefor.
 - “CFRP Aircraft End-of-life process map”: before an actual dismantling can take place, a clear planning including aircraft engineering has to take place to derive the optimal cut position and angles, what cutting methods shall be used, the recommended process parameters therefor and in what sequence the cuts shall take place. Significant effort should be put into a determination of the continuously changing center of mass of the aircraft during this process to identify the adequate hoisting points thus reducing the risk of any part of the aircraft collapsing or tilting in an harmful way. Output of this work shall be a process sequence (what has to be cut where, into how many pieces of what sizes using which defined technical means) and a graphical representation the chosen target aircraft giving specific dismantling guidelines (cutting sequence, hoisting positions etc.).
- Dismantling of carbon composite aircraft
 - Dismantling site preparation: the site and perimeter where the phsical dismantling of CFRP aircraft has to take place needs to be prepared to avoid any contaminants from the cutting process or other materials leaking uncontrollably into the ground or sewer system. These means of preparation have to be defined.
 - Aircraft dismantling preparation: Besides the general salvaging of parts for re-use described earlier, the aircraft has to be prepared for the dismantling process itself. This can include local safety measures that have to be applied, hoisting points that are have to be added to the existing structure, markings that are used as orientation during the cutting process.
 - Hoisting approach: What means of hoisting can be used to move or secure large scale parts once the dismantling has started. Additionally, the weight distribution of the aircraft in relation to the position of cuts needs to be taken into account to safely hoist the cut parts. Based on the “Aircraft EoL Map” from the prior workpackage, a sound approach to hoisting has to be defined.
 - Dismantling approach and technologies/separation methods: How will the dismantling of an

aircraft with composite fuselage and wing be approached? What are sensible sizes for the cut elements, what are the boundaries in which to operate (e.g. defined by transportable size or by recycling-ovens sizes)? What technical methods can be used to cut entire fuselage sections? What specific approaches can be developed to disassemble thermoplastic parts/joints (e.g. “debonding on demand”)?

- Recycling of large scale composite structures

As the recovery of carbon fibres from CFRP materials through pyrolysis processes is already industrially viable and explored in a previous project, working on these shall not be part of this CfP. Rather the prior and posterior steps require further development. Though one workpackage is planned to allocate budget to a physical recycling trial from the parts recovered in the scope of this CfP's work, to be used on the workpackage “Valorisation of recycled carbon fibre materials.

- CFRP comminution methods: due to its material composition CFRP materials are hard to cut or crush into smaller parts which then can be fed into recycling processes. Thus, a comparative investigation of comminution methods to identify the most cost-effective way is required for this CfP.
- Recycling of recovered CFRP parts: an exemplary amount of CFRP parts recovered in the scope of this CfP's work shall be recycled using existing means, e.g. pyrolysis processes, to acquire fibres for the valorisation-workpackage below.
- Valorisation of recycled carbon fibre materials: identification of (a set of) applications for rCF. It is not necessary to physically realize a new rCF-part within this CfP, but a set of potential parts alongside explanations why this is a good candidate in terms of value and potential amount of rCF materials reused therefor shall be given.

- Logistics: to reduce the time on site that is required for an aircraft's dismantling it might be desired to only cut large scale fuselage sections and transport them to another site for further treatment. Within this part of the CfP it shall be investigated how the transport of recovered parts on site can be performed, what means of transport are recommended and how a logistics chain for the dismantling of such an aircraft could look, starting at the point where the aircraft is taken out of service up to the moment the recovered parts go into the individual recycling processes.

- Environmental and human protection means

- Environmental protection: to secure the direct and indirect environment from contamination from the dismantling process, potential threats shall be identified and ways of mitigation proposed. This includes dust and debris protection, recovery of polluted substances like coolant used for cutting processes and other potential threats to the environment.
- Human protection: identification of threats to the health of workers and people in the perimeter of the dismantling site and proposal of adequate safety precautions.

- Concluding activities

- “CFRP Aircraft End-of-life process map”: before an actual dismantling can take place in a real life scenario, a clear planning including aircraft engineering has to take place to derive the optimal cut position and angles, what cutting methods shall be used, the recommended process parameters therefor and in what sequence the cuts shall take place. Significant effort should be put into a determination of the continuously changing center of mass of the aircraft during this process to identify the adequate hoisting points thus reducing the risk of

any part of the aircraft collapsing or tilting in a harmful way. Output of this work shall be a process sequence (what has to be cut where, into how many pieces of what sizes using which defined technical means) and a graphical representation of the chosen target aircraft giving specific dismantling guidelines (cutting sequence, hoisting positions etc.).

This work shall summarize the prior technical workpackages in the form of a full process description of how to approach the dismantling and recovery of a composite aircraft.

- Life Cycle analysis: Performing a life cycle inventory of all relevant processes and materials to contribute to the End-of-life part of a full life cycle analysis to be performed in the frame of the ecoTA.
- Cost analysis: Finally, a full description of estimated costs/benefits as well as time required to perform the dismantling and recovery of an entire composite aircraft shall be given.

The core of this project will consist of three major areas:

- Adaptation of state-of-the-art dismantling methods, known from metallic aircraft, for tackling CFRP structures in non-dismantling-dedicated (mobile) locations, including the development of the necessary means of environmental and personnel protection on the dismantling site against CFRP dust, fragments and cutting slurry.
- The development of new dismantling technologies focussed on technologies applicable for thermoplastic CFRP material systems. Specifically, the idea of “debonding on demand” shall be pursued within the scope of this CfP (e.g. through local heating of weld lines).
- The development of a future dismantling and recycling supply chain covering the end-of-life of novel composite aircraft.

Ref. No.	Title	Description	Due date
WP1	Legal and environmental requirements		
WP1.1	Legal framework	Review of legal framework and regulations	T0+6
WP1.2	Environmental and safety requirements	Analysis of requirements concerning the safety of personnel and the protection of the direct environment from pollution/contaminants	T0+6
WP2	Aircraft general preparation		
WP2.1	Valorisation of reusable parts	Identification of aircraft parts that can directly be reused or otherwise valorised (engines, avionics systems, cabin etc.)	T0+12
WP2.2	Hazardous materials handling	Definition of what hazardous substances have to be taken into account and how to prepare the fuselage accordingly	T0+18
WP3	Dismantling of carbon composite aircraft		
WP3.1	Dismantling site preparation	Preparatory activities required to secure the site of aircraft dismantling	T0+12
WP3.2	Aircraft dismantling preparation	Preparatory activities required to secure the aircraft during dismantling, e.g. coverings, attachment of additional hoisting points	T0+18
WP3.3	Hoisting approach	Identification of technical means and specific processes to hoist and move	T0+18

Ref. No.	Title	Description	Due date
		structures of the aircraft	
WP3.4	Dismantling approach and technologies/ separation methods	Identification and demonstration of separation and segregation methods for large scale carbon composite structures, esp. debonding of welded joints in thermoplastic composites	T0+24
WP4	Recycling of large scale composite structures		
WP4.1	CFRP comminution methods	Identification and demonstration of cost-effective comminution methods for large and thick CFRP structures	T0+21
WP4.2	Recycling of recovered CFRP parts	Performing the physical recovery of carbon fibers from parts recovered within this CfP using state-of-the-art methods (e.g. pyrolysis)	T0+24
WP4.3	Valorisation of recycled carbon fibre materials	Proposal for a commercial valorization system to monetize the performed work	T0+30
WP5	Logistics	Handling and transport of dismantled composite structures on-site and between dismantling site and recycling facility or other points of further processing	T0+12
WP6	Environmental and human protection		
WP 6.1	Environmental protection	Identification and demonstration of physical means to protect the dismantling site and its perimeter from contamination	T0+18
WP 6.2	Human protection	Personal safety precautions that have to be performed by personnel working on and around the dismantling site and its perimeter.	T0+18
WP7	Concluding activities		
WP7.1	“CFRP Aircraft End-of-life process map”	Full plan on the sequence and technologies used for dismantling summarizing the prior WPs	T0+36
WP7.2	Cost analysis	Full description of estimated costs/benefits, as well as time required to perform the dismantling and recovery of an entire composite aircraft	T0+36
WP7.3	Life cycle inventory/LCA	LCA-analysis and reporting for all relevant processes performed	T0+30

3. Major Deliverables/ Milestones and schedule (estimate)

*Type: R= Report, RM= Review Meeting, D=Data, HW=HardWare

Deliverables			
Ref. No.	Title - Description	Type*	Due Date
D1.1	Legal framework and requirements report	R	T0+6
D1.2	Environmental and safety requirements analyzed and means defined (report)	R	T0+6
D2.1	Report on reusable part valorisation	R	T0+12
D2.2	Guideline/report on how to prepare for hazardous or otherwise dangerous substances	R	T0+18
D3.1	Report on required activities for dismantling site preparation based on legal, operational and environmental requirements	R	T0+13
D3.2	Report on required activities for preparing the actual dismantling/cutting processes of the aircraft	R	T0+24
D3.3	Report/presentation on how hoisting large scale CFRP structures can be performed	R	T0+18
D3.4	Detailed report and presentation on the technologies and process sequence for the dismantling a composite aircraft, including physical demonstrations at relevant scale	R; D	T0+24
D4.1	Presentation and physical demonstration of comminution methods	HW	T0+18
D4.2	Availability of a significant amount of recycled carbon fibres from actual aircraft parts	HW	T0+24
D4.3	Report and presentation on potential applications of recycled carbon fibers	R	T0+30
D5	Report on on-site (dismantling site) and of-site logistics (between dismantling and further processing)	R; D	T0+12
D6.1	Detailed report, presentation and proof of viability for investigated and proposed solutions for environmental protection of the dismantling site	R	T0+18
D6.2	Detailed report on the required safety precautions for personnel during the dismantling	R	T0+18
D7.1	Detailed report and presentation on the full process sequence for CFRP aircraft dismantling and the technologies used therefor	R	T0+36
D7.3	Environmental and safety requirements analyzed and means defined (report)	D	T0+30

Milestones (when appropriate)			
Ref. No.	Title - Description	Type*	Due Date
M1	Legal, safety and environmental framework report and commercial assessment	R	T0+12
M2	Dismantling technologies and logistics concept	HW; R	T0+18
M3	Physical trials performed	HW; R	T0+24
M4	LCA assessment	R; D	T0+30
M5	Full supply chain concept proposal	R	T0+32

Milestones (when appropriate)			
Ref. No.	Title - Description	Type*	Due Date
M6	Final presentation of results	R	T0+36

4. Special skills, Capabilities, Certification expected from the Applicant(s)

Essential:

- Contractor has proven experience in the dismantling of carbon fiber composite parts and handling of large scale structures.
- Applicant(s) must have a detailed knowledge about the state of the art in carbon fiber materials, their recycling and processing technologies as well as existing markets and legal barriers.
- Applicant(s) has to have a dedicated R&D department for material and process research to cover the development of novel de-bonding methods.
- Applicant(s) has the capability to measure and collect economic process data for industrial processes.
- Applicant(s) requires details knowledge about legal requirements related to the matter of the topic

Advantageous:

- Applicant has or have access to a dedicated organisation for environmental safety

XV. JTI-CS2-2020-CfP11-LPA-02-37: Thermoplastic fuselage repair process integrated on manufacturing line

Type of action (RIA/IA/CSA):		IA	
Programme Area:		LPA	
(CS2 JTP 2015) WP Ref.:		WP 2.4	
Indicative Funding Topic Value (in k€):		800	
Topic Leader:	Airbus	Type of Agreement:	Implementation Agreement
Duration of the action (in Months):	30	Indicative Start Date (at the earliest)³⁶:	> Q4 2020

Topic Identification Code	Title
JTI-CS2-2020-CfP11-LPA-02-37	Thermoplastic fuselage repair process integrated on manufacturing line
Short description	
<p>Development of new technologies for in-house repair (rework) for structural and non-structural applications on Single Part, Major Component Assembly and Final Assembly Line level. Two general concepts shall be investigated in parallel:</p> <ul style="list-style-type: none"> • Welded thermoplastic Pre-consolidated Repair-Patch with parent material • In-Situ Layer-by-Layer Integration of Repair Patch <p>The developed approaches have to be demonstrated on representative structural detail level, taking account the local design and thermal distribution into the structure related to typical design of fuselage structures.</p>	

Links to the Clean Sky 2 Programme High-level Objectives ³⁷				
This topic is located in the demonstration area:		Cabin & Fuselage		
The outcome of the project will mainly contribute to the following conceptual aircraft/air transport type as presented in the scene setter:		Advanced long range Advanced Short/Medium-range		
With expected impacts related to the Programme high-level objectives:				
Reducing CO₂ emissions	Reducing NO_x emissions	Reducing Noise emissions	Improving EU Competitiveness	Improving Mobility
<input checked="" type="checkbox"/>	<input type="checkbox"/>	<input type="checkbox"/>	<input checked="" type="checkbox"/>	<input type="checkbox"/>

³⁶ The start date corresponds to actual start date with all legal documents in place.

³⁷ For further info see Chapter 1 "Introduction to the Programme Scene Setter / Objectives" with key technology themes / demonstration areas. Detailed information available in the CS2 Development Plan accessible via the Clean Sky JU Website and Funding and Tenders Portal.

1. Background

The objective of the work is to develop Repair / Rework capabilities for Thermoplastic Fuselage Structures within Platform 2. The development of repair solutions is mandatory for thermoplastic fuselage and targeted application of the repair principle is the multifunctional fuselage demonstrator. The parallel development of technologies for TP-Repair is mandatory as enablers to ensure a reparability of the Demonstrator in case of any damages during production or installation and to ensure reparability for any derived serial solution in the future.

Target is the development of advanced thermoplastic flush repair principles for usage in production environment (rework) based on the requirements provided by WP2.1 and WP2.3.

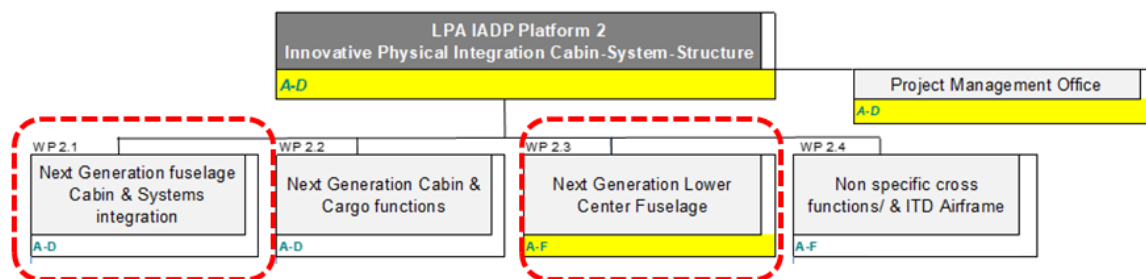

The developed solutions shall be applicable on Single Part Level, on Major Component Assembly Level as well as in Final Assembly Line Environment, taking into account specificities as substructures, accessibility, installed Systems and Cabin components, Lightningstrike Protection and Painting.

The state of the art of thermoplastic repair is based on bonded repair, with the associated features and limitations due to possible weak bond (or kissing bond). Today no repair-technology utilizing welding as major benefit of thermoplastic materials is available. Innovative content of the topic is to investigate the thermoplastic welding as repair solution, as welding is one of the major benefit of thermoplastic regarding thermoset. Novel approaches for welded and in situ consolidated repair principles shall be investigated and developed in the following two streams:

The first development stream covers structural repair solutions based on pre-manufactured hard thermoplastic patches of the parent material, which are integrated into the parent structure by means of welding. The properties of the parent structure as well as of the patch after welding have to be maintained according to the initial specification, to be provided by the topic manager.

The second development stream covers structural and non-structural repairs based on in-situ creation of the repair patch. This can be based on a layer-by-layer approach (structural repair) or by a 3D printing or shortfibre approach (non-structural). The properties of the parent structure as well as of the patch (for structural applications) after in situ placement have to be maintained according to the initial specification, to be provided by the topic manager. Specific development target solutions with one-side accessibility are preferred (repair at FAL level with installed interior / systems).

Targeted Maturity for both streams at End of Project: TRL3

The development is targeting the rework process, the industrialization on demonstrator level and the validation of the mechanical properties incl. state of the art NDI inspections of the final repair based on the requirements of WP 2.1 and WP 2.2. Also the principle transfer of the developed solutions towards in-service applications shall be investigated and qualitatively evaluated. A roadmap towards TRL6 is expected in terms of process maturity as well as industrialization infrastructure development needs.

A potential application of (intermediate) results on existing full scale demonstrator-structures of WP has

to be prepared and developed.

Out of Scope is the development of machining / scarfing operations to remove the damaged area and to prepare the parent structure for the integration of the repair. Also the Production capabilities of standard pre-consolidated patches is not part of the target development, except any potential process-related integration of production-aids for the welding process. Solutions based on adhesive Bonding are also not targeted in this CFP. No NDI Development shall be performed.

2. Scope of work

Tasks		
Ref. No.	Title - Description	Due Date
Task 1	Definition of Requirements	T0+2
Task 2	Screening and qualitative comparison of possible welding technologies for hard patch repair for Single Part, MCA and FAL application	T0+6
Task 3	Screening and qualitative comparison of possible technologies for In-Situ Repair Patch creation for Single Part, MCA and FAL application	T0+6
Task 4	Development and validation of Hard Patch Welding solution on coupon and element level (TRL3)	T0+18
Task 5	Development and validation of In-Situ-Repair-Patch Solution on coupon and element level (TRL3)	T0+24
Task 6	Demonstration of transfer on structural detail level (FAL/MCA) and demonstrator applicability	T0+29
Task 7	Technology comparison, applicability mapping and Roadmap to TRL6	T0+30

Task 1:

Definition of the specific repair requirements for in-production-repair applications (rework) based on requirements and materials provided by the topic manager.

Differentiation between Single-Part, Major Component Assembly and Final Assembly production environment and basic compilation of requirements for transfer to in-service repair applications.

Task 2:

Screening of possible welding technologies for hard patch repair for Single Part, MCA and FAL application preferably based on technologies selected for the full scale demonstrator of WP 2.1 and 2.3 and agreed with the topic manager. Qualitative comparison for the different application scenarios.

Down selection of suitable welding technology for all application scenarios.

Task 3:

Screening of possible technologies for in-situ repair-patch integration for Single Part, MCA and FAL application for structural and non-structural applications. Qualitative comparison for the different application scenarios. Down selection of suitable technology for all application scenarios.

Task 4:

Development and validation of technology selected in Task 2 (welded hard patch) including manufacturing process development and characterization and validation of structural performance of the welding, the patch and the parent structure after welding in accordance with the material specification and design allowables provided by the topic manager.

Target: TRL 3 demonstrated for selected Technology and application scenario(s).

Task 5:

Development and validation of technology selected in Task 3 (in-situ patch creation) including manufacturing process development and characterization and validation of structural performance of the welding, the patch and the parent structure after welding in accordance with the material specification and design allowables provided by the topic manager.

Target: TRL 3 demonstrated for selected Technology and application scenario(s).

Task 6:

Demonstration and validation of developed technologies (Task 4 & 5) on structural detail level (FAL / MCA) with representative specimens including targeted geometrical complexity. Simulation of relevant environment (accessibility, position of Part in assembly environment and presence of system installation and/or cabin components) on lab-scale. Preparation and support of planned application on full scale demonstrators.

Task 7:

Evaluation and comparison of results for all investigated Technologies with regards of applicability for different damage scenarios, application environments (Single Part, MCA, FAL) and later transfer to in service repair applications incl. consideration of standardisation & certification aspects. Definition of required work towards TRL6.

3. Major Deliverables/ Milestones and schedule (estimate)

**Type: R= Report, RM= Review Meeting, D=Data, HW=HardWare*

Deliverables			
Ref. No.	Title - Description	Type*	Due Date
Del 1	Requirement Summary	R	T0+2
Del 2	Comparison of possible welding technologies for Hard Patch Integration	R	T0+6
Del 3	comparison of possible technologies for In-Situ Repair Patch creation (Structural & Non-Structural)	R	T0+6
Del 4	TRL 3 for of Hard Patch Welding solution	R,D	T0+18
Del 5	TRL 3 for In-Situ-Repair-Patch solution	R,D	T0+24
Del 6	Report on demonstration on structural detail level (FAL/MCA) and demonstrator applicability	R, D	T0+29
Del 7	Technology comparison, applicability mapping and Roadmap to TRL6	R	T0+30

Milestones (when appropriate)			
Ref. No.	Title - Description	Type*	Due Date
Mil 1	Down selection on welding technology for hard patch repair to be investigated in Task 4 with Topic Manager	M	T0+6
Mil 2	Down selection on technology for In-Situ Repair Patch creation to be investigated in Task 5 with Topic Manager	M	T0+6
Mil 3	TRL 3 for of Hard Patch Welding solution	M	T0+18
Mil 4	TRL 3 for In-Situ-Repair-Patch solution	M	T0+24
Mil 5	Final Review for Demonstrator application readiness	M	T0+29

4. Special skills, Capabilities, Certification expected from the Applicant(s)

Essential:

- Deep knowledge on thermoplastic composite materials and chemical processes associated to thermoplastics
- Knowledge in design of primary aircraft components made of composites
- Knowledge on composite patch repair
- Design tool for composite components
- Laboratory for physical, chemical, mechanical and optical/microscopy examination of composite materials
- Laboratory for thermoplastic component prototype manufacturing for preliminary developments and repair realization

Advantageous:

- Knowledge in Health & Safety regulation and associated limitations

5. Abbreviations

FAL	Final Assembly Line
MCA	Major Component Assembly
TRL	Technology Readiness Level
NDI	Non Destructive Inspection

XVI. JTI-CS2-2020-CFP11-LPA-03-19 : Concept for Pilot State Monitoring system operation in commercial aviation

Type of action (RIA/IA/CSA):		IA	
Programme Area:		LPA	
(CS2 JTP 2015) WP Ref.:		WP 3.1	
Indicative Funding Topic Value (in k€):		800	
Topic Leader:	Honeywell International	Type of Agreement:	Implementation Agreement
Duration of the action (in Months):	24	Indicative Start Date (at the earliest)³⁸:	> Q4 2020

Topic Identification Code	Title
JTI-CS2-2020-CFP11-LPA-03-19	Concept for Pilot State Monitoring system operation in commercial aviation
Short description	
<p>The topic aims to develop Pilot State Monitoring system in the cockpit providing crucial feedback of the pilot state to yield faster decision making, reduce the probability of pilot errors and enhance the fatigue risk management. The project foresees collection of operational data, experience during nominal operations for both short and long-haul flights and the development of associated concept of operations. The concept should address envisioned use cases, identify benefits, operational constraints, risks and mitigation strategies and evaluate possible future use of the system from end users such as airlines, aircraft operators and training centres.</p>	

Links to the Clean Sky 2 Programme High-level Objectives³⁹				
This topic is located in the demonstration area:		Cockpit & Avionics		
The outcome of the project will mainly contribute to the following conceptual aircraft/air transport type as presented in the scene setter:		Advanced Long-range, Advanced Short/Medium-range, Advanced Turboprop, 90 pax, Low Sweep Business Jet		
With expected impacts related to the Programme high-level objectives:				
Reducing CO₂ emissions	Reducing NO_x emissions	Reducing Noise emissions	Improving EU Competitiveness	Improving Mobility
<input type="checkbox"/>	<input type="checkbox"/>	<input type="checkbox"/>	<input checked="" type="checkbox"/>	<input type="checkbox"/>

³⁸ The start date corresponds to actual start date with all legal documents in place.

³⁹ For further info see Chapter 1 "Introduction to the Programme Scene Setter / Objectives" with key technology themes / demonstration areas. Detailed information available in the CS2 Development Plan accessible via the Clean Sky JU Website and EC Participant Portal.

1. Background

From the regulatory perspective, pilots operate according to the established requirements regarding their medical fitness. These requirements are derived from the current medical state of the art knowledge and defined by regulatory authorities and airlines. However, despite being medically fit, pilots may experience sudden incapacitation or show impaired performance. This may be due an unforeseeable medical condition (e.g. cardiac arrest), but also due to natural changes in pilots' psychophysiological state throughout the flight (e.g. fatigue).

The detection of these natural changes that can lead to what is referred to as partial incapacitation is extremely complex and requires systematic approach. And even the detection of acute conditions like a cardiac arrest that results in total pilot incapacitation requires quite sophisticated means. If undetected and not mitigated, both total and partial incapacitation lead to compromised flight safety.

In this context, the Pilot State Monitoring system (PSM) in the cockpit provides crucial feedback of the pilot psychophysiological states that might yield faster decision making, reduce the probability of pilot errors and enhance the fatigue risk management.

The successful implementation of PSM should be beneficial to all stakeholders while mitigating key concerns related to its presence in the cockpit. The technology is being developed and validated in the frame of Clean Sky 2 programme. Having early feedback from airlines and pilots is crucial to steer future efforts in the right direction.

The key objectives of this call are:

- The installation and setup of the PSM system in the aircraft cockpit.
- Feedback from the installation/setup.
- Concept of operations of the system and the assessment of its benefits for both flight safety and operation efficiency of crews and airlines.

The specific objectives of this call are:

- Feedback on the performance of the PSM technology and the integration of the relevant sensors in the cockpit (in cooperation with the topic manager).
- Contribute to the benefit study of the PSM in operational environment.
- Gain experience from regular operations.
- Identify potential operational use cases for pilot state monitoring technology.
- Identify risks and opportunities linked to the usage of the PSM.
- Contribute to the development of mitigation strategies when a state that causes pilot incapacitation is detected.
- Data collection from PSM sensors acquired from different flights and crews.

The innovation potential of this call lies in:

- Assessment of the benefits of PSM for the fatigue risk management and identification of possibilities for operational efficiency improvements.
- Identification and assessment of operational constraints for this technology.
- The definition of PSM performance assessment measurements (e.g. accuracy, robustness, integrity, intrusiveness, sensitivity, etc.) that meet the requirements of the certification authorities.
- The validation of the concept of operations with respect to social acceptance.
- Development of methods for real operation data collection and the usage of this data for the

improvement of PSM technology.

The outcomes of this project will contribute to Biz-Jet demonstrator and will have also impact on Large Passenger and Regional Aircraft.

2. Scope of work

At the beginning, the project will focus on the definition of installation and operational requirements with respect to the future data collection campaigns. The PSM system which will be used for this project consists of a set of non-intrusive sensors (vision based, wearables and seat mounted) and a computational unit (CU; for example, a laptop with adequate storage capacity and connectivity):

- Vision based sensor set will consist of up to 3 cameras with near-infrared (NIR) illumination, connected to the CU via ethernet
- Wearable sensor is expected to be a smart-watch-like wristband, providing set of different physiological signals, connected via Bluetooth low energy (BLE)
- Seat mounted sensor will be a pad with matrix of pressure detection sensors, connected via USB; manufacturing can be adjusted according to the needs of the successful applicant

Sensors will communicate with the CU using Bluetooth and wires. Electric power can be supplied by the CU or individual power supply sources depending on requirements of the successful applicant. Apart of the set of the cameras, all the HW and SW components will be provided by topic manager.

High level scheme of system physical architecture is depicted on following scheme:

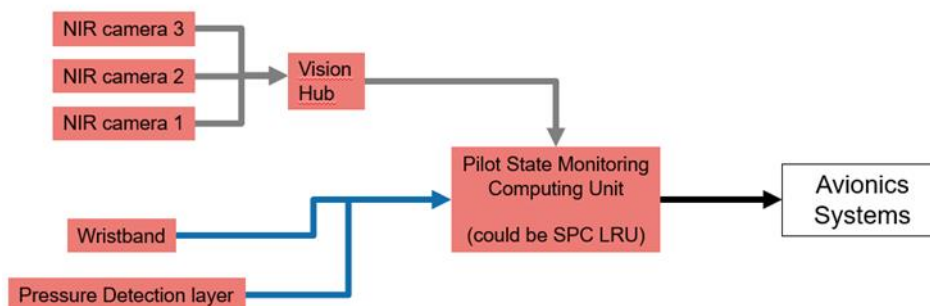

In the context of PSM, there are three levels of data defined as follows

- Raw data: Obtained from the sensors with no or minimal modifications. This data includes for example the recorded video from the camera system. Raw data that can lead to the identification of pilots will not be stored at any circumstances and will only serve as an input to the parametrization algorithms
- Parametrized data: Statistical and high-level descriptors of raw data which cannot lead to the re-identification of pilots. This data will be shared with topic manager and among members based on the Implementation agreement
- Decision level data: the output of the PSM algorithms that contains the detected state(s) in time, analogously to the parametrized data, this data cannot lead to the re-identification of pilots and thus will be shared with topic manager and among members based on the Implementation agreement

The installation will be validated by the topic manager before the real A/C installation based on the operator's target A/C configuration. The topic manager will select the representative simulator

environment for the data collection (i.e., a part task simulator, a fixed base simulator or a full motion flight simulator / test bed). The purpose of this step is to ensure that the data are not distorted by the unstable environment (e.g., turbulence, vibrations, etc.) and to identify the operational limitation of the PSM system, especially the robustness and sensitivity of the sensor generated data to the specific conditions.

The PSM system will be deployed within two phases:

- Phase 1: Data and feedback collection from the PSM sensors that will be available at the start of the project.
- Phase 2: In this phase, the PSM technology revised based on the feedbacks collected from the previous phase will be employed.

The successful applicant will contribute to the project by:

- Collecting real-operational data using the PSM system.
- Contributing to the PSM technology maturation (e.g., identification of system risks, weaknesses and concept of operations).
- Assessing the bidder's pilot social acceptance of PSM and proposing steps leading to successful integration.
- High-variability data collection, for example from long-haul and short-haul flights.
- Sharing experience and data already acquired regarding various pilot states (nice-to-have).

Here are the tasks foreseen to successfully complete the project:

Tasks		
Ref. No.	Title - Description	Due Date
Task 1	Definition of high-level specifications and requirements for system installation and setup	T0 + 3m
Task 2	Specification of methodologies for feedback and data collection	T0 + 4m
Task 3	Installation of Pilot Monitoring system into the A/C (phase 1)	T0 + 7m
Task 4	Data and feedback collection, definition of PSM concept of operations (phase 1)	T0 + 13m
Task 5	PSM usability feedback 1	T0 + 14m
Task 6	Redefinition of high-level specifications and requirements for system installation and setup for phase 2	T0 + 16m
Task 7	Installation of Pilot Monitoring system into the A/C (phase 2)	T0 + 17m
Task 8	Acceptance analysis	T0 + 18m
Task 9	Data and feedback collection, definition of PSM concept of operations (phase 2)	T0 + 22m
Task 10	Pilot Monitoring sensors and usability feedback 2	T0 + 23m
Task 11	Final evaluation / Acceptance analysis update	T0 + 24m

The Topic Manager will contribute to the tasks as follows:

- Task 1: the Topic Manager will provide detailed specifications of both SW and HW components of the PSM system and will work closely on the installation, both in light of certification and operational requirements. The final set-up and detailed specifications (e.g. number of cameras) will be agreed on through several iterations.
- Task 2: the Topic Manager will provide technical means for data/feedback upload and storage.
- Task 4: based on the first data collection campaign, the Topic Manager will work with the successful applicant on modifying/enhancing some aspects of the data collection procedure such as the position of the cameras, suggesting to have more variability in terms if flight crew or flight duration, etc.

- Task 6: based on the results of the first flight test campaign, the Topic Manager will provide updated detailed specifications of both SW and HW components of the PSM system and will work closely on the installation of the new system.
- Task 8: the Topic Manager will support the successful applicant with the statistical analysis and the evaluation of the acceptance (of the crew, the operator, etc.)
- Task 9: based on the second data collection campaign, the Topic Manager will work with the successful applicant on modifying/enhancing some aspects of the data collection procedure
- Task 11: the Topic Manager will support the successful applicant with the statistical analysis and the final evaluation of the system as a whole and its acceptance level (by the crew, the operator, etc.)

3. Major Deliverables/ Milestones and schedule (estimate)

*Types: R=Report, D=Data, HW=Hardware, RM=Review Meeting

Deliverables			
Ref. No.	Title - Description	Type*	Due Date
D1	Definition of high-level specifications and requirements for system installation/setup and methodologies for feedback and data collection	R	T0 + 4m
D2	Collected data and feedback (phase 1)	D	T0 + 13m
D3	PSM concept of operations 1	R	T0 + 16m
D4	Acceptance analysis	R	T0 + 17m
D5	Collected data and feedback (phase 2)	D	T0 + 22m
D6	PSM concept of operations 2	R	T0 + 23m
D7	Final evaluation / Acceptance analysis update	R	T0 + 24m

Milestones (when appropriate)			
Ref. No.	Title - Description	Type*	Due Date
M1	Installation of Pilot Monitoring system into the A/C (phase 1)	HW	T0 + 7m
M2	Installation of Pilot Monitoring system into the A/C (phase 2)	HW	T0 + 17m

Task	T0	T0 + 3	T0 + 6	T0 + 9	T0 + 12	T0 + 15	T0 + 18	T0 + 21	T0 + 24
High-level specs & reqts for system install & setup 1	█	█							
Spec of methodologies for feedback & data collection	█	█							
Installation of PSM into the A/C (phase 1)			◇ M1						
Data and feedback collection, PSM ConOps (phase 1)			█	█	█	█	█	█	█
PSM usability feedback 1			█	█	█	█	█	█	█
High-level specs & reqts for system install & setup 2					█	█	█	█	█
Installation of PSM into the A/C (phase 2)						◇ M2			
Acceptance analysis						█	█	█	█
Data and feedback collection, PSM ConOps (phase 2)						█	█	█	█
Pilot Monitoring sensors and usability feedback 2							█	█	█
Final evaluation / Acceptance analysis update								█	█

4. Special skills, Capabilities, Certification expected from the Applicant(s)

Essential:

- Aircraft operator operating both short-haul and long-haul flights

Advantageous:



- Operator with diversified pilot population (gender, origin, age, etc.)

5. Abbreviations

A/C	Aircraft
CS2	Clean Sky 2
PSM	Pilot State Monitoring

5. Clean Sky 2 – Regional IADP

I. JTI-CS2-2020-CFP11-REG-01-20: Aerodynamics experimental characterization and new experimental testing methodologies for distributed electrical propulsion

Type of action (RIA/IA/CSA):		RIA	
Programme Area:		REG	
(CS2 JTP 2015) WP Ref.:		WP 1.1	
Indicative Funding Topic Value (in k€):		800	
Topic Leader:	Centro Italiano Ricerca Aerospaziale	Type of Agreement:	Implementation Agreement
Duration of the action (in Months):	24	Indicative Start Date (at the earliest)⁴⁰:	> Q4 2020

Topic Identification Code	Title
JTI-CS2-2020-CFP11-REG-01-20	Aerodynamics experimental characterization and new experimental testing methodologies for distributed electrical propulsion
Short description	
Distributed electrical propulsion (DEP) can be used to improve aircraft high lift performance. If properly designed DEP allows for an increase of take-off and landing maximum lift coefficient therefore resulting on a reduction of wing surface and aircraft weight. It is proposed to develop technologies for experimental assessment of DEP aerodynamics and perform wind tunnel tests on a DEP configuration using as reference a regional 40 pax aircraft.	

Links to the Clean Sky 2 Programme High-level Objectives ⁴¹				
This topic is located in the demonstration area:		Enabling technologies		
The outcome of the project will mainly contribute to the following conceptual aircraft/air transport type as presented in the scene setter:		Advanced Turboprop		
With expected impacts related to the Programme high-level objectives:				
Reducing CO₂ emissions	Reducing NO_x emissions	Reducing Noise emissions	Improving EU Competitiveness	Improving Mobility
<input checked="" type="checkbox"/>	<input type="checkbox"/>	<input checked="" type="checkbox"/>	<input checked="" type="checkbox"/>	<input type="checkbox"/>

⁴⁰ The start date corresponds to actual start date with all legal documents in place.

⁴¹For further info see Chapter 1 “Introduction to the Programme Scene Setter / Objectives” with key technology themes / demonstration areas. Detailed information available in the CS2 Development Plan accessible via the Clean Sky JU Website and EC Participant Portal.

1. Background

REG-IADP includes a task WP1.1 addressing innovative aircraft configuration. The Regional Aircraft REG-IADP WBS is below reported.

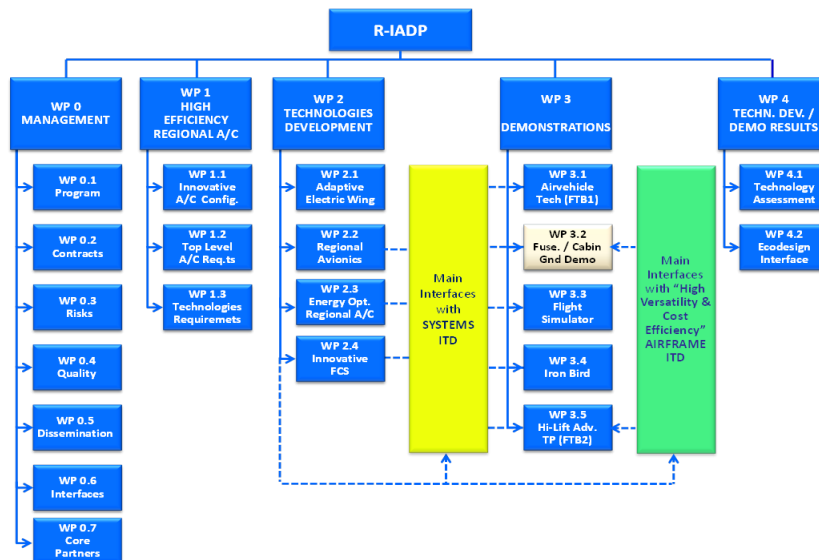

Recently within CS2 REG-IADP platform it has been decided to perform configuration studies to evaluate potential benefits that could be obtained if a 40 seats regional aircraft is equipped with electrical electrical/hybrid propulsion. It is already known that at foreseen technological level of batteries in the coming decades, benefits can be obtained only if the aircraft configuration is completely redesigned.

Distributed electrical propulsion (DEP) can be used to improve aircraft high lift performances. The slipstream of tractor propeller increase local dynamic pressure, change local angle of attack of affected wing sections and impact on local Reynolds number delaying flow separation.

In the design of new hybrid-electrical or full electrical aircraft, often DEP is proposed because it can increase maximum lift coefficient, and therefore can have a dramatic impact on aircraft design. Since wing surface is often designed for take-off and landing performance, aircraft equipped with DEP can use a considerable reduced wing surface with significant impact on wing weight and overall aircraft weight and as consequence on fuel (or electricity) consumption.

In several numerical and experimental studies, available in open literature, the aerodynamic interaction between propellers and lifting surfaces has been addressed to understand the aerodynamic interaction and serve as validation for numerical codes. However, the available studies primarily focus on cruise conditions and moderate flap deflections, with propellers which are not in close proximity. In high lift condition, with propellers in close proximity (such as in DEP configurations), there is a complex flow, in particular close to stall condition. A large number of numerical studies around these conditions requires significant computational resources and do not guarantee accurate prediction. Therefore, an experimental campaign is required to determine the relevant interaction phenomena in such condition. Additionally, the data will serve as validation for numerical codes, which subsequently can be used in design iterations.

In order to benefit from DEP, the impact of several design parameters on the system performance needs to be addressed. For example to increase high lift performance, the dynamic pressure in the propeller slipstream must be increased, but this entails smaller and smaller propellers' diameters. The use of

smaller diameters not only has an impact on propeller efficiency, but, it must be taken into account that if the propeller diameter becomes too small with respect to the airfoil chord the beneficial effect due to propeller dynamic pressure will also decrease.

Other parameters that have impact on DEP performance are the distance of propeller from the airfoil leading edge, the relative distance between propellers, and, last but not least, it must be taken into account that the flap configuration that is the optimal for a classical wing could not be the best for a DEP configuration. Additionally, the vertical position of the propeller relative to the wing chord line is expected to be an important parameter.

The experimental evaluation of such phenomena is not an easy task. Usually low speed performance of 2D airfoil and flapped airfoil in wind tunnel is measured by integrating pressure distribution measurements for lift and moment evaluation and wake rake for drag, thus, avoiding the use of balance because of potential detrimental impact of wall interference or wing tip effect that could affect 2D measurements.

This approach cannot be used for DEP since the flow is 3D even for a 2D configuration. Clearly due to propeller rotation there will be up wash or downwash at the two sides of the propeller and propeller induced velocity for each exposed wing section depends on the distance from propeller rotation axis.

The key elements that are of interest for this study are summarized below:

- Determination on which part of the wing flow separation is initiated and how this is dependent on propeller thrust coefficient.
- The effect of spacing between propeller, hence the effect of tip-vortex proximity, on the stall behaviour of the flap
- The relative position of the propeller to the wing, hence the vertical position and distance between propeller and wing leading edge.

2. Scope of work

The aim of the topic is to perform basic experimental studies to understand how DEP propeller slipstream can increase airfoil maximum lift coefficient and identify experimental techniques able to make such measurements.

It is requested to perform basic experimental studies to understand how DEP propeller slipstream can increase airfoil maximum lift coefficient and identify experimental techniques able to make such measurements.

It is proposed to test a 2D like wing, equipped with flap, and with at least three propellers installed in front of the wing.

The wind tunnel experimental test should be aimed at measurement of impact on the central wing section lift, drag and moment of:

- ✓ Propeller thrust
- ✓ Propeller tip-vortex strength
- ✓ Propeller relative position (both axial and longitudinal)
- ✓ Propeller diameters
- ✓ Flap setting

A possible test article arrangement could be similar to the one reported in the figure below, where propeller positions can be modified.

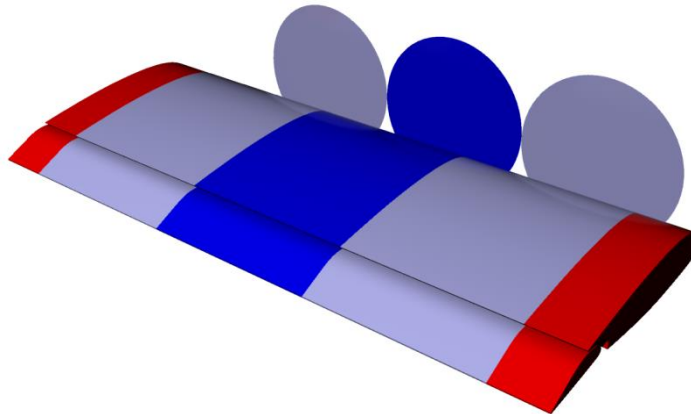

To improve physical understanding and avoid wall and/or wing tip effect, a proposed force and moment measurement is based on the use of an internal balance able to measure only forces on the test article section in the wake of the central propeller (the blue section in the picture). The applicant can of course propose an alternative solution (taking into account the requirement that for a physical understanding of the problem it is necessary to measure force and moment of the wing section in the wake of a single propeller in a DEP configuration). Surface pressure measurements should be conducted with a sufficient spanwise and chord-wise density to accurately determine where stall is initiating.

The applicant could also propose additional experimental techniques for better understanding of flow behind the propeller and the flap and identify flow separation regions. Flow field measurements downstream of the flap (e.g. PIV or total pressure measurements) and surface flow visualization (e.g. oil flow) could be required to determine the stall behaviour. Pressure sensitive paint technologies, if properly calibrated, could also be proposed as alternative or complementary measurement technique. All these measurements techniques are not mandatory but will be considered as an added value to the proposal.

Tests will be performed by using a scaled reference configuration described in the following paragraph. To reduce uncertainties in the assessment of stall it is suggested to perform the test at the higher possible Reynolds number. Nevertheless, to remain close to the indicative funding value, the applicant can propose a smaller model scale, but has to illustrate criteria used for scaling (specially on propeller/free stream speed ratio) and justification on reliability. Therefore, it is expected that, if an atmospheric wind tunnel will be proposed, to have a test article chord length not shorter than about 0.8 meter and a wind tunnel size compatible with the selected model size so that there will not be blockage effect and wall/end plate negative interaction effect specially at high incidence and flap deflected. The applicant has to:

1. Propose the best suited experimental arrangement and test article scale
2. Design and manufacture the test article
3. Provide engine and propellers
4. Perform wind tunnel test and measurement
5. Perform wind tunnel test data-analysis

The topic manager will provide full scale geometry for airfoil, flap and propellers. Scaling and wind tunnel load have to be evaluated by the applicant.

Full scale reference configuration

The reference configuration is a 40 seats regional aircraft. The actual configuration design is not yet available, but it will be provided before the project kick-off. Anyway the expected main characteristics of

the full scale configuration will be as follows:

- Chord: 2.20 m
- Flap: single slotted flap (two flap settings at about 15° and 30°, the actual values will be confirmed before the start of the project)
- Speed: 60 m/s
- Propeller thrust: 750 N, 1250 N, 1900 N
- Propeller diameters: 0.8 m, 1.3 m, 2.04 m
- Reynolds number based on chord: about 9 millions

Proposed test matrix

Tests will be performed at the higher Reynolds number compatible with the indicative funding value, and anyway at a Reynolds number not lower than about 3.5 Millions. All tests will be performed at fixed transition (transition strip). Propeller pitch angle is fixed.

The test matrix is divided in two sections, an essential and an advantageous section. The applicant has to propose at least the performance of the essential part of the test section. Including a part of the advantageous test matrix would be considered as an added value to the proposal.

ESSENTIAL TEST MATRIX							
#	FLAP deflection	Angle of Attack	Thrust	Speed m/s	Flap gap/Overlap	Wing/propeller position	Propeller diameters
1	0°	From -2 to stall	0 (no propellers, no nacelles)	60	Nominal	N/A	N/A
2	~15°	From -2 to stall	0 (no propellers, no nacelles)	60	Nominal	N/A	N/A
3	~30°	From -2 to stall	0 (no propellers, no nacelles)	60	Nominal	N/A	N/A
4	0°	From -2 to stall	T1, T2, T3	60	Nominal	Nominal	Nominal
5	15°	From -2 to stall	T1, T2, T3	60	Nominal	Nominal	Nominal
6	30°	From -2 to stall	T1, T2, T3	60	Nominal	Nominal	Nominal
7	30°	From -2 to stall	T2	40	Nominal	Nominal	Nominal
8	30°	From -2 to stall	T2	40	Nominal	Nominal	2 additional diameters
ADVANTAGEOUS TEST MATRIX							
A1	15°	From -2 to stall	T2	60	Nominal	4 positions	Nominal
A2	30°	From -2 to stall	T2	60	Nominal	4 positions	Nominal
A3	15°	From -2 to stall	T2	60	Gap/overlap sensitivity	Nominal	Nominal
A4	30°	From -2 to stall	T2	60	Gap/overlap sensitivity	Nominal	Nominal
A5	15°	From -2 to stall	T2	60	Nominal	Nominal	2 additional diameters

- ✓ T1, T2, T3 represent three different thrust levels, where T2 is the nominal value.
- ✓ Flap gap/overlap nominal position will be provided, if feasible a sensitivity studies with small variation with respect to the nominal position could be proposed
- ✓ Three sets of propellers have to be provided: the nominal one and two additional sets with a different diameter to test propeller diameter impact

A beneficial aspect would be if the propeller position relative to the wing chord would to be varied. This will affect both the dynamic pressure experienced by the main element of the wing, as well as the dynamic pressure experienced by the lower side of the flap. Additionally the propeller tip-vortex spacing will be different.

Suggested project structure

It is suggest the following work-package structure, but the applicant can propose alternative solutions provided that all proposed activities are accomplished.

Tasks		
Ref. No.	Title – Description	Due Date
WP 1	Management	T0+24
WP 2	Test set-up and test matrix definition	T0+6
WP 3	Wind tunnel model design and manufacturing	T0+18
WP 4	Wind tunnel test performance	T0+20
WP 5	Wind tunnel test data analysis	T0+24

WP 1: Management

The applicant has to set-up all classical project management structure and will be required to organize periodic meetings (also by TELECON) with topic manager for project monitoring.

WP 2: Test set-up and test matrix

A test set-up and model scale must be proposed such that it is able to provide the most reliable experimental data-set and to provide forces acting on the wing central section (the wing section immersed in the central propeller wake).

The following parameters have to be addressed:

- a. Two free stream speed
- b. Three propeller thrust levels test
- c. Four propeller/wing relative position
- d. Three propeller diameters
- e. Two flap settings (with possible gap/overlap experimental optimization at least for one single propeller power setting)
- f. A drag increase device for landing configuration
- g. Angle of attack up to stall plus 4° degrees

To evaluate propeller installation effects, in addition to propeller-on tests, tests have to be performed also with propeller-off configuration and nacelle off configuration (only wing, that is, without nacelle and without propellers).

Detailed test conditions are reported in the test matrix paragraph. At least essential tests have to be proposed.

Since it is necessary to separate forces acting on the airfoil by forces generated by the propeller, a proposed solution is to use a six-component internal balance to determine the propeller forces by connecting the balance to the motor. Alternative proposal could be suggested, for example, the use of a

separate support for the propeller and the airfoil provided that aerodynamics interference of supports is minimized. This last solution has the beneficial effect that allows for testing different relative propeller/wing positions, but has the drawback that propeller/wing relative positions must be carefully measured and that the propeller will not change the pitch while the airfoil angle of attack is changed.

The following measurements/instrumentation is expected:

- Total forces and moments on the model measured by internal balance (Lift, Drag, Pitching) on the model central part;
- At least 100 steady pressure taps on the model central section in two lines at propeller side in the propeller wake;
- Propeller forces (Thrust and torque) on the central propeller measured with a maximum resolution of 1 % of the mean thrust;
- Propeller rotation speed, measured with a resolution of maximum 0.1% of the set point.;
- Propeller shaft power

Sufficient repeat measurements should be conducted to quantify error bars in the delivered data.

WP 3: Wind tunnel model design and manufacturing

The applicant will be responsible to design and manufacture the model and provide all required test instrumentation. The test article should have a chord not lower than about 0.8 meter (about 1 to 2.5 scale). Bigger scale model could be proposed if compatible with the indicative funding value. The applicant should demonstrate that at proposed scale enough power to correctly scale the propellers can be provided, that at high angle of attack and flap deflected blockage effect and test article wall and/or end plate interference effect are not relevant.

To correctly scale the propeller thrust it is relevant to remember that the main parameter to respect is the ratio between propeller slipstream speed and free stream speed. Therefore, since propeller slipstream depends on propeller load ($T/A\rho$), the propeller thrust for the test article can be scaled with the square of propeller diameter (the square of the model scale factor). If propeller thrust scaling is not fully accomplished suggestions and methodologies for full scale extrapolation should be provided.

The following requirements are expected to be satisfied:

- ✓ Propeller blade pitch (fixed pitch) set with an accuracy of 0.05 degree
- ✓ Surface roughness between 0.3 and 0.4 micro-meter
- ✓ Angle of attack of the model within 0.02 degree

WP 4: Wind tunnel test performance

The applicant will be responsible for test execution and to provide test engineering.

WP 5: Wind tunnel test data-analysis

The applicant will be responsible of test data analysis. Raw data processing and wind tunnel correction compliance with wind tunnel expertise have to be provided.

The applicant has also to provide forces and moment acting on the wing central part without propeller forces.

Therefore the following separated data-set have to be provided for each test conditions:

- Propeller forces, moment and power
- Central wing forces and moment
- Flap moment and forces (only for deflected flap configuration).

3. Major Deliverables/ Milestones and schedule (estimate)

*Type: R=Report, D=Data, HW=Hardware

Deliverables			
Ref. No.	Title - Description	Type	Due Date
Del 1.1	Technical Progress report	R	T0+12
Del 1.2	Final Technical Progress	R	T024
Del 2.1	Experimental set-up definition	R	T0+6
Del 2.2	Wind tunnel test matrix and test requirements	R	T0+6
Del 3.1	Test article design	R, D	T0+9
Del 3.2	Test article manufacturing	H	T0+18
Del 4.1	Preliminary Test report (raw data)	R, D	T0+20
Del 5.1	Final Test report (corrected data)	R, D	T0+24

Milestones			
Ref. No.	Title – Description	Type	Due Date
M1 (WP2)	Experimental set-up definition	R	T0+6
M2 (WP3)	Test article design	R	T0+9
M3 (WP3)	Test article manufacturing	H	T0+18
M4 (WP4)	Performance of wind tunnel tests	D	T0+20
M5 (WP5)	Test report	R	T0+24

4. Special skills, Capabilities, Certification expected from the Applicant(s)

Essential:

- Consolidated experience in wind tunnel test technical management.
- Knowledge of wind tunnel test measurement techniques.
- Experience in Wind tunnel test activities, data analysis and reporting.

Advantageous:

- Managing capabilities for European research projects.
- Past expertise in propeller wind tunnel test
- Expertise in PIV/PSP measurement techniques

5. Abbreviations

Ap	Propeller disk area
A/C	Aircraft
CFD	Computational Fluid Dynamics
CL	Lift Coefficient
CLmax	Maximum lift coefficient
DEP	Distributed Electrical Position
LE	Leading edge
PIV	Particle Image Velocimetry
PSP	Pressure Sensitive Paint
T	Propeller Thrust
TE	Trailing edge
TP	Turboprop



6. Clean Sky 2 – Airframe ITD

I. JTI-CS2-2020-CFP11-AIR-01-46: Evaluation of NDT Techniques for Assessment of Critical Process and Manufacturing Related Flaws and Defects for a Ti-alloy

Type of action (RIA/IA/CSA):		RIA	
Programme Area:		AIR	
(CS2 JTP 2015) WP Ref.:		WP A-3.3	
Indicative Funding Topic Value (in k€):		550	
Topic Leader:	SAAB AB	Type of Agreement:	Implementation Agreement
Duration of the action (in Months):	24	Indicative Start Date (at the earliest)⁴²:	> Q4 2020

Topic Identification Code	Title
JTI-CS2-2020-CFP11-AIR-01-46	Evaluation of NDT Techniques for Assessment of Critical Process and Manufacturing Related Flaws and Defects for a Ti-alloy
Short description	
One of the major challenges to be solved before additive manufacturing (AM) can be fully utilized in aerospace applications is understanding the effect of process related critical flaws and defects on material and mechanical properties in AM parts. Therefore, evaluation of reliable Non-Destructive Testing and Analysis (NDT/NDA) techniques for precisely assessing eventual defects and their criticality in AM parts needs to be performed. The activities to be performed are test design, manufacturing, testing, characterization, modelling, and qualification of AM-parts with suitable NDT techniques.	

Links to the Clean Sky 2 Programme High-level Objectives ⁴³				
This topic is located in the demonstration area:		Advanced Manufacturing		
The outcome of the project will mainly contribute to the following conceptual aircraft/air transport type as presented in the scene setter:		Advanced Short/Medium-range, Advanced Long-range		
With expected impacts related to the Programme high-level objectives:				
Reducing CO₂ emissions	Reducing NO_x emissions	Reducing Noise emissions	Improving EU Competitiveness	Improving Mobility
<input checked="" type="checkbox"/>	<input type="checkbox"/>	<input type="checkbox"/>	<input checked="" type="checkbox"/>	<input type="checkbox"/>

⁴² The start date corresponds to actual start date with all legal documents in place.

⁴³ For further info see Chapter 1 “Introduction to the Programme Scene Setter / Objectives” with key technology themes / demonstration areas. Detailed information available in the CS2 Development Plan accessible via the Clean Sky JU Website and EC Participant Portal.

1. Background

This topic is part of the Airframe High Performance and Energy Efficiency (Activity Line A) line and is linked to the Work Package A-3.3: Innovative shapes & structures, where the work on the design concept for innovative aircraft door structure and its integration is being performed. The topic is one of the key research activities which will ultimately result in introduction of innovative technologies for more efficient airframes in regard to weight, cost and environmental impact as well as manufacturing process.

Moveable, load bearing and flight critical aircraft structures such as cargo doors can be fairly complex products and a typical cargo door can consist of hundreds of individual parts, a number of relatively large (>1kg) metallic parts which can be machined, forged or in some cases cast. Additive manufacturing (AM) has shown great promise within the aerospace industry for the manufacture of such parts, offering potential benefits in terms of weight, design/functionality, lead time and cost/manufacturability. Within Work Package A-3.3, newly developed tools will be used to evaluate current/typical cargo door parts in terms of their manufacturability, cost and design/weight. The parts identified as candidates for AM will be those showing the greatest potential for cost and weight reduction.

Additive manufacturing (AM) is a technology by which physical objects are built by a layer-by-layer approach and is widely acknowledged as an enabler for revolutionising the traditional manufacturing. It replaces long-established production methods like casting and machining allowing essentially arbitrary geometric shapes to be produced. This is very attractive to the aerospace industry as parts could be designed with reduced weight and improved performance contributing to reduce fuel consumption, increase pay-load and extend flight range. However, there are still technology gaps such as material property control, correlation between process and structural properties, effect of defects, quality control, etc. that prevent reliable and safe use of AM technology.

The material and mechanical properties of AM parts differ substantially from the properties of the same parts produced by conventional methods as AM parts suffer from process and manufacturing related defects, and rough as-built surfaces. In particular, fatigue properties are affected by processing flaws for example porosity and lack-of-fusion defects that act as internal stress concentrators having a detrimental effect on the fatigue life. For this purpose, a damage tolerance assessment needs to be performed for AM parts in commercial aircraft applications because AM parts have to be designed so that functional and safety requirements for operation are met. However, this requires that there are proved Non-Destructive Testing (NDT) methods that are capable of finding different defects in AM parts. NDT is one of the most common method used of inspecting convectional manufactured parts for structural integrity, however, complex geometries and process induced defects associated with AM pose a challenge to the conventional NDT methods.

As there is currently lack of reliable NDT techniques for precisely assessing eventual internal and surface defects (e.g. trapped powder, pores, voids, inclusions, lack of fusion, cracks, surface roughness) and their criticality, there is a need for evaluation of defect detection in AM parts using various NDT methods and their applicability (e.g. detectability, classification of errors in correlations with the NDT measuring time, resolution and costs, etc.). The objective of this work is therefore quantitative assessment and applicability of NDT methods such as ultrasonic inspection with immersion, eddy current, 2D X-ray, etc. to AM parts in order to realize benefits offered by AM. The project will cover manufacturing of test pieces made of Ti64 Grade 5 alloy by laser powder bed fusion (L-PBF) AM process, characterization of AM parts by various NDT methods, mechanical testing, fractography and micrography work, modelling with prediction and validation.

2. Scope of work

The project aims to use traditional aerospace NDT techniques to characterize inner and outer defects associated with additive manufacturing and processing, understanding effect of the defects on fatigue performance, determining reliability of detection in order to establish acceptance limits and establishing a correlation between NDT, processing and material/mechanical properties with recommendations. Consequently, the following areas are addressed:

- Manufacturing and machining of test specimens by using laser powder bed fusion (L-PBF) AM technique (as-built) as well as conventional manufacturing technique (milled).
- Characterisation of inner and outer defects in terms of their geometry, size and position by applying NDT methods before and after testing.
- Mechanical testing to understand effect of defects on fatigue life (both crack initiation and crack propagation) and to determine probability of detection of a critical defect size.
- Material characterisation including residual stresses, grain size, anisotropy, surface roughness, etc. to determine damage mechanisms and link the mechanical properties to the AM processing as well as NDT.
- Modelling of defects and fatigue life prediction including prediction uncertainties.
- Final assessment with lesson learnt and conclusions.

It is proposed to organise the activities in the following tasks:

Tasks		
<i>Ref. No.</i>	<i>Title - Description</i>	<i>Due Date</i>
1	Project management	T0+24
2	Experimental set up and manufacturing of test pieces	T0+09
3	Characterization of defects by various NDT methods	T0+18
4	Mechanical testing with evaluation of material properties	T0+22
5	Modelling of defects and fatigue life prediction	T0+24
6	Assessment and reporting	T0+24

Task 1: Project management

The main activities will consist in the coordination of the project, organization of the project meetings, communication towards the Topic Manager and reporting of the project results. Regular project progress meetings with the Topic Manager will be set up during the project duration.

Task 2: Experimental set up and manufacturing of test pieces

This task covers experimental set up and manufacturing of AM test specimens by L-PBF AM technique. The experimental set up defines test plans for the mechanical testing including test variables, and the characterization work. Along with the experimental set up, Task 2 will manufacture and deliver test specimens produced with real defects for Tasks 3 and 4, see Figure 1. The AM test pieces will be manufactured in a single machine with identical process parameters using a commercially available laser additive manufacturing system. Further, the specimens will be built in upright standing position (90°) with manufacturing layers being perpendicularly orientated to the loading direction. One batch of the specimens will be kept in untreated surface condition while a 2nd batch will be milled with an average surface roughness of Ra=3.2µm. For relaxation of residual stresses, a post-process heat treatment will be applied. Measurement of surface roughness of all specimens is to be performed after manufacturing.

A dedicated budget from overall project's budget shall be used for material acquisition.

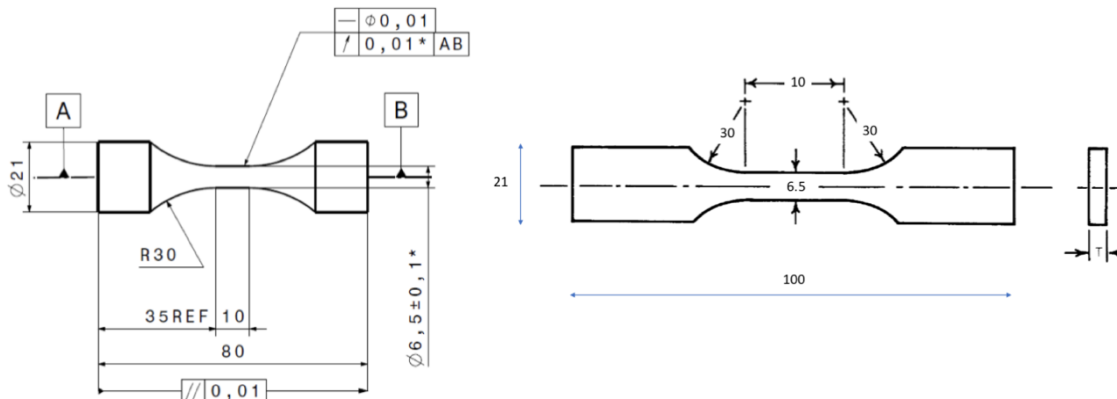

Figure 1: Fatigue test specimen design and dimensions

Task 3: Characterization of defects by various NDT methods

The activity will begin with the review of the different NDT methods and selection of the most promising NDT methods for detection of both internal and external defects in regard to specimen designs and material used. The NDT techniques applicable for the work include optical/visual inspection techniques, ultrasonic techniques, electromagnetic and eddy current techniques, X-ray radiography and CT (Computer Tomography), thermography, etc. In order to locate and understand behaviour of defects, the relevant NDT techniques will be applied on the specimens from Task 2 prior and after the mechanical testing. In addition, a number of fatigue tests will be interrupted to allow for crack assessment and evaluation.

Task 4: Mechanical testing with evaluation of material properties

Mechanical testing with the AM specimens produced from Task 2 will be conducted with the aim to understand damage and failure modes from internal and surface defects. For this, an extensive characterization of the tested specimens will be also undertaken. The testing and characterization work necessary to understand the behaviour and fracture of AM parts from various defects should include the following:

- Fatigue crack initiation,
- Fatigue crack propagation,
- Residuals stress measurements,
- Surface roughness measurements, and
- Fractography and micrography work.

Task 5: Modelling of defects and fatigue life prediction

In this task, industry relevant fatigue life prediction methods will be developed with respect to the quantified defects in the above evaluated specimens from Tasks 3 and 4. Based on the performed NDT in Task 3 the internal defect size and density will play a significant role in the fatigue life, and these need to be accounted for in the fatigue life prediction models developed. Thus, to assess these damaging defects in an AM specimen, a statistical approach can be used to evaluate the crack initiation and subsequent growth, or evaluating the defects based on a microcrack coalescence concept. Furthermore, surface induced crack initiation and growth need to be accounted for with respect to the surface roughness measurements to be performed in Task 4.

Task 6: Assessment and reporting

The final conclusions will be reviewed and reported in this task, which includes lessons learnt and recommendations for further work towards greater application of NDT within AM in industry.

3. Major Deliverables/ Milestones and schedule (estimate)

*Type: R=Report, D=Data, HW=Hardware

Deliverables			
Ref. No.	Title - Description	Type*	Due Date
D1	Consortium and implementation agreement in place	R	T0+1
D2	Test and characterization matrix established	R	T0+3
D3	Delivery of AM test pieces	HW	T0+9
D4	Report regarding detection of internal and external defects with different NDT methods	R	T0+18
D5	Preliminary failure and damage mechanisms investigation to inform modelling work	R	T0+18
D6	Final report regarding effect of defects on fatigue life and potential for early detection in AM parts	R	T0+22
D7	Final report regarding modelling and life prediction of defects in AM parts	R	T0+24
D8	Lesson learnt with recommendations	R	T0+24

Milestones (when appropriate)			
Ref. No.	Title - Description	Type*	Due Date
M1	Test and characterization plan approval	R	T0+3
M2	NDT methods selected	R	T0+3
M3	Delivery of test and characterization specimens	HW	T0+9
M4	Mid-term project review	R	T0+12
M5	Review of fatigue test results and modelling work	R	T0+16
M6	Completion of planned NDT testing	R	T0+18
M7	Completion of planned mechanical testing	R	T0+22
M8	Final project review	R	T0+24
M9	Guide for the developed models	R	T0+24

Task no	T0+1	T0+2	T0+3	T0+4	T0+5	T0+6	T0+7	T0+8	T0+9	T0+10	T0+11	T0+12
Task 1	D1											M4
Task 2			D2 M1						D3 M3			
Task 3			M2									
Task 4												
Task 5												
Task 6												

Task no	T0+13	T0+14	T0+15	T0+16	T0+17	T0+18	T0+19	T0+20	T0+21	T0+22	T0+23	T0+24
Task 1												M8
Task 2												
Task 3						D4 M6						
Task 4						D5				D6 M7		
Task 5				M5								D7 M9
Task 6												D8

4. Special skills, Capabilities, Certification expected from the Applicant(s)

Essential:

- Capability to manufacture AM parts by L-PBF AM process.
- Capability to perform mechanical testing and material characterization of metal AM material including tensile testing, fatigue crack initiation and crack propagation testing.
- Capability to perform NDT analysis by using, for example, ultrasonic inspection with immersion techniques, eddy current, 2D X-ray, etc., for detection of both internal and external defects as a result of processing and manufacturing.
- Capability to perform surface roughness and residual stress measurements.
- Sample preparation and surface polishing facilities.
- Microstructural investigation facilities including light microscopy and SEM+EBSD.
- Capability to perform inspections with optical techniques and scanning electron microscopy.
- Experience in deformation and damage mechanisms of metallic materials and structural strength modelling.
- Capability to perform simulations using industry relevant models for fatigue life predictions.
- Expertise in fatigue life prediction analyses.
- Expertise in FE-analyses.

Advantageous:

- Experience in research on additive manufactured Ti-alloys by using different AM techniques.
- Experience in collaborating with aeronautical companies and in associated research and technology programmes such as Clean Sky.
- Experience in effective and efficient project management including working with industry.

5. Abbreviations

AM	Additive manufacturing
NDT	Non-destructive testing
L-PBF	Laser powder bed fusion process
SEM	Scanning electron microscopy
Ti	Titanium
FEA	Finite element analysis
2D	Two-dimensional
EBSD	Electron backscatter diffraction

II. JTI-CS2-2020-CFP11-AIR-01-47: Additive Manufacturing demonstration on test article for a trailing edge application with a sliding pad concept

Type of action (RIA/IA/CSA):		IA	
Programme Area:		AIR	
(CS2 JTP 2015) WP Ref.:		WP A-4.1.2	
Indicative Funding Topic Value (in k€):		500	
Topic Leader:	ASCO Industries	Type of Agreement:	Implementation Agreement
Duration of the action (in Months):	26	Indicative Start Date (at the earliest)⁴⁴:	> Q4 2020

Topic Identification Code	Title
JTI-CS2-2020-CFP11-AIR-01-46	Additive Manufacturing demonstration on test article for a trailing edge application with a sliding pad concept
Short description	
The aim of this topic is to develop an additive manufacturing approach using Wire Direct Energy Deposition for a flap track structure, supported by simulations to compensate potential deformation after printing. Several test articles and coupons will be printed and tested: DI and NDI are requested, as also geometrical and metallurgical investigations to confirm material performance. In addition, a sliding pad principle will be designed and manufactured to replace rollers attached to the carriage in the flap track assembly in order to reduce the operational maintenance efforts.	

Links to the Clean Sky 2 Programme High-level Objectives ⁴⁵				
This topic is located in the demonstration area:		Enabling Technologies		
The outcome of the project will mainly contribute to the following conceptual aircraft/air transport type as presented in the scene setter:		Low Sweep Business Jet		
With expected impacts related to the Programme high-level objectives:				
Reducing CO₂ emissions	Reducing NO_x emissions	Reducing Noise emissions	Improving EU Competitiveness	Improving Mobility
<input checked="" type="checkbox"/>	<input type="checkbox"/>	<input type="checkbox"/>	<input checked="" type="checkbox"/>	<input type="checkbox"/>

⁴⁴ The start date corresponds to actual start date with all legal documents in place.

⁴⁵For further info see Chapter 1 “Introduction to the Programme Scene Setter / Objectives” with key technology themes / demonstration areas. Detailed information available in the CS2 Development Plan accessible via the Clean Sky JU Website and EC Participant Portal.

1. Background

One of the key objectives of the Clean Sky 2 programme is to minimize the impact of aviation on the environment through key innovation. A way to achieve this is to increase the effectiveness and enlarge the functionality of the control surfaces of an aircraft. This may lead to a performance increase as it allows the reduction of the structural weight, which has a direct result on the fuel burn and emission of the aircraft. The objective of the Airframe ITD is to identify promising innovative technology building blocks and to mature this technology to TRL 4 or 5. Within Technology Stream A-4 “Novel Control”, several innovative movable concepts are developed with as primary aim to increase its effectiveness.

A way to increase the functionality of the control surfaces of an aircraft is to add a second degree of freedom to an existing panel. Figure 1 below shows an impression of flap support structure with external actuation mounted underneath the wing of a HSBJ. The second actuator is attached to and moves with the carriage, it could allow the combination of aileron and high lift functions in one flap body.

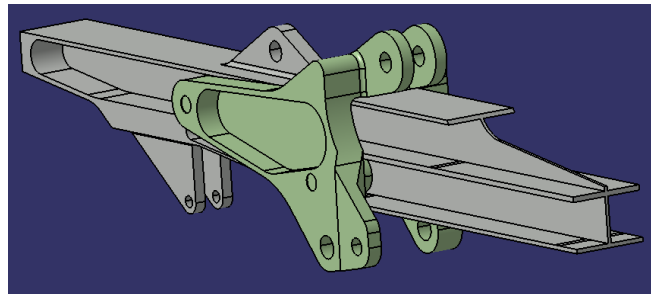

Figure 1.: Flap support concept - roller track and carriage

The topic manager is interested in

- A. Wire Direct Energy Deposition (W-DED) technology for printing the flap track structure
- B. Sliding pad principle to replace the rollers in the carriage assembly that moves along the roller track

The W-DED technology is an alternative to the traditional forging product used to produce the flap track structure. Figure 2 shows some examples of aerospace components produced with W-DED. Compared to traditional manufacturing, this technology allows for a more efficient material usage, reduces production waste and time-to-market. Nevertheless, high investment cost on equipment, building allowables and considerable deformation after printing are challenges that still need to be addressed.



Figure 2. (LEFT) Study case for Airbus upper rear spar component in Ti6Al4V printed using Sciaky W-DED EBAM [1]. **(RIGHT)** First FAA-certified Ti6Al4V Structural component galley bracket for Boeing 787 Dreamliner printed using Norsk Titanium W-DED WAAM [2].

[1] <http://www.envirotrec.ca/2017/01/16/airbus-to-3-d-print-airframe-structures/>

[2] <https://www.norsktitanium.com/media/press/norsk-titanium-delivers-first-faa-certified-additive-manufactured-ti64-structural-aviation-components>

A typical flap support, as shown in figure 1, relies on 2 sets of 4 rollers to transfer flight/ground and lateral loads from the flap panel via the roller track into the wingbox. These rollers are part of the carriage assembly and need to be re-greased at regular intervals during the life of an aircraft. If the rollers could be replaced with sliding or rubbing pads, that require no maintenance (other than inspection), this would reduce the direct maintenance cost with a non-negligible amount.

2. Scope of work

The topic is organised in two main work packages:

- A. Printing, testing and validation of a flap track structure manufactured via W-DED
- B. Design, manufacturing and testing of sliding pads

A. Printing, testing and validation of a flap track structure manufactured via Wire Direct Energy Deposition (W-DED)

This work package targets the printing of a functional structural Aerospace component in Titanium alloy (Ti6Al4V) using one of the W-DED techniques. The selected component would have an envelope size of around 1000-1500 x 200-400 x 100 mm³ (XYZ), which is expected to generate considerable deformation during printing, and has certain design features that must be cautiously addressed. The quality must be confirmed of the printed Ti6Al4V structural component with respect to the conventional manufacturing process. For that, the investigation will include the printing of several components, and the evaluation of the microstructure, the mechanical properties, and the surface and core qualities of the printed and the post-processed component (heat treated and machined) against those of the conventional part (forging used as baseline). Additionally, samples will be foreseen for crosschecking against existing requirements specified for W-DED.

B. Design, manufacturing and testing of sliding pads

The applicant will investigate design solutions to replace flight and/or side rollers with sliding (or rubbing) pads, while respecting the requirements provided by the Topic Manager. Based on the outcome, the applicant will manufacture and test parts, using a representative roller track (the counterpart).

The different test articles with sliding pads are delivered to the topic manager for further testing which is not part of this call.

It is proposed to organise the activities in the following tasks:

Tasks		
<i>Ref. No.</i>	<i>Title - Description</i>	<i>Due Date</i>
A-1	Printing simulation and trials	T0 + 06
A-2	Post-printing actions and evaluation of the printing process	T0 + 20
A-3	Validation of the finishing component	T0 + 24
B-1	Design and manufacture sliding pad	T0 + 12
B-2	Validate sliding pad wear	T0 + 18

Task A-1: Printing simulation and trials

The applicant prints several near net shapes (NNS) of the Ti6Al4V structural component to optimize material utilization, and by defining an additive manufacturing strategy using simulations that minimizes or practically eliminates the distortions that may be generated during the process. The NNS shall then be heat treated. During the build, in this same base plate, coupons need to be foreseen for extracting

mechanical testing coupons and samples for microstructure analysis. The amount of coupons will be defined according to a test plan that is delivered from task A-2. All NNS not considered for task A-2 are to be delivered to the Topic Manager after finishing task A-1.

Task A-2: Post-printing actions and evaluation of the printing process

The applicant is responsible to finish the NNS to the final component shape and perform the necessary dimensional control and quality (FPI) assessment. A detailed study on the deformation with and without heat treatment and link to the simulation in Task A-1 is requested. An additional verification step on the remaining residual stresses is requested. All finished test articles are to be delivered to the Topic Manager to allow testing in the full assembly (not scope of this CfP).

The applicant will also compile a test plan, supported by the Topic Manager:

- Manufacture and prepare the necessary coupons to perform all tests, which includes tensile, shear, fracture toughness, crack propagation and fatigue tests
- The NSS and finished components are inspected for internal defects using UT
- Detailed evaluation of the microstructure (as-printed and heat treated) is requested

Task A-3: Validation of the finished component

The applicant shall perform a demonstration test of the finished components. Given the outcome of the test results, the best combination of printing parameters vs deformation, heat treatment & finishing will be selected to print the final test articles for this validation experiment. An Engineering Test Specification (ETS) will be provided by the Topic Manager, which is a document that contains all the requirements and criteria for the test. The applicant will design and manufacture the testing tooling before starting the construction and assembly, which shall also be validated. All tests are then performed by the applicant. The final deliverable is an Engineering Testing Report (ETR), including not only the result from the test, but also a verification of integrity of the component via NDI (UT or Eddy current, to be selected according to the criteria defined in the ETS).

Task B-1: Design and manufacturing sliding pad

As part of this task, the applicant will design and manufacture sliding pads to replace the 4 flight and/or 4 side rollers. The task is supported by the Topic Manager, who will provide the applicant with detailed input, such as design envelope, counterpart, loads, wear limits and number of flight cycles. The applicant is responsible for the detailed design of the pad, including geometry, material definition and requirements for the counterpart. Special attention shall be given to the fact that the friction load generated by the sliding pad should be comparable or less than a conventional greased track roller. The applicant is responsible for the manufacturing of the sliding pads in close collaboration with the Topic Manager.

Task B-2: Validate sliding pad wear

In order to demonstrate that the sliding pads do not need to be replaced during the life of the aircraft, the applicant shall propose a development test and ensure the wear remains within limits (typically 0.3 mm for such components). An Engineering Test Specification (ETS) will be created by the applicant based on the detailed input provided in task B-1 and evaluated together with the Topic Manager. The Topic Manager will also witness the test and support the applicant in case of unexpected events.

3. Major Deliverables/ Milestones and schedule (estimate)

*Type: R=Report, D=Data, HW=Hardware

Deliverables			
Ref. No.	Title - Description	Type*	Due Date
D-A-1	Development & testing plan	R	T0 + 02
D-A-2	First near-net shape test articles printed	HW	T0 + 06
D-A-3	Finished printed test article delivered	HW	T0 + 12
D-A-4	Dimensional control report	R	T0 + 11
D-A-5	Metallographic investigation & comparison	R	T0 + 16
D-A-6	Non-destructive testing report	R	T0 + 17
D-A-7	Destructive testing report	R	T0 + 20
D-A-8	Validation report & review	R	T0 + 24
D-B-1	Development & testing plan	R	T0 + 02
D-B-2	Sliding pad detailed drawing	D	T0 + 08
D-B-3	Manufactured parts	HW	T0 + 12
D-B-4	Test result report	R	T0 + 18

Milestones (when appropriate)			
Ref. No.	Title - Description	Type*	Due Date
M-A-B-1	Kick-off meeting	R	T0 + 01
M-A-B-2	Development & testing plan review	R	T0 + 02
M-A-1	Design & printing strategy review	R	T0 + 07
M-A-2	Test Results Review	D	T0 + 20
M-A-3	Validation test evaluation	R	T0 + 24
M-B-1	Sliding pad design review	R	T0 + 06
M-B-2	Test plan review	R	T0 + 14
M-B-3	Test result review	D	T0 + 18

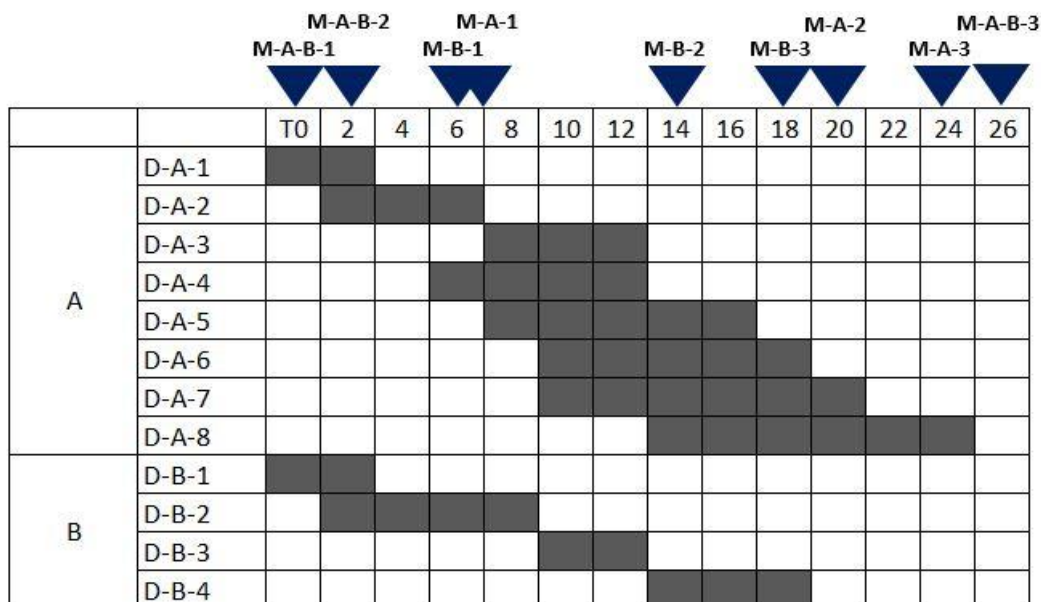

4. **Special skills, Capabilities, Certification expected from the Applicant(s)**

Essential:

- Sound technical knowledge in the field of asked contributions;
- Evidence to be able to cope with the required high level of adequate resources in qualified personnel, required tools and equipment. Experience in aeronautic industry is recommended;
- Experience in management, coordination, and development of testing methods and the execution of a test program;
- To have workshop facilities (test equipment and manufacturing facilities) in line with the proposed deliverables and associated activities;
- Capability to manufacture additive manufactured components produced via one of the W-DED techniques;
- Experience in the development and testing of wear surfaces in aerospace or other industries;
- Solid knowledge in the manufacturing of wear surfaces
- Experience with and access to CAD software CATIA V5® (or a compatible software)

Advantageous:

- Experience in the non-destructive inspection, and specifically on additive manufacturing parts.
- Experience on microstructure characterization of titanium alloys.

5. **Abbreviations**

W-DED	Wire Direct Energy Deposition	NDI	Non Destructive Inspection
NNS	Near-Net-Shape	UT	Ultrasonic Inspection
EBAM	Electron Beam Additive Manufacturing	DI	Destructive Inspection
WAAM	Wire Arc Additive Manufacturing		
WP	Work Package		

III. JTI-CS2-2020-CFP11-AIR-03-10: Innovative light metallic and thermoplastic airframe section full scale testing

Type of action (RIA/IA/CSA):		IA	
Programme Area:		AIR	
(CS2 JTP 2015) WP Ref.:		WP C-2	
Indicative Funding Topic Value (in k€):		1300	
Topic Leader:	Hellenic Aerospace Industries	Type of Agreement:	Implementation Agreement
Duration of the action (in Months):	24	Indicative Start Date (at the earliest)⁴⁶:	> Q4 2020

Topic Identification Code	Title
JTI-CS2-2020-CFP11-AIR-03-10	Innovative light metallic and thermoplastic airframe section full scale testing
Short description	
<p>The topic deals with the full scale testing of three airframe section demonstrators: two metallic fuselage panels incorporating newly developed Al-Li Alloys and related manufacturing methods, welding and chrome free surface treatments technologies, and a thermoplastic fuselage panel with an integrated stiffening structure.</p> <p>The main activities concern the preparation of test adaptation hardware, instrumentation and data acquisition and test of the two fuselage structures. Deformation measurements by novel techniques are required in order to provide accurate onset prediction of failure. Test prediction stress analysis and data processing and evaluation shall be performed.</p>	

Links to the Clean Sky 2 Programme High-level Objectives ⁴⁷				
This topic is located in the demonstration area:			Eco-Design	
The outcome of the project will mainly contribute to the following conceptual aircraft/air transport type as presented in the scene setter:			Low Sweep Business Jet	
With expected impacts related to the Programme high-level objectives:				
Reducing CO ₂ emissions	Reducing NO _x emissions	Reducing Noise emissions	Improving EU Competitiveness	Improving Mobility
<input checked="" type="checkbox"/>	<input type="checkbox"/>	<input type="checkbox"/>	<input checked="" type="checkbox"/>	<input type="checkbox"/>

⁴⁶ The start date corresponds to actual start date with all legal documents in place.

⁴⁷For further info see Chapter 1 “Introduction to the Programme Scene Setter / Objectives” with key technology themes / demonstration areas. Detailed information available in the CS2 Development Plan accessible via the Clean Sky JU Website and EC Participant Portal.

1. Background

This topic is part of AIRFRAME ITD, Activity Line C (Eco-Design), WP C-2.3 (Eco-Design Demonstrator), and will support activities of ecoTECH Core Partner project.

Within WP C-2.3, the topic manager will develop new surface treatments (Chrome free anodizing, sol gel and primers), selective stripping, manufacturing (high speed machining-pocketing) and joining (Laser Beam Welding and Friction Stir Welding) for newly developed Al-Li alloys (AA2198, AA2060, AA2099, AA2196, etc.) technologies. All these technologies are expected to offer better performance (improved mechanical properties and better corrosion resistance) in combination with environmental benefits such as elimination of hexavalent Chromium, energy reduction, out of bath and dry technologies reducing toxic and water waste, improved corrosion resistance as well as improved recyclability.

The Metallic and Surface Treatments technology stream is one of the main streams in ecoTECH project and aims to develop new environmentally friendly and efficient surface treatments, innovative joining technologies and investigate current and new manufacturing technologies for 4th generation Al-Li alloys. Another major advantage of metal joining technologies is the weight reduction due to the elimination of the overlap required for riveting sheet metal parts. Also production time and complexity is reduced as well as the possibility of accidental damage during assembly.

The thermoplastics stream is another ecoTECH stream where light weighted structures and low energy processes are evaluated. By integrating the stiffening structure into the skin surface it is possible to manufacture skin and stiffening structure in one process step. Therefore energy consumption will be reduced as additional manufacturing and assembling of the stiffeners is not needed.

2. Scope of work

The scope of the project is the demonstration of the structural integrity of representative aircraft fuselage panels by static and fatigue testing. In overall static failure test for one metallic and one thermoplastic panel shall be performed as well as fatigue failure test of a second metallic panel identical to the first one. For this second panel standard sized defects will be introduced at prescribed locations in order to investigate the crack initiation and propagation behaviour of the novel alloys and joining methods.

Proving of performance of welded joints in static as well as variable loads that are representative of the aircraft mission profile is of major importance for the airworthiness approval of novel structural designs. Demonstration of the improved fatigue resistance properties of Al-Li alloys when processed with novel joining methods for a real structural component is also an important target of the test, especially for the areas where residual stresses exist, as the welded joints. Additionally, improvement of defect growth rates for Al-Li alloys will be verified at component level and under novel joining methods. In parallel with the metallic one, a thermoplastic fuselage panel will be constructed and tested only for static test.

For the purposes of testing, advanced measurement and monitoring techniques will be required for detecting onset of damage, such as onset of buckling and post buckling deformations during test. Digital Image Correlation (DIC) is an advanced alternative method to the standard practise of employing extensometer and optical methods. DIC method allows more accurate and global definition of deformed shape of test article with reduced cost and time of data processing. Its advantage is that allows having an overall view of the component's deformation at real time and with a fraction of the cost of traditional optical methods.

The target with regards to technology level is to improve the current TRL levels of the above mentioned technologies from 3-4 to 6 for the metallic demonstrator and 5 for the Thermoplastic demonstrator upon the completion of full scale testing and evaluation.

Description of test article

The structure under consideration will be a section of a stiffened fuselage panel that is required to be tested at combined loading conditions of pressure and direct tension/compression and shear. Loading cases for test will be provided by the topic manager. An example of the assembly of the fuselage sections (Metallic and TP) is presented in the figures below (Figure 1 and 2).

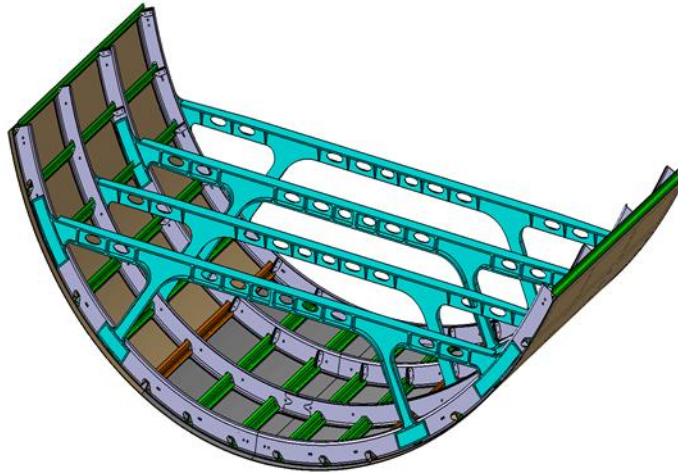

Figure 1: Typical commercial aircraft fuselage section with floor beams

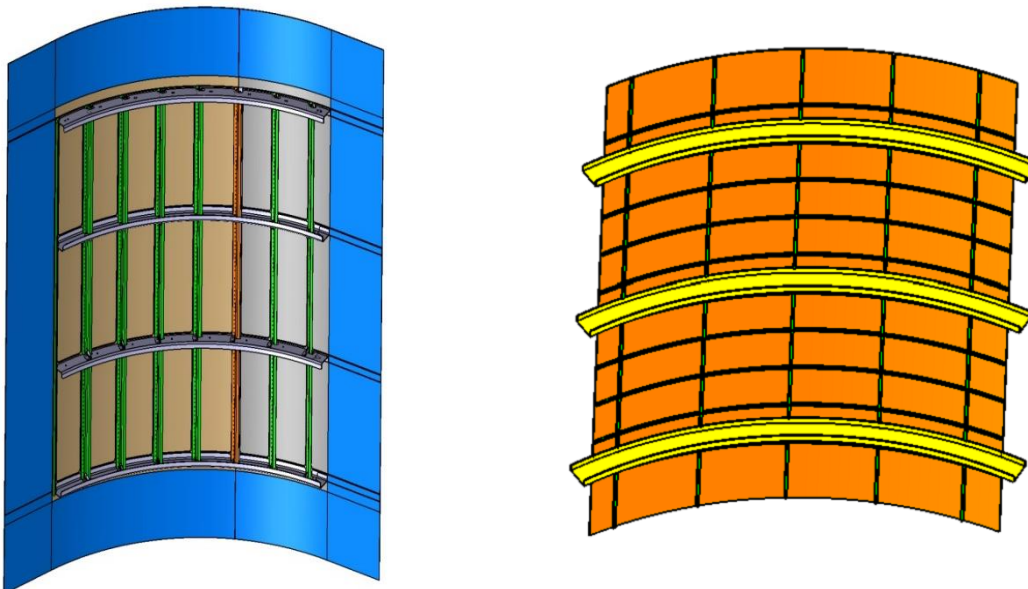

Figure 2: 3D model of the fuselage panels to be manufactured and tested (metallic left and TP right)

Indicative dimensions of both panels are the following:

Length	: 1-2.4m
Peripheral length	: 1-1.6m
Radius	: 1.1-1.65 m

The final panel dimensions will be defined by the topic manager prior initiation of the project, when

design parameters and manufacturing demonstrator tests will determine feasibility of specific structural configuration.

One of the following three options for the test configuration can be proposed as guidance to applicants:

1. Testing set up of a fuselage panel, as shown on figure below (Figure 3). If an adaptation jig is required for attaching the panel to the testing machine then this will be designed and manufactured by the applicant.
2. A pressurization bending and torsion test set up of a barrel section where a part of the fuselage section to be tested. The rest of the barrel will be a dummy section designed and manufactured by the applicant.
3. Figure 4).

The capability to provide representative boundary conditions to that of a cylindrical shell i.e. as applied in an actual fuselage section will be highly preferred.

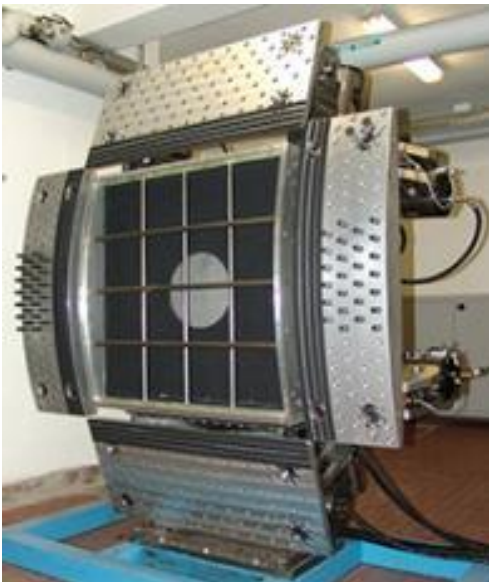

Figure 3: Example of fuselage panel test (courtesy AESDO/POLITO)

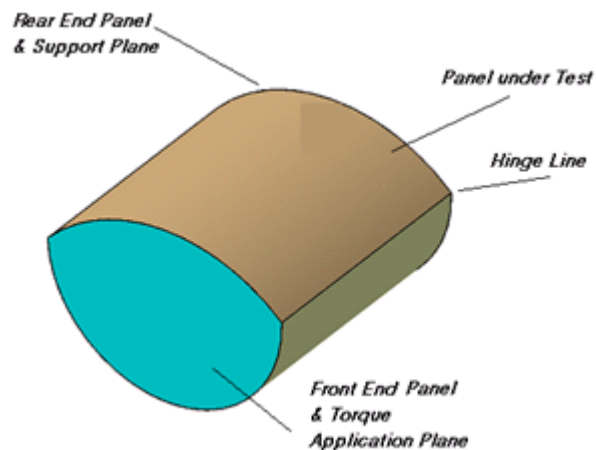

Figure 4: Schematic of D-Box fixture configuration

For the endurance test, the applicant should generate standard size defects at various locations on the panel in order to demonstrate crack initiation and growth under test load conditions. The position and number of defects will be provided by the topic manager. Such locations will be at the external or internal surface of the skin and at the stiffening elements of the structure. For the locations at which accessibility is required prior assembly, these defects will be made and marked accordingly by the topic manager. A crack growth prediction of the most stressed defect shall be provided, for the actual test spectrum to be applied on test, in order to serve as an aid to the endurance test planning and a means of comparison with the test results. Endurance material data for this purpose will be provided by the topic manager.

Loading conditions

Fuselage structures are subjected to a combination of bending, torsion and differential pressure loads. These loading conditions for the test article are applied up to a percentage of limit loads for various combinations of loads up to final ultimate failure test. For fatigue loading, loading conditions will represent the operational conditions of the selected aircraft flight profile.

Below are presented some indicative limit loads for fuselage panel test in order to provide a guideline for the load capability of the test equipment. The final loading conditions depend on the panel dimensions and involvement of design studies. It will be commonly agreed by the topic manager and applicant in order to ensure that load magnitudes generate stress levels that can initiate and grow a crack from the initial size of the generated defects and at a number of cycles representative for the use of a business jet.

Static Test Loads

- Positive Bending Moment [M+], $M = +60000$ kgm Limit
- Negative Bending Moment [M-], $M = -25000$ kgm Limit
- Shear Force, $V = 20000$ kg Limit

The above loads are per the whole A/C section with radius of 1.1m and are limit loads

The Panel Structure shall be analyzed for:

- Ultimate load = Limit Load * Safety Factor of 1.5

In addition to the general fuselage load cases the panel structure shall be substantiated for cabin pressure, where:

- $1\Delta P = 9.0$ psi
- Also it will be subjected to ultimate cabin pressure acting alone of:
 - $2\Delta P = 18.0$ psi

Both metallic and thermoplastic test articles will be delivered by the topic manager. A test plan will be elaborated by the applicant in close cooperation with the topic manager.

At static test conditions, loads up to structural instability shall be reached, while internal pressure is applied and buckling shape shall be measured at independent compression and shear loads and finally at a combination of both load conditions, prior ultimate panel failure test.

Endurance test loads

Endurance test loads shall be representative of a flight mission profile of a typical business jet aircraft. The load spectrum shall include ground and flight load conditions and accelerations resulting from gust and manoeuvre loads. Since multidirectional loading is crucial for examining the growth direction of crack in stiffened structures, especially shear load, a combination of above loads shall be used during endurance test. As a reference the TWIST (Transport **W**ing **S**tandard) load spectrum for commercial transport aircraft is suggested to be used. The applicants that will make available for endurance test a flight profile for a fuselage panel of a commercial jet, will be highly preferred. From the flight spectrum the applicant should generate a final condensed fatigue spectrum that will be agreed with the topic manager, prior initiation of endurance test. Fatigue loading will be applied up to a point that critical crack length is reached for the first defect. Continuation of the test for allowing growth of remaining defects will be done upon controlling the growth of developed cracks by standard repairs. Crack growth monitoring shall be performed in order to enable accurate correlation of crack length with number of cycles reached. A number of cycles equivalent to 40,000 flights are expected to be reached or a total of 500,000 cycles of combined loading.

Instrumentation and Data acquisition

Both metallic and thermoplastic panels that will undergo the static failure test shall be instrumented with specific sensors that enable monitor and measurement of strain and deformations of the test article such as strain gages. The specific locations will be provided by the topic manager, in order to monitor and record the test article behaviour during test and provide data for the correlation with the FEM analysis.

With regards to the metallic panel that will undergo fatigue test, instrumentation shall be employed for

the purposes of correlating damage progression to specific load history. All data collected shall be provided to the topic manager along with the test prediction and evaluation report. Data format to be provided will be commonly agreed prior project initiation.

It is underlined that applicants that will provide test capability including all above load types (i.e. tension-compression, shear and pressure) for the test article, will be highly preferred to those that will propose part load capability.

Inspection and repair requirements

Visual inspection should be performed at each 5000 cycles interval and NDI at each 10000 cycles interval for detecting damages on undamaged areas. Repairs that will be required for defects that have developed prior others, shall involve operations ranging from stop drilling and sealing to small scale patch repair. Applicants that will provide capability for monitoring crack length with novel technologies will be preferred.

Upon completion of testing activities, test articles shall be returned to topic manager's facilities for further evaluation.

Task Description:

Tasks		
Ref. No.	Title – Description	Due Date
1	Project management Project management shall include a comprehensive schedule of activities that will be monitored throughout the duration of the project	T0+24
2	Static and Endurance Test Plan A detail plan of the preparation work required for each demonstrator shall be performed, along with the detailed test steps for each demonstrator.	T0+4
3	Test prediction analysis A FEM prediction of the linear and non linear response of the static test demonstrators should be performed in order to aid definition of the magnitude and increment of loads during test. Also to enable a means of comparison with measured values. Non linear post buckling failure analysis of the metallic panel is also required for comparison with final failure load. A crack growth prediction analysis of the most stressed defect shall be also performed. The effect of the residual stresses on crack path evolution shall be taken into account and examined accordingly for the crack growth prediction analyses of welded regions.	T0+6
4	Design and manufacturing of adaptation tools Design and manufacture of adaptation tools that will be needed in order to attach test articles to the test machine	T0+10
5	Test article instrumentation & calibration With information provided from task 3 and in coordination with the TM, specific drawings will be prepared with the detailed list of sensors that will be installed on test articles.	T0+12

Tasks		
Ref. No.	Title – Description	Due Date
6	Thermoplastic panel static test The thermoplastic panel shall be tested up to failure. Advanced deformation imaging techniques such as DIC shall be used in order to measure accurately the onset of failure and the post buckling behaviour of the panel.	T0+14
7	Fatigue Spectrum Compilation Simplified fatigue test spectrum will be compiled by the applicant in order to be able to generate required damage equivalent to the flight spectrum loading.	T0+14
8	Metallic Panel Endurance Test Completion Completion of the endurance test will be concluded upon reaching criteria combining evolution of length of generated damages and number of cycles of spectrum loading.	T0+19
9	Metallic panel static test The metallic panel shall be tested up to failure. Advanced deformation imaging techniques such as DIC shall be used in order to measure the onset of failure and post buckling behaviour of the panel.	T0+21
10	Evaluation of test results and documentation of test campaign Static test results data should be reported for both metallic and thermoplastic panels while endurance test data only for the metallic panel. A comparison of measured with the predicted response shall be reported.	T0+24

3. Major Deliverables/ Milestones and schedule (estimate)

*Type: R=Report, D=Data, HW=Hardware

Deliverables			
Ref No.	Title – Description	Type*	Due Date
1	Test Plan report	R	T0+4
2	Thermoplastic and metallic panels static test prediction analysis report	R	T0+6
3	Delivery of test adaptation tools	HW & R	T0+10
4	Thermoplastic panel static test report	R	T0+14
5	Metallic panel fatigue spectrum and endurance test prediction report	R	T0+18
6	Metallic panel static test report	R	T0+21
7	Thermoplastic panel test article delivery	HW	T0+22
8	Metallic panel fatigue test report	R	T0+24
9	Metallic test articles delivery	HW	T0+24

Milestones			
Ref. No.	Title - Description	Type*	Due Date
1	Review of design data	R	T0+4
2	Review of component design and test plan	R	T0+6
3	Panel Configuration for full scale test	R	T0+10
4	Tests evaluation closed	R	T0+24

4. Special skills, Capabilities, Certification expected from the Applicant(s)

Essential:

- Experience in testing of large aerospace structures for research or airworthiness certification purposes for commercial aircraft (metallic and composite).
- Record in test prediction analysis using CAE methods (FEM analysis) and LEFM
- Experience in application of traditional and innovative test measurement techniques, DIC, IR Thermography

Advantageous:

- Capability to design and construct large scale tooling.

5. Abbreviations

TRL	Technology Readiness Level
TM	Topic Manager
CfP	Call for Proposals
LBW	Laser Beam Welding
FSW	Friction Stir Welding
LEFM	Linear Elastic Fracture Mechanics
PDR	Preliminary Design Review
CDR	Critical Design Review
CAD	Computer Aided Design
FEM	Finite Element Model
DIC	Digital Image Correlation
IR	Infrared
TP	Thermoplastic
kgm	kilogram meter
CAD	Computer Aided Design
FEM	Finite Element Model
DIC	Digital Image Correlation
IR	Infrared
TP	Thermoplastic
kgm	kilogram meter

IV. JTI-CS2-2020-CFP11-AIR-03-11: Development and execution of new test methods for thermoset panel manufactured in an automated tape layup of dry unidirectional fibres (UD) or non-crimped fabrics (NCF) and subsequent infusion

Type of action (RIA/IA/CSA):		IA	
Programme Area:		AIR	
(CS2 JTP 2015) WP Ref.:		WP C-2.3	
Indicative Funding Topic Value (in k€):		500	
Topic Leader:	University of Stuttgart	Type of Agreement:	Implementation Agreement
Duration of the action (in Months):	24	Indicative Start Date (at the earliest)⁴⁸:	> Q4 2020

Topic Identification Code	Title
JTI-CS2-2020-CFP11-AIR-03-11	Development and execution of new test methods for thermoset panel manufactured in an automated tape layup of dry unidirectional fibres (UD) or non-crimped fabrics (NCF) and subsequent infusion
Short description	
The topic addresses the validation of the structural behaviour of a thermoset panel consisting of stiffeners and skins. The test results shall demonstrate the competitiveness of the newly developed manufacturing process and the potential of this technology. The response of the structure to defined static loads will also sharpen the understanding of the chosen manufacturing concept and design.	

Links to the Clean Sky 2 Programme High-level Objectives⁴⁹				
This topic is located in the demonstration area:			Eco-Design	
The outcome of the project will mainly contribute to the following conceptual aircraft/air transport type as presented in the scene setter:			Advanced short / medium range	
With expected impacts related to the Programme high-level objectives:				
Reducing CO₂ emissions	Reducing NO_x emissions	Reducing Noise emissions	Improving EU Competitiveness	Improving Mobility
<input checked="" type="checkbox"/>	<input type="checkbox"/>	<input type="checkbox"/>	<input checked="" type="checkbox"/>	<input type="checkbox"/>

⁴⁸ The start date corresponds to actual start date with all legal documents in place.

⁴⁹ For further info see Chapter 1 "Introduction to the Programme Scene Setter / Objectives" with key technology themes / demonstration areas. Detailed information available in the CS2 Development Plan accessible via the Clean Sky JU Website and EC Participant Portal.

1. Background

ecoTECH's project, which is part of Activity Line C of AIRFRAME ITD, aims to develop and demonstrate the technologies required to improve the environmental footprint of future aircraft life cycle. Currently used manufacturing technologies for most structural composites, like e.g. the use of pre-impregnated fabrics or tapes which are laid-up on tools, vacuum bagged and cured in an autoclave under elevated pressure and temperature, are very energy-intensive and expensive.

Within ecoTECH, different innovative technologies are investigated in order to achieve substantial improvements on the key levels of thermoset composite manufacturing. Besides novel tooling concepts and optimized infusion processes, the Advanced Ply Placement (APP) technology is used. APP is an innovative process for the fully automated production of large CFRP components. Originally developed for the placement of prepreg materials, APP will be optimized for the placement of dry fibre placement directly into a 3D mould with subsequent infusion of the preform. This method reduces waste of material and offers potential for automation. A demonstrator of a stiffened panel will be the result of such activities. A further important component of the ecoTECH project is the consideration of life cycle analysis (LCA), which is also applied in the context of this work.

The aim of the topic is to validate the new and innovative manufacturing technologies compared to state-of-the-art methods. The tests to be carried out should show the structural integrity, its performances and the component behaviour under load, as well as demonstrate the competitiveness of the production methods. The test campaign has to incorporate innovative approaches for the demonstrator testing and analysis such that the scope of the tests (i.e. number of specimens) can be reduced. Such an approach would decrease the workload for manufacturing large scaled demonstrators and minimize costs while keeping the highest possible degree of accuracy and significance of the results.

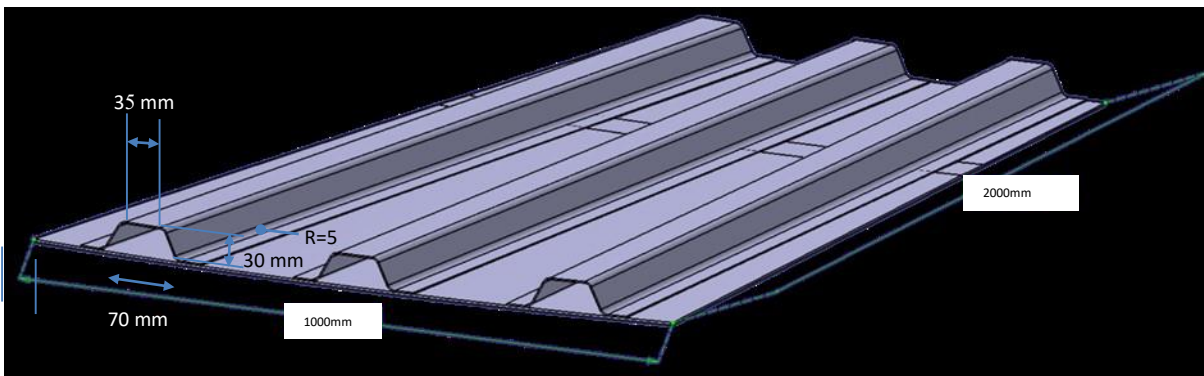

Figure 1: Example of a sketch of the demonstrator, geometries subject to change

2. Scope of work

In this topic, the performance capability of the automated tape layer process with dry UD tape or NCF and its subsequent infusion shall be validated by a specified testing program. The test matrix shall follow the building block approach from Level 2 (Structural details) to Level 3 (Subcomponent). The test components for Level 2 and Level 3 testing will be provided by the Topic Manager. Level 1 trials will be completed by the topic manager before the start of the project and the results may be made available to the applicant if necessary. They will include standard coupon tests like compression, tension, shear as well as characterization of fracture Mode I+II and mixed mode. All tests will be executed under ambient conditions and quasi-static loads. Since Hot/Wet and fatigue behaviour of the components are of great relevance but are not expected to be feasible within the given budget, they will be addressed by the Topic Manager afterwards if requirements arise. LCA data must be collected by the applicant on the

basis of an individual questionnaire provided.

Level 2 (Structural details)

The applicant has to bring in innovative approaches to reduce the test volume and costs of level 3 testing by new tests or test methods in level 2 (i.e. methods and technologies for out of plane failure modes monitoring at real time). They ideally shall allow predicting the structural behaviour of the demonstrator in level 3. Selected components will be produced with conventional methods (e.g. prepreg hand layup), in order to facilitate the comparison with APP. Since the manufacturing of full scale demonstrators is time consuming and cost intensive the new approaches shall mitigate the APP production technology risks early at level 2 and provide validated information to use only one validation test in level 3 (i.e. one APP and potentially one prepreg).

Level 3 (Subcomponent)

Level 3 shall focus on validating design methodologies employed in subcomponent design and the performance of new manufacturing processes and used materials. As required for level 2, innovative approaches for the test setup, for force introduction, measurement data acquisition and test execution has to lead to a reduction of test time and test scope in level 3 testing. The aim is to get by with just one demonstrator (i.e. one APP and potentially one prepreg) and still shows that the innovative manufacturing technologies and materials used for the realization of the demonstrator have a high level of confidence.

Specimen boundary and load introduction conditions are more representative of the actual structure than in the element tests. Biaxial loading can be applied. The level of specimen complexity allows incorporation of representative structural details. The resulting load distributions and local bending effects become observable and out-of-plane failure modes become more representative of full-scale structure.

It is proposed to structure the activities in the following tasks:

Tasks		
Ref. No.	Title - Description	Due Date
Level 2 Test		
L2-Tk0	Preparation of test plan for level 2 tests (in coordination with topic manager)	T0+2
L2-Tk1	Design and manufacturing of test tools	T0+5
L2-Tk2	Testing	T0+8
L2-Tk3	Test report + LCA data	T0+9
Level 3 Test		
L3-Tk0	Preparation of test plan for level 3 testing (in coordination with topic manager)	T0+11
L3-Tk1	Design, manufacturing and installing of test fixtures	T0+15
L3-Tk2	Testing	T0+22
L3-Tk3	Test report + LCA data	T0+24

Level 2 Tests

The following tests are expected (final list of tests and number of coupons to be confirmed and defined at the beginning of the project):

- Crippling
- Compression / Shear test

- Stringer/Skin CAI
- 7-point-bending test

L2-Tk0 Preparation of test plan for level 2 testing

In collaboration with the topic manager the Applicant shall develop a test plan for level 2 testing. Especially new innovative approaches for in-situ damage monitoring are highly recommended to be implemented in level 2 testing in order to reduce cost amount of testing.

L2-Tk1 Design and manufacturing of test tools

Design and manufacturing of the test tools shall start after the acceptance and approval of the test plan L2-Tk0. Main requirements and features needed for level 2 testing will be provided and planned at the beginning of this project.

L2-Tk2 Testing

Tests are to be done according to the test plan defined in L2-Tk0. The topic manager might join the testing at the facilities of the applicant. Any deviations from the standards jointly defined at the beginning of the project are to be reported to the topic manager and changes to the defined test plan are only acceptable with prior approval of the topic manager. These tests will either validate the chosen design or help to define an optimized design for the demonstrator. They will also help to define the level 3 test setup and volume. Tests are to be performed under ambient conditions and quasi-static loading.

L2-Tk3 Test report + LCA data

The final deliverable of level 2 is a conclusive test report and the handover of the collected LCA data. Preliminary test results have to be communicated on the request of the topic manager. They might influence the test plan and setup for level 3 testing.

Level 3 Tests

The overall dimensions of the demonstrator are about 2m x 1m (flat or curved) with 2mm thick panel and 1.5mm thick omega stiffeners. An indicative sizing of the omega stiffeners is given in Figure 1, but these are expected to change slightly after final design. Preliminary loads required for compression and tension are about 200 tons and 150 tons respectively. Load cases to be tested are compression, tension, shear and possibly combinations of these. One load case will be tested until failure.

L3-Tk0 Preparation of test plan for level 3 testing

The applicant will participate to work out with the topic manager the test plan for level 3 testing. The test plan shall define all details and conditions necessary for the successful execution of the tests and reflect the exact test sequences. It also has to show the innovative approach to reduce the testing scope.

L3-Tk1 Design, manufacturing and installing of test fixtures

Design and manufacturing of the test tools shall start after the acceptance and approval of the test plan L3-Tk0. Main requirements and features needed for level 3 testing will be provided and planned at the beginning of the project. Level 2 test results might influence some details of the level 3 testing. The final design shall take into account among others:

- Rigidity of the test setup
- Adaption and assembly of the specimen to the test rig
- Load application systems and devices
- Suitable and sufficient test monitoring (e.g. strain gages, optical measurement systems, high-speed cameras etc.)
- Repeatability and traceability of experiments

L3-Tk2 Testing

Tests are to be done according to the test plan defined in L3-Tk0. The Topic manager might join the testing at the facilities of the applicant. Any deviations from the defined standards are to be reported to the topic manager and changes to the defined test plan are only acceptable with prior approval of the topic manager.

The applicant is responsible for ensuring that all the superstructures, instrumentations, actuators and data acquisition systems (e.g. optical strain measurement) required for the tests are available on schedule and that the tests are carried out according to plan.

L3-Tk3 Test report + LCA data

The final deliverable of level 3 is a conclusive test report and the handover of the LCA data of level 3 testing. Preliminary test results are to communicate on the request of the topic manager. Data evaluation must be traceable and transparent.

General Remark:

The topic manager will provide the information to the selected applicant (general requirements, specification, etc.) and will supply the specimen to be tested.

The applicant shall work in close coordination with the topic manager at all times and shall communicate any recognizable problems or deviations from defined processes openly and at an early stage. The applicant shall manage and lead all the activities included in this document. The selected applicant is responsible for the design, the manufacturing and the installing of the fully functional test rig at its facilities, for the execution of all defined tests and the test results delivery.

All activities are always to be performed under the supervision of the topic manager.

IP-management and further details to the abovementioned topics will be discussed with the applicant when selected.

3. Major Deliverables/ Milestones and schedule (estimate)

*Type: R=Report, D=Data, HW=Hardware

Deliverables			
Ref. No.	Title - Description	Type*	Due Date
D1	Level 2 test plan proposal (in collaboration with TM)	R	T0+2
D2	Level 2 test report + LCA data	R	T0+9
D3	Level 3 test plan proposal (in collaboration with TM)	R	T0+11
D4	Level 3 final test report + LCA data	R	T0+24

Milestones			
Ref. No.	Title - Description	Type*	Due Date
M1	Kick off meeting	R	T0
M2	Level 2 critical design review: tooling and test set up	R	T0+9
M3	Level 2 test report	R	T0+12
M4	Level 3 critical design review: tooling and test set up	R	T0+13
M5	Level 3 test readiness review: tests start	R	T0+15
M6	Final test report	R	T0+24

4. Special skills, Capabilities, Certification expected from the Applicant(s)

Essential:

- Quality System to assure the Quality of all Products and Services performed by the Test Lab. Quality System International Standards (i.e. EN 9100:2009/ ISO 9001:2008/ ISO 14001:2004).
- Suited load cells, universal testing machines, strain measurement systems (among others: 3D non-contact strain measurement, clip-on extensometer, strain gages), hydraulic actuators, flexible test



field.

- Access to a workshop for manufacturing of individual test fixtures, advanced NDT systems and expertise.
- Access to design and analysis tools compatible to the standards of the aeronautical industry (e.g. Catia V5), data management system, data storage system, high-speed camera systems, impactor.
- Capability to realize this project in terms of expertise, manpower, test facilities

Advantageous:

- Ability to minimize test effort with the development of innovative test approaches.
- Strong knowledge and experience in mechanics, tooling design and composite components at coupon level and structural testing.
- Expertise in developing, managing and execution of test programs with fibre reinforced plastics.
- Experience in working in an international project team with an aeronautical background.

5. **Abbreviations**

APP	Advanced Ply Placement
CAI	Compression After Impact
CFRP	Carbon Fiber Reinforced Plastic
IP	Intellectual Property
LCA	Life Data Assessment
NCF	Non-Crimped Fabric
NDT	Non Destructive Testing
TM	Topic Manager
UD	Unidirectional fibres

7. Clean Sky 2 – Systems ITD

I. JTI-CS2-2020-CfP11-SYS-01-22: Oxygen Absorbing Metal-Air-Batteries for Long Term Cargo Compartment Inertisation

Type of action (RIA/IA/CSA):		RIA	
Programme Area:		SYS	
(CS2 JTP 2015) WP Ref.:		WP 2.3	
Indicative Funding Topic Value (in k€):		800	
Topic Leader:	Diehl Aviation Gilching GmbH	Type of Agreement:	Implementation Agreement
Duration of the action (in Months):	24	Indicative Start Date (at the earliest)⁵⁰:	> Q4 2020

Topic Identification Code	Title
JTI-CS2-2020-CfP11-SYS-01-22	Oxygen Absorbing Metal-Air-Batteries for Long Term Cargo Compartment Inertisation

Short description
One of the main challenges for Halon free fire suppression in cargo compartments is the long term inertisation for the ETOPS duration after the initial knock down phase. Known concepts like bottled nitrogen and OBIGGS systems are relatively heavy and have several reliability and safety issues. A novel and very innovative approach for inertisation is binding the oxygen in metal oxides instead of bringing nitrogen into the compartment. Metal-air-batteries are promising candidates for this principle as they allow for a controlled metal-air reaction. In this topic the metal – electrolyte combination shall be selected, a battery integration concept shall be created. A demonstrator shall be built and tested. Finally the demonstrator will be integrated the topic leader Fire Test Facility for long term fire suppression tests.

Links to the Clean Sky 2 Programme High-level Objectives ⁵¹				
This topic is located in the demonstration area:		Cabin and fuselage		
The outcome of the project will mainly contribute to the following conceptual aircraft/air transport type as presented in the scene setter:		Advanced long range		
With expected impacts related to the Programme high-level objectives:				
Reducing CO ₂ emissions	Reducing NO _x emissions	Reducing Noise emissions	Improving EU Competitiveness	Improving Mobility
<input type="checkbox"/>	<input type="checkbox"/>	<input type="checkbox"/>	<input checked="" type="checkbox"/>	<input type="checkbox"/>

⁵⁰ The start date corresponds to actual start date with all legal documents in place.

⁵¹For further info see Chapter 1 “Introduction to the Programme Scene Setter / Objectives” with key technology themes / demonstration areas. Detailed information available in the CS2 Development Plan accessible via the Clean Sky JU Website and EC Participant Portal.

1. Background

Fire suppressions systems are mandatory for all modern large aircrafts which comprise a Class C cargo compartment. These systems currently use the environmentally hazardous extinguishing agent Halon 1301. Due to its ozone depletion and global warming potential, Halon 1301 was banned from production by the Montreal Protocol. The further use of Halon 1301 for cargo compartment fire suppression was limited by EU regulations and was only permitted until the end of 2018 for new type certificate aircrafts. Diehl Aviation developed an environmentally friendly replacement technology based on water mist and nitrogen, which has been proven to be the, so far, only available and officially tested alternative for the current Halon based systems.

The development of specific system components are part of Cleansky 2 ITD Systems WP 2.3 - Cabin and Cargo Systems. The call shall support these efforts by providing a novel technology – Oxygen Absorbing Metal-Air-Batteries - to maintain the inertisation of the cargo compartment during ETOPS time.

In this application the functional objective of the battery is not electrical power generation. The Metal-Air-Battery will be connected to the cargo compartment. Oxygen-rich air from the compartment will oxydize the metal within the battery and oxygen depleted air will be returned to the cargo compartment in order to maintain an inert atmosphere.

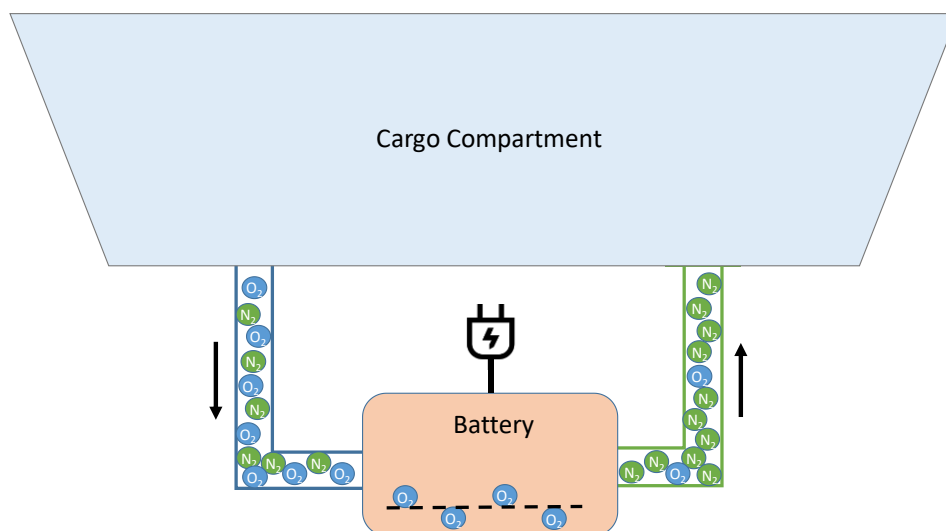

Figure 1: Schematic representation of the envisaged inertisation concept

2. Scope of work

The tasks of this call are summarized in the following table. A more detailed description of work is provided in the subsequent paragraphs. The key characteristics of the envisaged battery system are listed after the task descriptions.

Tasks		
Ref. No.	Title – Description	Due Date
1	Definition and clarification of requirements, boundary conditions, testing metrics and test procedures	T0+3M
2	Selection of metal and electrolyte system	T0+8M

Tasks		
Ref. No.	Title – Description	Due Date
3	Chemical laboratory demonstrator and battery concept	T0+14M
4	Development and design of battery	T0+17M
5	Verification tests and performance assessment of the developed batteries	T0+20M
6	Manufacturing and integration of batteries at fire test facility	T0+22M
7	Proof of concept Fire Suppression tests at topic leader facility	T0+24M

Task 1: The requirements related to functional performance, safety and reliability properties, temperature, mechanical robustness as well as other aviation specific requirements shall be jointly defined in cooperation with the topic leader. Test procedures for functional tests and verification of the prototypes shall be defined.

Task 2: An overview of potentially applicable metal and electrolyte systems shall be elaborated, resulting in a conceptual and comprehensive study to select the most suitable technology(s). As part of the research and innovation action the technology(s) shall be further developed to meet the specific functional requirements e.g. tolerance to fire gases and smoke as well as the aerospace requirements e.g. light weight and high reliability.

Task 3: Develop a detailed battery concept and build a chemical laboratory demonstrator based on said concept. The concept should include novel approaches for electrode design to enable a high material consumption rate and high oxygen absorption rate as well as measures to prevent poisoning of the battery by fire gases. The concept shall ensure long-term storage of the unactivated battery and solutions for its activation in case of a fire alarm event. In addition, suitable analytic capability like x-ray tomography, SEM, TEM, EDX and EBSD to characterize the reaction.

Task 4: Based on the laboratory concept of Task 3 a prototype battery design shall be developed and manufactured. In addition, suitable test equipment/test bench for functional testing shall be developed. The goal of this task is to provide at least four prototype batteries, as well as functional test equipment. These prototype batteries are further used for verification, performance and necessary safety relevant tests (Task 5).

Task 5: The test program that was defined in Task 1 shall be conducted in order to demonstrate feasibility, performance and safe operation of the developed prototype design(s) (refer to Task 4).

Task 6: Based on the verified prototype battery design (refer to Task 4 and 5), batteries for at least 10 fire tests with a duration of 5 h shall be manufactured. The task will be completed by supporting integration of the manufactured batteries at the Topic Manager's fire test facility.

Task 7: The final proof of concept fire suppressions tests are performed at the TM's facility and operation of the batteries during these tests shall be supported by the applicant. The built and tested battery demonstrator shall be described in a reference document which includes all relevant information for reproducing the conducted tests.

The battery demonstrator shall have the following key-characteristics. A detailed list of requirements will be provided by the Topic Manager during the project.

Key Characteristics

- Absorption capability of 1,1g O₂ per second from air with an oxygen Level of 11%
- The use parallel batteries is possible
- Capacity for an operation of 5 hours
- Operation in an air pressure range from 600 mbar to 1100 mbar
- Tolerance to fire gases (CO₂, CO, Smoke)
- Compliance with RTCA DO160 Rev G – especially
 - Materials with Fire-Smoke-Toxicity (FST) requirements for cabin applications
 - Survival of temperatures between -55°C to +85°C
 - Operation in a temperature range between -40°C to +70°C
 - Resistance against certain fluids that occur in aircrafts (e.g. Jet Fuel, Skydrol, cleaning agents) on the battery outside
 - Shocks- and vibrations resistance
- Long term stability of 10 years for the unactivated battery
- Single Use Battery (the system can be replaced after one activation)

The system shall be demonstrated at the Topic Managers fire test facility in Freiberg, Germany (near Dresden). The applicants shall support the integration and tests at the Topic Manager’s facility.

3. Major Deliverables/ Milestones and schedule (estimate)

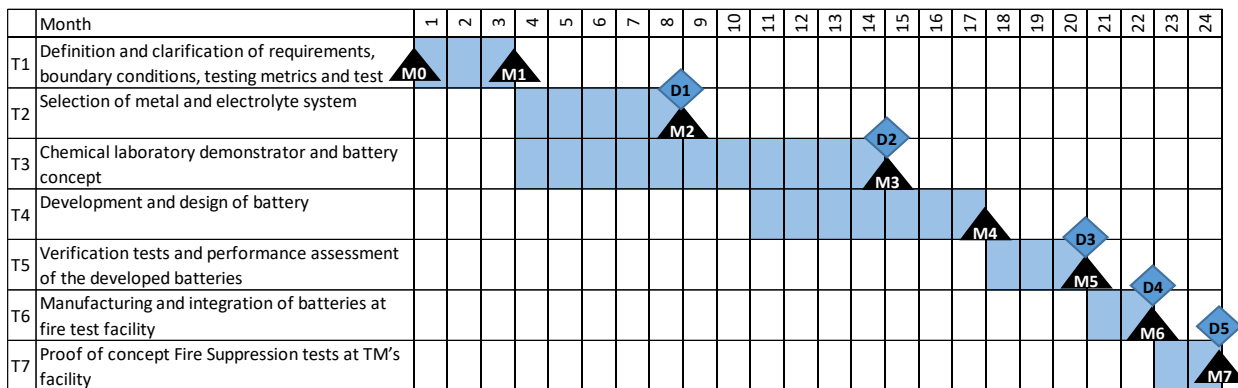

Deliverables			
Ref. No.	Title – Description	Type	Due Date
D1	Report of metal and electrolyte selection	R	T0+8M
D2	Report of chemical laboratory demonstrator & battery concept	R+H W	T0+14M
D3	Verification test report	R	T0+20M
D4	Batteries for 10 fire-tests with 1,1g/sec O ₂ over 5 hours	HW	T0+22M
D5	Reference documentation of battery	D+R	T0+24M

Milestones (when appropriate)			
Ref. No.	Title - Description	Type*	Due Date
M0	Kick-Off meeting conducted	R	T0
M1	Specification document submitted	R	T0+3

Milestones (when appropriate)			
Ref. No.	Title - Description	Type*	Due Date
M2	Review of metal and electrolyte selection conducted	R	T0+8
M3	Design review of battery concept conducted	R	T0+14
M4	Development report submitted and test units for Task 5 available	R/HW	T0+17
M5	Verification test report submitted	R	T0+20
M6	Demonstrator parts provided and integrated into fire test facility completed	HW	T0+22
M7	Proof of concept Fire Suppression tests completed	R	T0+24

4. Special skills, Capabilities, Certification expected from the Applicant(s)

Essential:

- Electrochemical lab
- Ability to design and manufacture test cells and demonstrator cells
- Long term experience with 3D structure-property relationship investigations in battery electrodes
- The ability to perform in-situ or in-operando measurements to characterize the reaction like
 - X-ray tomography (structure and morphology analysis, structure-properties relationships, quantification of material phases)
 - SEM and TEM imaging and analysis capabilities (including EDX and EBSD) (nanostructure of the electrode)
- 3D Analysis
 - oxygen transport paths in the battery volume
 - surface/volume ratios, active surface area
 - 3D electrolyte distributions
- Multiscale analysis (chemical/morphological/metrological)
- Gas/ion/electron flow end network analysis/simulation

5. Abbreviations

EBSD	Electron Backscatter Diffraction
EDX	Energy Dispersive X-ray Spectroscopy
ETOPS	Extended-Range Twin-Engine Operational Performance Standards
FST	Fire-Smoke-Toxicity
RTCA Do160 Rev. G	Environmental Conditions and Test Procedures for Airborne Equipment Do-160
SEM	Scanning Electron Microscopy
TEM	Transmission Electron Microscopy

II. JTI-CS2-2020-CfP11-SYS-01-23: Development of a multi-position valve with associated actuator for cargo fire protection

Type of action (RIA/IA/CSA):		IA	
Programme Area:		SYS	
(CS2 JTP 2015) WP Ref.:		WP 2.3	
Indicative Funding Topic Value (in k€):		500	
Topic Leader:	Safran	Type of Agreement:	Implementation Agreement
Duration of the action (in Months):	20	Indicative Start Date (at the earliest)⁵²:	> Q4 2020

Topic Identification Code	Title
JTI-CS2-2020-CfP11-SYS-01-23	Development of a multi-position valve with associated actuator for cargo fire protection
Short description	
Trend for new aircraft and associated systems is to limit their energy consumption. In the frame of the cargo fire protection a regulated valve piloted by an associated actuator has to be developed allowing to optimize and reduce the bleed air consumption. Optimize the weight, reliability and maintainability of such a valve will be the main targets of this study. The work in this topic will allow to provide a high reliable and low cost multi position valve for inerting applications.	

Links to the Clean Sky 2 Programme High-level Objectives⁵³				
This topic is located in the demonstration area:		Cabin and fuselage		
The outcome of the project will mainly contribute to the following conceptual aircraft/air transport type as presented in the scene setter:		Advanced Short/Medium Range		
With expected impacts related to the Programme high-level objectives:				
Reducing CO₂ emissions	Reducing NO_x emissions	Reducing Noise emissions	Improving EU Competitiveness	Improving Mobility
<input checked="" type="checkbox"/>	<input type="checkbox"/>	<input type="checkbox"/>	<input checked="" type="checkbox"/>	<input type="checkbox"/>

⁵² The start date corresponds to actual start date with all legal documents in place.

⁵³ For further info see Chapter 1 "Introduction to the Programme Scene Setter / Objectives" with key technology themes / demonstration areas. Detailed information available in the CS2 Development Plan accessible via the Clean Sky JU Website and EC Participant Portal.

1. Background

In the frame of SYSTEMS ITD WP2.3 (cabin and cargo systems), a cargo compartment fire-suppression system is being developed to replace the existing Halon-based suppression system. This new system will avoid any dispersion of CFC gases (components with high Ozone Depletion Potential and high Global Warming Potential), hence it will reduce the aircraft impact on the degradation of the atmosphere. It is composed of a knock-down system interfaced with an on board inert gas generation system (OBIGGS) to maintain an inert atmosphere in the cargo compartment.

This inerting system is based on the use of polymeric membranes that separate the air gases. The membrane, also called ASM (Air Separation Module), is fed with compressed air coming from the bleed air circuit or from a dedicated compressor. By a phenomenon of diffusion, part of the oxygen is removed from the feed air. The Nitrogen Enriched Air (NEA) recovered at the end of the membrane is injected in the cargo compartment to reduce the oxygen percentage below 12% of the air volume and maintains an inert atmosphere. NEA is not detrimental to the earth's atmosphere.

Similar types of inerting systems are already operated to protect the fuel tanks. A trend for the future is to use the same equipment for fuel tank inerting and fire-suppression in the cargo bay. The stream of gas would be injected in the fuel tanks during the flight and automatically diverted to the cargo compartment as soon as a fire alarm occurs. As the fire-suppression system is essential (unlike the fuel tank inerting system), priority would automatically be given to the first one. The inerting system would be mainly defined according to the fire-suppression function requirements.

Fuel tank inerting system is permanently fed with bleed air during the flight.

Up to now, NEA flow is controlled by a traditional two-position valve (high flow or low flow). The new valve proposed in this call will allow a fine regulation of the NEA flow, hence to inject exactly the requested quantity of NEA to inert the volumes (cargo compartment or tank) and avoid any waste of gas. Doing that will allow to reduce the OBIGGS bleed air consumption, and consequently the fuel consumption and the associated production of CO₂.

A schematic describes the location of this multiposition valve, also called FCV (flow control valve).

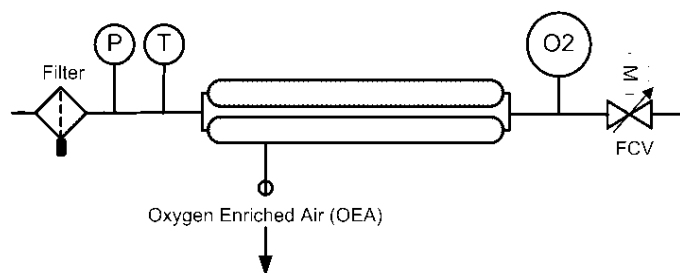

The electrically driven valve shall adjust its passage's section to regulate the flow thanks to electrical current provided to the valve (closed loop system with gauging and flow evaluation means).

2. Scope of work

The objective of this project is to develop, build and test a demonstrator at TRL 6 of such a multiposition flow control valve.

A technical specification defining the NEA characteristics pressure and flow ranges as well as the expected regulation characteristics (accuracy, response time) will be provided at the start of the project by the Topic Manager. Note that the temperature of the gas will generally be around 75°C.

Preliminary Range of characteristics :

Flow rate : from 2,5 g/s to 40 g/s

Expected accuracy (including aging of the valve) is +/-10 % of the flow

Upstream pressure : From 5 bar abs to 1,2 bar abs depending on the flight phase. Max flow is linked to max pressure.

This table is provided as a guide for preliminary estimation of the valve size:

Pressure upstream of the valve	Bar abs	5	3	1.2
Pressure downstream of the valve	Bar abs	1	1	0.3
Gas flow	g/s	40	10	2.5

Air Leakage : no internal leakage when closed

Power supply: 28 VDC

Consumption: less than 1 A

The project is split in several tasks.

Tasks		
Ref. No.	Title – Description	Due Date
T1	Specification reception	T0+1M
T2	Review of the pneumatic valve technologies	T0+2M
T3	Selection of the concept via trade off analysis	T0+3M
T4	Prototypes Design	T0+9M
T5	Prototype manufacturing	T0+15M
T6	Prototypes qualification test done by the selected partner	T0+20M

Task 1: Collect from the topic leader the parameters (pressure, flow rate, temperature, vibration) which will be the base to provide an accurate specification.

Task 2: Review of the pneumatic valve technologies available to provide a regulating valve with very high reliability, low maintenance, and competitiveness.

Evaluation of the pros and cons of the technologies proposed for the mechanical and pneumatic parts of the control valve, as well as for the actuator, according to the specification requirements delivered by the Topic Manager at the beginning of the project.

Task 3: selection of the best candidate technology. Evidences and trade off of the technology that provides a high reliability, low weight and low production cost will be delivered, based on analysis, similarity or tests

The objective is to successfully pass a TRL3 review. It is considered that the applicant already masters the technology at the TRL3 level.

Task 4: Design of a pneumatic valve with an actuator based on the selected technology. This task will include the evidences of the high reliability, low weight, maintainability and accuracy capabilities of the equipment. Intermediate mock-ups can be built to demonstrate the characteristics of the valve & its associated actuator if deemed necessary by the applicant. Development will be conducted according to main aerospace standards (especially for actuator).

Task 5: Manufacturing of the prototypes (pneumatic valve + actuator). One of these propotypes will be integrated in an OBIGGS instead of the traditionnal flow control valve. The quantity of components will be determined by the applicant. (For information, a quantity of 5 to 7 valves + actuators is a preliminary

estimation).

Task 6: Valve + actuator test campaigns performed by the applicant and will integrate at least:

- Verification of the pneumatic and electrical performances of the valve and actuator (mainly accuracy, response time, electrical performances) in “lab conditions”
- Verification of the performances of the valve in “real conditions”: low and high temperature
- Long-term endurance tests of the valve+actuator (on/off cycles)
- Environmental test campaign according to DO160 standards to prove that the equipment operates in any environmental conditions: vibrations, acceleration, EMC, lightning

3. **Major Deliverables/ Milestones and schedule (estimate)**

Deliverables			
Ref. No.	Title – Description	Type	Due Date
D1	Trade off analysis	R	T0+3month
D2	Prototype design	R	T0+9
D3	Prototypes manufacturing	HW	T0+15
D4	Qualification report	R	T0+18
D5	Documentation for TRL6 MRL6 evaluation	R	T0+20

Milestones (when appropriate)			
Ref. No.	Title – Description	Type	Due Date
M1	Trade off analysis	R	T0+3month
M2	CDR and TRL 3 milestone	R	T0+8
M3	Prototypes delivered to topic manager	HW	T0+15
M4	TRL 6 report with lessons learnt	R	T0+20

4. **Special skills, Capabilities, Certification expected from the Applicant(s)**

Essential:

- Significant experience on design, qualification of very high reliability pneumatic valve and actuators
- Capability on industrializing aerospace valves and associated actuators
- Capability to develop according to aerospace standards
- Capability to provide and test prototypes meeting aerospace requirements

Advantageous:

- Ability to perform tests of the assembly valve + actuator in an harsh environment

5. **Abbreviations**

EMC	Electric Magnetic Compatibility
FCV	Flow Control Valve
NEA	Nitrogen Enriched Air
NEADS	Nitrogen Enriched Air Distribution System
OBIGGS	On Board Inert Gas Generating System

III. JTI-CS2-2020-CfP11-SYS-02-62: Thermoplastic wheel for electrical Environmental Control System

Type of action (RIA/IA/CSA):		IA	
Programme Area:		SYS	
(CS2 JTP 2015) WP Ref.:		WP 6.1	
Indicative Funding Topic Value (in k€):		750	
Topic Leader:	Liebherr Toulouse	Type of Agreement:	Implementation Agreement
Duration of the action (in Months):	30	Indicative Start Date (at the earliest)⁵⁴:	> Q4 2020

Topic Identification Code	Title
JTI-CS2-2020-CFP11-SYS-02-62	Thermoplastic wheel for electrical Environmental Control System
Short description	
Several technology bricks are developed to address needs for a future Electrical ECS allowing significant benefits in terms of fuel consumption reduction through more efficient use of aircraft energy. Air cycle machines used in air cooling systems integrates usually one of several thermodynamic stages composed of a wheel. The aim of the topic is to develop a process to realize a flange wheel in thermoplastic composite (PAEK) to reduce weight and optimize the performance of the turbine wheels or compressor.	

Links to the Clean Sky 2 Programme High-level Objectives ⁵⁵				
This topic is located in the demonstration area:		Environmental Control System		
The outcome of the project will mainly contribute to the following conceptual aircraft/air transport type as presented in the scene setter:		Advanced Short/Medium-range		
With expected impacts related to the Programme high-level objectives:				
Reducing CO ₂ emissions	Reducing NO _x emissions	Reducing Noise emissions	Improving EU Competitiveness	Improving Mobility
<input checked="" type="checkbox"/>	<input type="checkbox"/>	<input type="checkbox"/>	<input checked="" type="checkbox"/>	<input type="checkbox"/>

⁵⁴ The start date corresponds to actual start date with all legal documents in place.

⁵⁵ For further info see Chapter 1 "Introduction to the Programme Scene Setter / Objectives" with key technology themes / demonstration areas. Detailed information available in the CS2 Development Plan accessible via the Clean Sky JU Website and EC Participant Portal.

1. Background

In the frame of Clean Sky 2 - Systems ITD, several technological bricks are developed to address needs for a future Electrical ECS which allows significant benefits:

- Fuel consumption reduction through more efficient use of A/C energies
- Improvement of A/C availability by increasing systems reconfiguration capabilities

Air cycle machines (ACM) used in air cooling systems integrates usually one of several thermodynamic stages (turbine or compressor) composed of a wheel (rotating part), a potential stator stage (injector or diffuser) and a scroll (See Fig. 1).

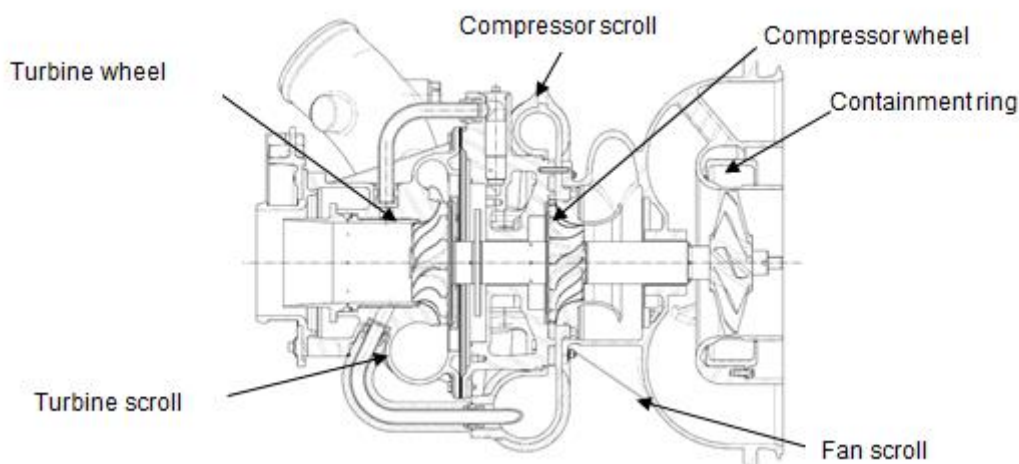

Fig. 1: Cross section of an Air Cycle Machine (ACM).

In classical pneumatic Environmental Control System (ECS) the compressor has a moderate pressure ratio (~ 1.4) as pressurized air is taken from the engine. The turbine has a more important pressure ratio (~ 4) and its efficiency impacts the ECS consumption. The performance of the turbine wheel represents then a major parameter to enhance the global performance of the ECS.

In new electrical ECS, the compressor has to make all the compression ratio (up to 5) and becomes then the most important wheel to optimize. It is very difficult today to meet enough efficiency with classical compressor wheel for this kind of application.

The capability of manufacturing flange compressor wheel for electrical ECS, or flange turbine wheel for pneumatic ECS would result in an important gain:

- The efficiency of the turbine or compressor will increase of 5 to 10 points as already observed in previous projects,
- For pneumatic ECS this efficiency gain will result in a lower air bleed consumption and then directly reduce the aircraft fuel consumption,
- For electrical ECS, this efficiency gain will result in lower electrical consumption and lower maximum power consumption that drives the electrical motor and power electronic design,
- The size and mass of the motor and power electronics will decrease and then reduce the aircraft consumption.

Today it is easy to produce by injection a flange or a wheel, but producing flange wheel is a big challenge as any available capable process is there. Only additive manufacturing could allow to produce this kind of flange wheel. But material available for additive manufacturing have too low mechanical properties

(30 to 50 MPa) and doesn't allow to reach required performances. The thermodynamic performance has been assessed but the process and the mass of the wheel does not allow us to use it in serial applications.

A prototype of flange compressor for electrical ECS has already been manufactured in 3D print titanium and tested. The use of titanium leads to double the mass of the wheel and increase then dynamics constraints on the rotor.

A new process has to be investigated allowing to manufacture thermoplastic flange wheel with material with carbon fibers and capable to reach mechanical properties between 250 to 300 MPa.

Today, as far as we know, there is no process with such capability. Studies and analysis would be led to determine an innovative process to produce this part in one shot or with several associated processes.

The capacity to produce a flange wheel in a lighter material is needed to allow its use in an e-ECS application. The capability to manufacture flange wheels will allow to meet design constraint to use this technology in aircraft air systems.

2. Scope of work

Tasks		
Ref. No.	Title - Description	Due Date
Task 1	Definition of the requirement	M2
Task 2	Choice of the flange wheel	M6
Task 3	Definition, design, calculation of a flange wheel	M12
Task 4	Conception and manufacturing mould and flange wheel prototypes	M26
Task 5	Characterization and testing of the flange wheel on the air cycle machine	M30

Task 1: Definition of the requirements

At the beginning of the project, the Topic manager will define the following requirements:

- Nature of the material with PAEK family (sub-family of PEEK and PEKK)
- Conditions during service : speed, pressure, temperature, atmosphere, stress

Task 2: Choice of the flange wheel

The selected flange wheel that will be developed will be done in collaboration with the Topic manager and according to the feasibility of the part with respect to the technology. The technical requirements and inputs related to the selected part will be provided by the Topic manager to the applicant. Potential dimensions of the flange wheel are 70 - 160mm diameter and 20-50 mm length.

Task 3: Definition, design, calculation of a flange Wheel

As the choice of the flange wheel is determined the flange wheel has to be defined. The design must take into account the constraints of the process (homogeneous, dimensions tolerances, thickness, radius). This wheel will undergo a calculation of stress in order to ensure its mechanical performance. The final design and the calculation of stress will be carried out in collaboration with the partners of the project and validated by the topic manager.

Task 4: Conception and manufacturing mould and injection of flange wheel prototypes

The applicant will design whatever needed to be able to produce the flange wheel according to the final design of the part and outputs of task 3. If injection choosen, this step shall include rheological simulations. The applicant will manufacture the mould accordingly.

First flanges wheel prototypes will be manufactured and characterized with destructive and non-destructive technologies (e.g. tomography). The number of first flanges wheels will be defined by the

applicant but it should be sufficient:

- To check the thickness homogeneity (especially thickness flanges wheel walls),
- To check the position of the insert (if necessary),
- To control geometry and its compliancy with the defined design,
- To identify potential defects (porosity, fibres repartition, other defects). A specific protocol could be proposed to control the position of the reinforcement.

The design and process parameters will be modified and optimized according to the previous step.

This steps will be repeated as much as necessary to obtain a part compliant with the requirements (thickness homogeneity, geometry & no defect). This iterative process will be ended with the final definitions of the process and the design of the part.

When the process will be secured and optimized, the applicant will manufacture flange wheel demonstrators.

The applicant will propose a solution for an industrial process. An economic analysis will be done by the applicant.

Task 5: Characterization and testing of the flange wheel on the air cycle machine

The geometry of the demonstrators will be checked by the applicant with non-destructive technologies. A final demonstrator could be integrated in Air Cycle Machine, tested by the topic manager in specific test benches. The success of this task will ensure a TRL5 for the Topic Manager.

3. Major Deliverables/ Milestones and schedule (estimate)

*Type: R=Report, D=Data, HW=Hardware

Deliverables			
Ref. No.	Title - Description	Type*	Due Date
D1	Design of the flange wheel	R	M6
D2	Stress calculation Report	D	M9
D3	Process definition report	R	M9
D4	Design of the manufacturing tools	R	M12
D5	Quality control of the flange wheel and iteration	D + R	M22

Milestones (when appropriate)			
Ref. No.	Title - Description	Type*	Due Date
M1	Kick of Meeting	R	M0
M2	Manufacturing of first prototypes	HW	M20
M3	Integration of flange wheel in air cycle machine and test on the specific bench	R	M30

4. Special skills, Capabilities, Certification expected from the Applicant(s)

Essential:

- Extensive experience and strong knowledge on thermoplastic injection moulding (injection process, design and manufacturing of the moulds, calculation, rheological simulation)
- Strong knowledge on PEEK reinforced with short fibers and its manufacturing by injection moulding.
- Extensive experience and capabilities for characterizations (thickness homogeneity, geometry, identification of potential defects) by destructive and non-destructive technologies of reinforced thermoplastics



Advantageous:

- Facilities for implementing the processes in an industrial scale and ensuring aeronautical production rates.

5. Abbreviations

ECS	Environmental Control System
e-ECS	Electrical Environment Control System
ACM	Air Cycle Machine
PAEK	PolyAryl Ether Ketone
PEEK	PolyEther Ether ketone
PEKK	PolyEther Ketone Ketone
MoM	Minutes of Meeting

IV. JTI-CS2-2020-CFP11-SYS-02-63: Decentralised HVDC power conversion module for innovative optimised aircraft electrical network distribution

Type of action (RIA/IA/CSA):		IA	
Programme Area:		SYS	
(CS2 JTP 2015) WP Ref.:		WP 6.4	
Indicative Funding Topic Value (in k€):		750	
Topic Leader:	Airbus	Type of Agreement:	Implementation Agreement
Duration of the action (in Months):	30	Indicative Start Date (at the earliest)⁵⁶:	> Q4 2020

Topic Identification Code	Title
JTI-CS2-2020-CFP11-SYS-02-63	Decentralised HVDC power conversion module for innovative optimised aircraft electrical network distribution
Short description	
The purpose of this topic is to develop optimised prototypes in size, weight and cost for HVDC/DC conversion modules to be included in innovative, decentralized, electrical power distribution network on future large passenger aircraft. These modules will convert the main HVDC network voltage into secondary DC and AC voltages to supply dedicated end-users aircraft components or systems. The required modules will be developed according to the airframer specified modular concept. The modules will be brought to TRL5 via integration into airframer HVDC network integration bench.	

Links to the Clean Sky 2 Programme High-level Objectives ⁵⁷				
This topic is located in the demonstration area:		Electrical systems		
The outcome of the project will mainly contribute to the following conceptual aircraft/air transport type as presented in the scene setter:		Advanced Short/Medium-range		
With expected impacts related to the Programme high-level objectives:				
Reducing CO ₂ emissions	Reducing NO _x emissions	Reducing Noise emissions	Improving EU Competitiveness	Improving Mobility
<input checked="" type="checkbox"/>	<input type="checkbox"/>	<input type="checkbox"/>	<input checked="" type="checkbox"/>	<input type="checkbox"/>

⁵⁶ The start date corresponds to actual start date with all legal documents in place.

⁵⁷For further info see Chapter 1 “Introduction to the Programme Scene Setter / Objectives” with key technology themes / demonstration areas. Detailed information available in the CS2 Development Plan accessible via the Clean Sky JU Website and EC Participant Portal.

1. Background

The current aircraft distribution systems for power and data on current commercial passenger aircraft have some drawbacks in terms of weight, cost and manufacturing. A better optimised electrical power distribution system will rely on the distribution of less number of voltages over the A/C to avoid multiplication of routes which have a high impact on cost, weight and manufacturing. This implies in some area to recreate voltages required by some specific equipment, out of a primary distribution network.

To do so, some specific de-centralized (local) converters will be needed. Depending on the area of the aircraft, the main voltage can be different which means that several combinations of primary secondary voltages will have to be considered. In order to reduce this variability, a modular approach will be targeted.

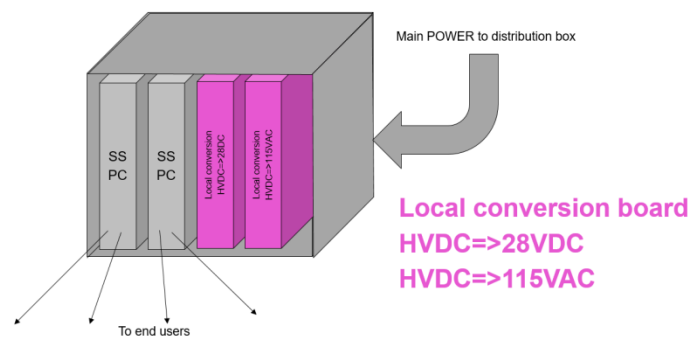

The main technical challenge of this call is to design and develop an High Voltage Direct Current conversion function, in a modular way, to sustain a hot environment with limited cooling capabilities (only passive).

As these modules may be installed in aircraft cabin, particular attention shall to be given to failure mode emissions containment.

Due to the high number of modules, it is important that the minimum cost is reached. This multicriteria approach should lead to an optimum that could become a standard module afterwards.

The developed conversion modules will be integrated in the airframer HVDC network management ground test demonstrator for TRL5 demonstration.

2. Scope of work

The objective of this topic is to define relevant requirements and to develop 2 prototypes of local voltage converters in order to achieve a maturity level TRL5, the minimum level of TRL required to start the project is TRL2.

The voltages conversion to be considered are :

- Prototype 1: HVDC to 28Vdc
- Prototype 2: HVDC to 115Vac

The sizing in current (ie power) will be the consequence of a trade between the available space, the thermal environment, the cost, and the real need, not known at the moment. It should anyway not exceed a power of 5kW.

These converters being decentralized in the aircraft, they will be air cooled with non-ventilated ambient air.

The expected contribution from the applicant consists in:

- a. Supporting the requirements definition at equipment level based upon requirements

- provided by the aircraft manufacturer
- b. Make a preliminary study on the feasibility of a modular approach between primary voltage and secondary voltage and infer the main requirement for each module.
- c. Design of the modules
- d. Design of related models, including a sizing/scaling capability (MBSE approach)
- e. Building & testing prototypes (hardware and software) for concept validation, operational and performance verification on applicant facilities, interfacing with aircraft systems models to be provided by the aircraft manufacturer
- f. Support the topic manager during the integration, tests and validation of the prototypes on the HVDC network integration bench and/or flight tests platform. The integration phase doesn't aim to use the prototypes for flight.

The A/C manufacturer will deliver a set of specifications to frame the work.

Non exhaustive list of specifications delivered by aircraft manufacturer:

- Required functions
- Packaging and interfaces (mechanical, connectors)
- cooling conditions
- software interfaces
- electrical network requirements

The prototypes will be integrated in a Systems ITD integration demonstrator that will encompass a distribution system based on distribution boxes containing the converters subject of this call.

The main Tasks expected from the applicant will be as follows:

- Task 1 Detailed project plan
 - A detailed project plan, including WBS, scope & schedule shall be established
- Task 2 Definition of requirements of the module
 - Requirements shall be defined at module level to support A/C and system requirements provided by the A/C manufacturer. In this phase could be agreed some evolutions of the A/C and system req. in order to reach better overall system efficiency
- Task 3 Preliminary study for modular concept
 - Study to define how to implement a modular approach in order to reduce combinatory of conversion.
- Task 4 Validation & verification plan
 - For each requirement a proposed means of compliance shall be defined for the validation & verification process.
- Task 5 Module definition:
 - System and components concept shall be defined to support the defined requirements
 - State of the art and review of available technologies.
 - Definition of potential solutions
- Task 6 Module detailed design
 - Detailed design of elementary bricks. Identification of the best way to generate several converters with reuse of generic bricks
- Task 7 Manufacturing of the building blocks prototypes
- Task 8 Building of the models that simulate the modules.
- Task 9 Validation and calibration of the building blocks – in supplier facilities
 - Can be done via testing or simulation
 - This phase will also encompass the calibration of the models defined in the task above
- Task 10 Final prototypes design:

- Assembly of the building blocks and integration in the final packaging.
- Task 11 Manufacturing of the final prototypes
- Task 12 Testing of the final prototypes – in supplier’s premises
 - Models update and validation
- Task 13 Integration and Testing in A/C environment – in A/C Manufacturer facilities
 - Delivery of prototypes and support to A/C Manufacturer for the integration and testing phase. This will be done the ground HVDC network demonstrator.

Tasks		
Ref. No.	Title - Description	Due Date
Task 1	Detailed project plan	T0+2M
Task 2	Definition of requirements of the module	T0+3M
Task 3	Preliminary study for modular approach	T0+5M
Task 4	Validation & verification plan	T0+7M
Task 5	Module definition	T0+7M
Task 6	Module detailed design	T0+10M
Task 7	Manufacturing of the building blocks prototypes	T0+15M
Task 8	Building of the models that simulate the modules.	T0+15M
Task 9	Validation and calibration of the building blocks – in supplier facilities	10+19M
Task 10	Final prototype design	T0+21M
Task 11	Manufacturing of the final prototype	T0+24M
Task 12	Testing of the final prototype – in supplier’s premises Models update	T0+26M
Task 13	Integration and Testing in A/C environment – in A/C Manufacturer facilities	T0+30M

3. Major Deliverables/ Milestones and schedule (estimate)

*Type: R=Report, D=Data, HW=Hardware

Deliverables			
Ref. No.	Title - Description	Type*	Due Date
D1	Project plan	R	T0+2M
D2	System Requirement Document	R	T0+3M
D3	Report on modular approach and definition of the techno bricks	R	T0+5M
D4	Validation & Verification Plan	R	T0+7M
D5	Module Definition Document. Description of the potential concepts	R	T0+10M
D6	Validation prototypes	HW	T0+15M
D7	Models of the modules	D	T0+15M
D8	Module Validation & verification Report	R	T0+19M
D9	Full scope verification prototype and associated models	HW +D	T0+24M
D10	Full scope System Validation & verification Report	R	T0+27M
D11	Models of the module with updated parameters	D	T0+27M
D12	Full scope verification prototype – delivery to A/C manufacturer for testing	HW	T0+27M
D13	Final report	R	T0+30M

Milestones (when appropriate)			
Ref. No.	Title - Description	Type*	Due Date
M1	Preliminary Design Review - System High Level Requirements	PDR	T0+7M
M2	Design Review - Review of the trade-offs, definition of the system architecture to be tested	DR	T0+19M
M3	TRL4	R	T0+19M
M4	Test Readiness Review	TRR	T0+23M
M5	TRL5	R	T0+27M

4. Special skills, Capabilities, Certification expected from the Applicant(s)

Essential:

- Long experience and skills in the design and manufacture of electrical conversion systems for the aerospace industry.
- Knowledge and experience of various voltages used on aircrafts and on HVDC design constraints
- Capacities to develop both hardware and software including mechanical, racking & cooling constraints
- Experienced in modelling and simulation, MBSE
- Working prototypes (even at low maturity level) demonstrated of one or several building blocks of the targeted system

Advantageous:

- Existing experience of natural convection cooling rackable modules

5. Abbreviations

PDR	Preliminary Design Review
DR	Design Review
TRR	Technical Readiness Review
HVDC	High DC Voltage (+/- 270V)
A/C	Aircraft

V. JTI-CS2-2020-CFP11-SYS-02-64: Human Safe HVDC Interconnection components

Type of action (RIA/IA/CSA):		IA	
Programme Area:		SYS	
(CS2 JTP 2015) WP Ref.:		WP 6.4	
Indicative Funding Topic Value (in k€):		800	
Topic Leader:	Airbus	Type of Agreement:	Implementation Agreement
Duration of the action (in Months):	30	Indicative Start Date (at the earliest)⁵⁸:	> Q4 2020

Topic Identification Code	Title
JTI-CS2-2020-CFP11-SYS-02-64	Human Safe HVDC Interconnection components
Short description	
<p>The objective of this topic is to develop innovative wiring sets (cables, contact and connector) based upon agreed requirements according to dedicated use cases, able to sustain new electrical constraint appearing with HVDC networks, during installation, operation and maintenance with a particular attention to human protection against electrical shock in case of cable damages or disconnection of a powered line. The activities will cover the design, development, prototyping and necessary tests for pre-qualification of the components. The components will be integrated and tested in HVDC network demonstrator.</p>	

Links to the Clean Sky 2 Programme High-level Objectives⁵⁹				
This topic is located in the demonstration area:		Electrical Systems		
The outcome of the project will mainly contribute to the following conceptual aircraft/air transport type as presented in the scene setter:		Advanced Long-range Advanced Short/Medium-range		
With expected impacts related to the Programme high-level objectives:				
Reducing CO₂ emissions	Reducing NO_x emissions	Reducing Noise emissions	Improving EU Competitiveness	Improving Mobility
<input checked="" type="checkbox"/>	<input type="checkbox"/>	<input type="checkbox"/>	<input checked="" type="checkbox"/>	<input type="checkbox"/>

⁵⁸ The start date corresponds to actual start date with all legal documents in place.

⁵⁹For further info see Chapter 1 “Introduction to the Programme Scene Setter / Objectives” with key technology themes / demonstration areas. Detailed information available in the CS2 Development Plan accessible via the Clean Sky JU Website and EC Participant Portal.

1. Background

Current aircrafts electrical distribution networks embed 28V DC, 115V AC and most recently 230V AC. Electrical systems equipment are connected to these networks, or interconnected together thanks to the EWIS (Electrical Wire Interconnection System) Standard Parts, such as cables, contacts and connectors compatible with those level of voltage.

In the Frame of Clean Sky 2 ITD Systems, several initiatives have been launched to study systems working under HVDC (High Voltage Direct Current) in WP5 and WP6 in terms of generators, power management centers and loads, but cable and connection device HVDC compatibility has not been addressed yet, particularly important for the HVDC demonstration completeness. Interconnection of HVDC equipment shall be done with HVDC electrical components.

The Airbus Ground test bench PROVEN will be used to provide the HVDC network integration frame, to test the aircraft HVDC generation, distribution and loads.

With increase of Voltage, it is expected new phenomena to be mastered, leading to new technological choices in material and building process of the interconnection components.

This will allow further exploitation onto the More Electrical single aisle passenger aircraft.

The framework of this Call for Partner is the ITD Systems WP6.4 "Major loads – Integrated demonstration and validation"

2. Scope of work

The objective of this Call for Partner is to develop several wiring sets (cables, contact and connector) based upon agreed requirements according to dedicated use cases, able to sustain new electrical constraint appearing with HVDC with a particular attention to human protection against electrical shock in case of cable damages or disconnection of a powered line.

It is expected a cable, connectors and contacts concept to be defined and developed, applied for the demonstration to a few different gauges and rating sets.

The wiring set shall be designed to cope with HVDC (500V to 1kV), „flat” or Pulse Width Modulated.

The wiring set shall be designed to comply with passenger aircraft environmental conditions, such as temperature (-55°C to 200°C), pressure (from 145mbar to 1045mbar), exposed area (water, fluids, dust, sand, lightning indirect effect) etc.

More details will be provided by the topic manager, through a technical specification, at the beginning of the project.

Failure, default, degradation predicting system and protection device for standard part components is foreseen.

The safety device, system, layer or mechanism has to be innovative, compact and lightweight in order to be integrated in the Standard Parts.

The activities of this Call will cover the design, the development, the prototyping and necessary tests for pre-qualification of the components. This project is intended to cover maturity progression from existing TRL3 to targeted TRL5/6. The delivered components will be integrated and tested in HVDC network demonstrator set-up by Airbus in the frame of the WP 6.4 of the ITD SYS, with the support of the applicant.

In addition, it shall be considered the manufacturing and provision of a set of cables and connectors to be used for dedicated use case in flight.

Expected main contributions of the applicant is to:

- Define products (cable, contact, connector) according to the Airbus technical specification.
- Define requirement for a monitoring and failure predicting system (either active or passive system) to be integrated into components. System shall detect early ageing due to several

constraints (electrical ageing, (partial discharges, spaces charges, etc.) but also other causes such as damages caused during installation)

- Manufacture prototypes and test them in applicant's facility in order to confirm compliance with requirements and compatibility with cable, contact and connector (TRL4)
- Provide prototypes (cable, contact, connector with integrated safety system) and support Airbus for integration tests on Airbus demonstrator and validation (PROVEN Airbus ground test facility) (TRL5)
- Run necessary tests in line with normative references in order to prequalify the products as preparation of TRL6, at applicant's facility.

The tasks requested to the applicant(s) are the following ones:

Task 1 Detailed project plan : To create a detailed project plan, including WBS, OBS, scope & schedule shall be established.

Task 2 Electrical Ageing Synthesis : To provide a synthesis of state of the art about electrical signs of failure, default, degradation of a component (such as cable, connector and contact) signs and way to detect them (lesson learnt from TRL ≤ 3)

Task 3 Definition of requirements : To elaborate the technical specification of the failure, default, degradation predicting system; about its integration within the components (cables, contact, connector) and about integration in a larger monitoring system.

Task 4 Validation & Verification plan : To build a compliance matrix in order to identify means of verification for all requirements of the electrical components (cable, connector, contact) and the monitoring & failure predicting system technical specification.

Task 5 Products Design : To design the products (cables, contacts, connectors, and integrated monitoring and failure predicting system) in order to meet all requirements from the product Airbus technical specification and all requirements related to protection system described in task 3. They shall be innovative in their building and/or in the material used and assembled together. Innovation in the products and the systems compared to common technology shall be highlighted during design phase.

Task 6 Product concept validation : To assess and validate the products compliance to the requirements by analysis and/or tests:

- a) Requirement compliance validation by analysis
- b) Requirement compliance validation by test on prototypes in partner facilities
- c) Trade-off and selection of the most appropriate solutions

Task 7 Product integration validation : To refine and verify the final selected products/systems with integration test on a demonstrator(s).

- a) Building prototype for installation integration test
- b) Building prototype for integration test on Airbus functional demonstrator "PROVEN"
- c) Support Airbus during integration tests

The expected maturity level for the final prototype is TRL5.

Task 8 Product pre-qualification : To prequalify the products by performing standard ageing and environmental tests plus a set of new tests to be defined specifically for HVDC. Those tests will be ran on

Partner's facilities.

The expected maturity level for the final product is TRL6.

Task 9 Final Report: To Formalize all results in the final report.

Tasks		
Ref. No.	Title - Description	Due Date
Task 1	Detailed project plan	T0 to T0+3 months
Task 2	Electrical Ageing Synthesis	T0 to T0+3 months
Task 3	Definition of requirements	T0 + 6 Months
Task 4	Validation & Verification plan	T0 + 9 Months
Task 5	Products Design	T0 + 12 Months
Task 6	Product concept validation	T0 + 19 Months
Task 7	Product integration validation	T0 + 28 Months
Task 8	Product pre-qualification	T0 + 28 Months
Task 9	Final Report	T0 + 30 Months

3. Major Deliverables/ Milestones and schedule (estimate)

*Type: R=Report, D=Data, HW=Hardware

Deliverables			
Ref. No.	Title - Description	Type	Due Date
D1	Project plan	Document	T0 + 3 Months
D2	Electrical Ageing Synthesis	Document	T0 + 6 Months
D3	Integrated monitoring and failure predicting system requirements and technical specification	Document	T0 + 6 Months
D4	Compliance matrix. Means of verification and validation	Document	T0 + 9 Months
D5	Product definition dossier	Document	T0 + 12 Months
D6	Prototype for concept validation (TRL4)	Prototype	T0 + 15 Months
D7	Prototypes for integration tests (TRL5)	Prototype	T0 + 21 Months
D8	Integration tests reports	Document	T0 + 29 Months
D9	Pre-qualification test plan	Document	T0 + 13Months
D10	Pre-qualification test report (TRL6)	Document	T0 + 30 Months

Milestones			
Ref. No.	Title - Description	Type	Due Date
M1	Preliminary Design Review Validation of design concept(s). Presentation of first draft of preliminary qualification test plan.	Document	T0 + 9 Months

Milestones			
Ref. No.	Title - Description	Type	Due Date
M2	Technical Readiness Review Review of concept proposals; compliance to Freeze of one or several design concept(s). Go for prototyping. Definition dossier available (including PBS and drawings). Validation of preliminary qualification tests plan	Document	T0 + 12 Months
M3	Prototype for integration test	Prototype	T0 + 20 Months
M4	Integration test report	Document	T0 + 30 Months
M5	Pre-qualification test Report	Document	T0 + 30 Months

4. Special skills, Capabilities, Certification expected from the Applicant(s)

Essential:

- Strong experience in Aeronautical electrical connectors and contacts
- Strong experience in electrical component working under at least 500V DC
- High knowledge about HVDC arc phenomena, electrical ageing under HVDC (PWM included) and mechanical protection for human operators
- High knowledge in early ageing sign detection and preventing method/system (having reached TRL 3)
- Already having a Technology Readiness Level 3 in the interconnection components described in this topic.

5. Abbreviations

HVDC	High Voltage Direct Current (meaning from 500VDC to 1000 VDC; flat or PWM)
EMI	Electro Magnetic Interference
PWM	Pulse Width Modulation
TRL	Technology Readiness level

VI. JTI-CS2-2020-CFP11-SYS-03-25: Investigation and modelling of hydrogen effusion in electrochemically plated ultra-high-strength-steels used for landing gear structures

Type of action (RIA/IA/CSA):		RIA	
Programme Area:		SYS	
(CS2 JTP 2015) WP Ref.:		WP 100.2	
Indicative Funding Topic Value (in k€):		1000	
Topic Leader:	Liebherr	Type of Agreement:	Implementation Agreement
Duration of the action (in Months):	28	Indicative Start Date (at the earliest)⁶⁰:	> Q4 2020

Topic Identification Code	Title
JTI-CS2-2020-CFP11-SYS-03-25	Investigation and modelling of hydrogen effusion in electrochemically plated ultra-high-strength-steels used for landing gear structures
Short description	
The aim of this project is to understand the underlying phenomena and create a verified model of the influence of undesirable layer structures of electrochemically deposited corrosion protection layers of ultra-high-strength-steel parts on hydrogen degassing. This shall allow predicting the remaining hydrogen concentration in steel parts and the probability for hydrogen embrittlement. The industrial objective is to minimise rework and scrap of ultra-high-strength-steel parts and the related environmental impacts.	

Links to the Clean Sky 2 Programme High-level Objectives⁶¹				
This topic is located in the demonstration area:		Eco Design		
The outcome of the project will mainly contribute to the following conceptual aircraft/air transport type as presented in the scene setter:		Advanced Long-range Advanced Short/Medium-range		
With expected impacts related to the Programme high-level objectives:				
Reducing CO₂ emissions	Reducing NO_x emissions	Reducing Noise emissions	Improving EU Competitiveness	Improving Mobility
<input checked="" type="checkbox"/>	<input type="checkbox"/>	<input type="checkbox"/>	<input checked="" type="checkbox"/>	<input type="checkbox"/>

⁶⁰ The start date corresponds to actual start date with all legal documents in place.

⁶¹For further info see Chapter 1 “Introduction to the Programme Scene Setter / Objectives” with key technology themes / demonstration areas. Detailed information available in the CS2 Development Plan accessible via the Clean Sky JU Website and EC Participant Portal.

1. Background

The use of ultra-high-strength (UHS)-steels for highly stressed parts such as landing gear (see Figure 1) primary load-path structures contributes to the creation of ever lighter and therefore more energy-efficient aircraft. Due to its enormously high strength, with comparably high toughness, UHS-steel is the most resource-efficient material for achieving a relatively light component that can withstand the highest loads, such as those that occur during take-off and landing. By saving weight in the construction and operation of such components, the environmental balance is improved at the same time.

A disadvantage of UHS-steels, however, is their high susceptibility to corrosion. For this purpose, the components are provided with an active corrosion protection which usually consists of a metallic, electrochemically applied corrosion protection plating.

The advantage of electrochemical application lies in the economic possibility of being able to apply very thin but highly effective metal layers at comparably low process temperatures. A disadvantage of electrochemical plating of UHS-steel, however, is the possibility of hydrogen embrittlement. This results from the high susceptibility of UHS-steels to atomic hydrogen, which is always inherent in the electrochemical plating process. Hydrogen embrittlement can lead to dangerous reductions of the material's ability to withstand the design loads. Landing gear components might fail at hard landings or over the life-time. Remaining hydrogen in the steel is therefore posing a safety-threat to aircraft.

The hydrogen hazard potential is effectively countered by specific measures. One measure is the special process control of the plating processes, as so called "Low Hydrogen Embrittlement processes", reducing the quantity of hydrogen in the first place. The other key measure to prevent hydrogen embrittlement is the subsequent degassing – technique to let the unavoidable hydrogen exit the material). The plated component is heated for a certain time to expel the hydrogen that was absorbed during the plating. The plating that has been brought onto the surface during the surface treatment plays an important role in this diffusion-controlled process of hydrogen effusion.

On the one hand, the diffusion and storage ability for hydrogen of the plating material is important. On the other hand, the (macroscopic) layer characteristics/layer shape, the so called layer morphology, has a considerable influence on the degassing capability. The more fissured and globular the layer structure is, the lower the effusion paths are and the greater the probability that the hydrogen will effuse and can no longer be harmful to the component (see Figure 2).

The layer morphology produced by electrochemical deposition depends on several factors and can locally vary greatly. The differences mainly result from local geometric influences, such as a different applied electric field and different electrolyte flow conditions during plating. Low local current densities, as well as strong direct electrolyte flow usually lead to a more compact, closed layer, which has a worse degassing behaviour than a fissured, globular layer. If plating leads to areas with a compact, closed layer morphology, the parts have to be removed from the production and replated again.

Simply put, whenever an area of the corrosion protection layer does not have the right characteristics, the required degassing process will likely fail. However there is no way of knowing the real result of the degassing process.

That is why in those cases, state-of-the-art procedure for the safety critical UHS components is to completely strip-off the corrosion protection layer and to repeat the galvanic process. In rare events the entire component will need to be scrapped because of the uncertainty of dangerous hydrogen presence.



Figure 1:
A350 Nose Landing Gear
with Main Fitting and
Sliding Tube made of
300M UHS
© Liebherr Aerospace

For landing gear parts this implies considerable use of additional energy and chemicals or even the loss of the very energy intense part (for example: Energy for a 1.5t forging part for a main fitting, machining of 80% of the material, heat treatments and other processes as well as the coatings that cause the problem will be lost).

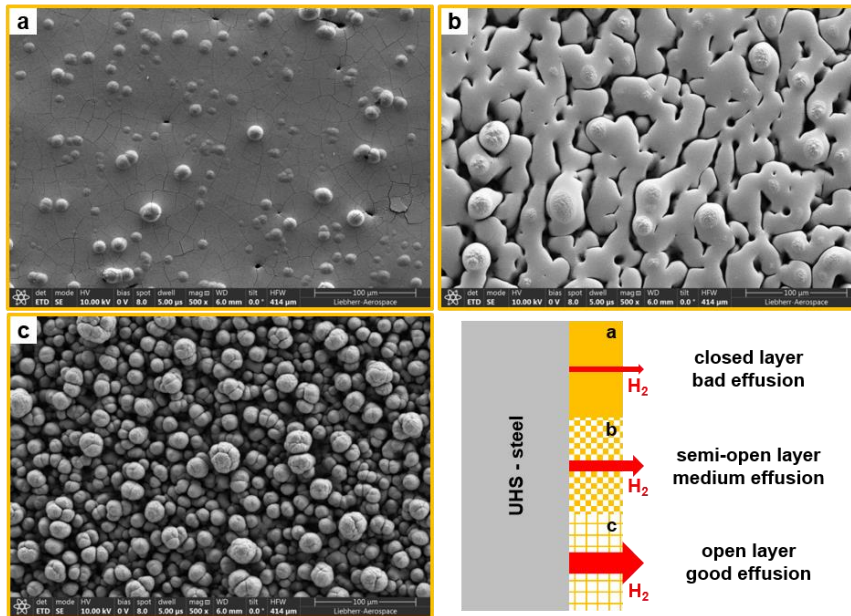

Figure 2: Schematic view of the basic relationship between hydrogen effusion (H₂) and layer morphology using the example of a) a closed-, b) a semi-open- and c) an open layer structure.

In order to avoid this material and energy consuming way of dealing with the problem, detailed knowledge of the correlation between layer structure and degassing is required. The question to be answered is what degree of layer compactness and what maximum expansion of a compact layer does impair degassing negatively. Furthermore, it has to be answered with which subsequent measures the adverse effects on degassing can be eliminated and how exactly they need to be carried out. Currently, there is little known about the exact behaviour of hydrogen inside the material and in particular inside different treatment layers. This will require some theoretical and practical basic research as starting point.

The aim of this Topic is to develop a model to simulate the influence of the layer morphology of electrochemically produced LHE-ZnNi and LHE-Cd layers on the hydrogen effusion behaviour during degassing. The model should be able to make reliable predictions in order to be able to minimise environmentally affecting rework in the future. Therefore the model needs to be verified by relevant testing. Finally, the result shall be converted into practical guidance to be used during production, including a method to effectively identify the morphology of the layers.

In addition, this investigation could serve as a starting point for process-specific reduction of the soak time (degassing time) of the resource-intensive degassing step. For this purpose, discussion with standardisation bodies is planned to be initiated. For reasons of clarity, it is not the objective to find measures to avoid or reduce incorrect layers, but to deal with their impact when they occur.

2. Scope of work

The following tasks are envisaged:

Tasks		
Ref. No.	Title - Description	Due Date
Task 1	Define the necessary investigations for the creation of a realistic computer-based simulation model and produce the corresponding test specimens.	T0+7
Task 2	Conduct tests to develop and validate a computer-based simulation model for description of the hydrogen effusion characteristics of compact, electrochemically generated layer morphologies.	T0+15
Task 3	Check the material dependency of the computer-based simulation model with further base materials and make adjustments to the model if necessary.	T0+20
Task 4	Bring the results of the computer-based simulation model to application maturity.	T0+28

Task 1 – Define the necessary investigations for the creation of a realistic computer-based simulation model and produce the corresponding test specimens.

At the beginning of the project, the Topic Manager (TM) will share with the applicant detailed information regarding to the plating processes and the degassing procedure, to support the definition of the requirement for the tests, which will support the investigations that the applicant has planned to create the model.

Several layer base material combinations shall be investigated. The plating systems to be studied are electrochemically deposited LHE-Zinc-Nickel and LHE-Cadmium. The corresponding base materials to be plated are to be agreed between TM and applicant. A selection of materials most used by the TM is given in the table below (order of relevance for the products). Equivalent materials deviating from the table can be used alternatively after consultation between TM and applicant. A minimum of four different base-materials shall be investigated in total.

Materials proposed for investigation	Plating processes for investigation
<ul style="list-style-type: none"> • 300M • Custom 465 • E35NCD16H • SAE 4340 • PH13-8Mo • EZ2NKD18 	<ul style="list-style-type: none"> • LHE-Zinc-Nickel • LHE-Cadmium

The electrolyte solutions for plating the test specimens are provided by the TM. The plating will be carried out by the applicant in close coordination with the TM. The material required for the test specimens can also be provided by the TM, but only to a limited extend. The procurement of the material by the applicant is therefore preferred.

The investigations to obtain the necessary data for the computer-based material simulation model must be defined. It must be ensured that all necessary parameters, such as hydrogen trapping effects, permeation- and desorption characteristics, are collected so that the computer-based simulation model to be created is able to fully answer the questions posed in Task 2.

Before any investigation, the electrochemically generated layers on the respective materials must be

examined and characterized with regard to their different possible layer morphologies. TM and applicant have to define together with which layer morphologies the development will be carried out.

Task 2 – Develop and validate a computer-based simulation model to describe the hydrogen effusion characteristics of compact, electrochemically generated layer morphologies.

On the basis of one material agreed between TM and applicant, the study concept from Task 1 is to be tested with both plating systems. The tests and examinations to be carried out have to be optimized and any necessary changes to the concept shall be identified for further improvement.

The conducted tests shall lead to a realistic computer-based material simulation model with which it will be possible to avoid resource-intensive rework due to compact layer structures.

Key aspects shall be investigated as layer characteristics in order to avoid a negative effect on hydrogen degassing, measures to be taken (after the plating deposition) to eliminate the adverse effects of compact layers on degassing.

The application may identify further questions/factors that need to be investigated according its knowledge and expertise.

The basis for the standard degassing parameters as reference point is the international standard SAE AMS 2759/9.

The computer-based simulation model must match reality. Appropriate evidence of the validity of the model must be provided.

Task 3 – Check the material dependency of the computer-based simulation model with further base materials and make adjustments to the model if necessary.

The hydrogen effusion characteristics of compact, electrochemically generated layers will be investigated on further materials agreed between TM and applicant and compared with the computer-based material simulation model developed and validated in Task 2. Here it shall be shown whether there is a base metal influence/bias on the degassing characteristics of different layer morphologies.

All tests and examinations shall be conducted on a minimum of further three materials in combination with both layer systems.

If a material dependency exists which is not described by the developed computer-based simulation model from Task 2, the simulation model has to be adapted, or a further model has to be developed.

The computer-based simulation model (or models, if necessary) must be able to represent realistically all combinations of layer systems and base materials.

Task 4 – Bring the results of the computer-based simulation model to application maturity.

The aim is to create simple rules / formulas for the handling of compact layer morphologies of electrochemically plated UHS-steels during serial manufacturing. These simple rules / formulas must provide clear criteria in which cases a compact layer impair with standard degassing or not. Furthermore, these simple rules / formulas must give clear instructions on how a reduced degassing effect can be negated afterwards, e.g. by extending the soak time depending on the area expansion of the compact layer. The rules / formulas must be suitable for standardization with the TM's organisation. To enable the practical application of the rules / formulas, in addition, a reliable method for the characterization of electrochemically generated layer structures shall be developed.

The method must be suitable to be applied on large plated components in the production environment, even at curved surfaces including inner diameters. The execution of the method must be suitable to be carried out by ordinary operating personnel.

The TM is open to any practical solution proposed by the applicant, ranging from improved state-of-the-art to new matured concepts. Even if independent in principle, the TM expects important synergies of tests for this development with the model verification tests.

The Topic Manager is considering the possibility to share the results with international standardisation-bodies in order to optimise degassing processes for the entire industry. E.g. in case of sufficient evidence, the duration of heating (currently up to 23 hours at about 190 °C acc. to AMS2759/9) could be reduced, leading to a global decrease in energy consumption. Therefore, application's experience with standardisation and its possible collaboration is highly welcomed.

3. Major Deliverables/ Milestones and schedule (estimate)

*Type: R=Report, D=Data, HW=Hardware

Deliverables			
Ref. No.	Title - Description	Type*	Due Date
D1	Definition of required examinations and test specimens. (Task 1)	R	T0+2
D2	Results of completed investigations acc. Task 2.	R	T0+11
D3	Computer-based model to simulate the effusion of hydrogen depending on characteristics of corrosion protection layers (Task 2)	D	T0+13
D4	Results of investigations with further UHS-steel base materials acc. Task 3.	R	T0+19
D5	Practical rules/formulas derived from the computer-based material simulation model to be applied in a production environment (Task 4)	R	T0+22
D6	Description of an operational measuring method for the characterization of layer morphologies on large parts. (Task 4)	R	T0+24
D7	Description of verified method(s) to characterise the protection layers on large parts in serial production (Task 4)	R	T0+25

Milestones			
Ref. No.	Title – Description	Type*	Due Date**
M1	All required test specimens manufactured. (Task 1) Note: Excluding the electrochemical plating.	HW	T0+7
M2	Conformity of the computer-based model with reality is validated. (Task 2) (Review)	R	T0+15
M3	Investigation results from further base materials (Task 3) match the validated computer-based simulation model (Review).	R	T0+20
M4	Derived rules / formulas for standardization of TM's processes are considered mature for implementation (Task 4 (Review))	R	T0+27

4. Special skills, Capabilities, Certification expected from the Applicant(s)

Essential

- Strong knowledge and experience in the development of computer-based material simulation models.
- Strong materials science knowledge of ultra-high-strength steel in connection with hydrogen embrittlement.
- Knowledge about electrochemical plating and hydrogen kinetics.
- Capabilities required to perform the study:
 - Optical microscope, SEM-EDX, FIB and any other plating structure analysis methods that will be relevant to characterise layer morphologies

- Laboratory for metallographic preparation
- Hydrogen analysis equipment, such as melt extraction, TD-MS, or permeation cell, which is necessary to generate the required data to create and validate the simulation model
- Hardware and associated software for the development of complex computer-based material simulation models
- Laboratory or facility for electrochemical plating of the test specimens

Advantageous:

- Facilities for the production of the test specimens made of ultra-high-strength steels
- Eco design approach

5. Abbreviations

AMS	Aerospace Material Specifications
FIB	Focused Ion Beam
LHE	low hydrogen embrittlement
SAE	Society of Automotive Engineers
SEM-EDX	Scanning Electron Microscope with Energy Dispersive X-Ray
TD-MS	Thermal Desorption with Mass Spectrometry
UHS	Ultra-high-strength

VII. JTI-CS2-2020-CFP11-SYS-03-26: Replacement of cobalt in Environmental Control System bleed valves

Type of action (RIA/IA/CSA):		IA	
Programme Area:		SYS	
(CS2 JTP 2015) WP Ref.:		WP 100.2	
Indicative Funding Topic Value (in k€):		750	
Topic Leader:	Liebherr Toulouse	Type of Agreement:	Implementation Agreement
Duration of the action (in Months):	24	Indicative Start Date (at the earliest)⁶²:	> Q4 2020

Topic Identification Code	Title
JTI-CS2-2020-CFP11-SYS-03-26	Replacement of cobalt in Environmental Control System bleed valves
Short description	
The project aims to study new nickel self-fluxing alloys and their elaboration routes for the bleed valves butterfly in replacement of cobalt alloy. This project will help to overcome health potential issues regarding wear particles of cobalt alloys in cabin air, but also the need of a higher wear resistant sealing rings and leakage free valve in new hotter and more pressurized bleed air for the future engines and the future less bleed Environmental Control Systems.	

Links to the Clean Sky 2 Programme High-level Objectives⁶³				
This topic is located in the demonstration area:		Eco-design		
The outcome of the project will mainly contribute to the following conceptual aircraft/air transport type as presented in the scene setter:		Advanced Short/Medium-range		
With expected impacts related to the Programme high-level objectives:				
Reducing CO₂ emissions	Reducing NO_x emissions	Reducing Noise emissions	Improving EU Competitiveness	Improving Mobility
<input checked="" type="checkbox"/>	<input type="checkbox"/>	<input type="checkbox"/>	<input checked="" type="checkbox"/>	<input type="checkbox"/>

⁶² The start date corresponds to actual start date with all legal documents in place.

⁶³For further info see Chapter 1 “Introduction to the Programme Scene Setter / Objectives” with key technology themes / demonstration areas. Detailed information available in the CS2 Development Plan accessible via the Clean Sky JU Website and EC Participant Portal.

1. Background

The future UHBR engine will provide hotter and higher pressure air flow to the bleed valves (shown in blue). The internal parts directly exposed to this flow will have to sustain higher temperatures. This project addresses a challenge linked to the future UHBR engines and is foreseen in the Eco-Design demonstration area.

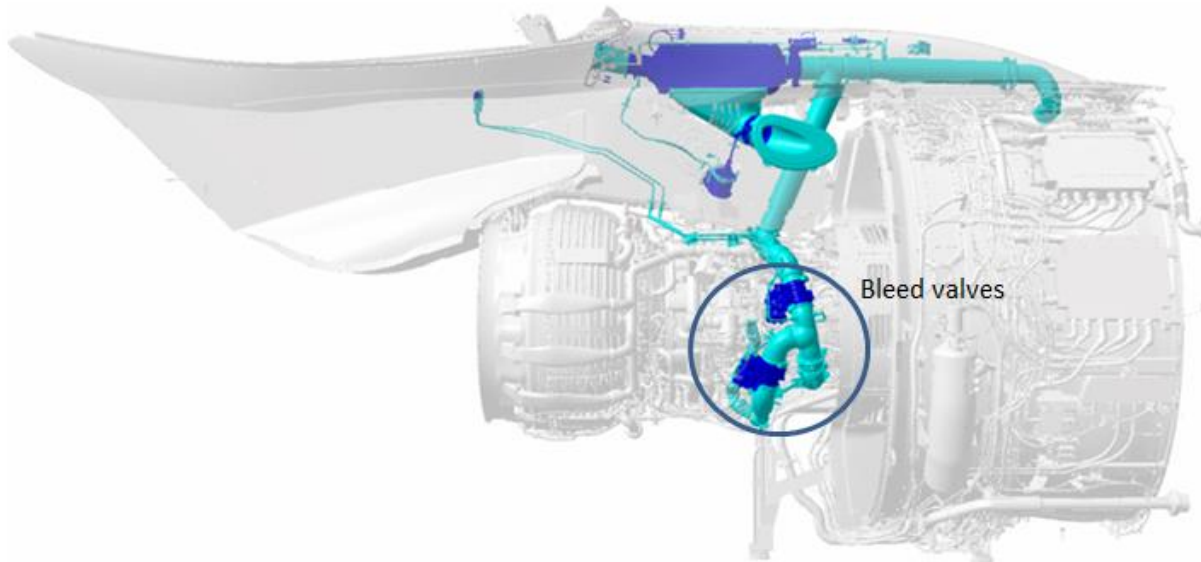

High temperature butterfly valves have to ensure a limited internal leakage in order to avoid pressure build-up in the bleed pipes. To compensate this pressure build-up, pressure relief holes are sometimes necessary in the bleed pipes. The Topic Manager currently uses cobalt alloy like stellite 6 for the manufacturing of the butterfly sealing rings that slide against a hard chromium coating or a tungsten carbide-cobalt coating.

High temperature wear of sealing under complex thermomechanical stresses leads to bleed valve internal leakage increase: in fact, thermal gradients and pressure leads to the loss of cylindrical shape of the valve body as shown in the figure below.

These phenomena lead to 3 wear areas presented on the three micrographs below:

- Zone 1: sealing rings wear against the valve body
- Zone 2: sealing rings wear against the machined groove of the butterfly
- Zone 3: sealing rings wear against the corrugated stiffener

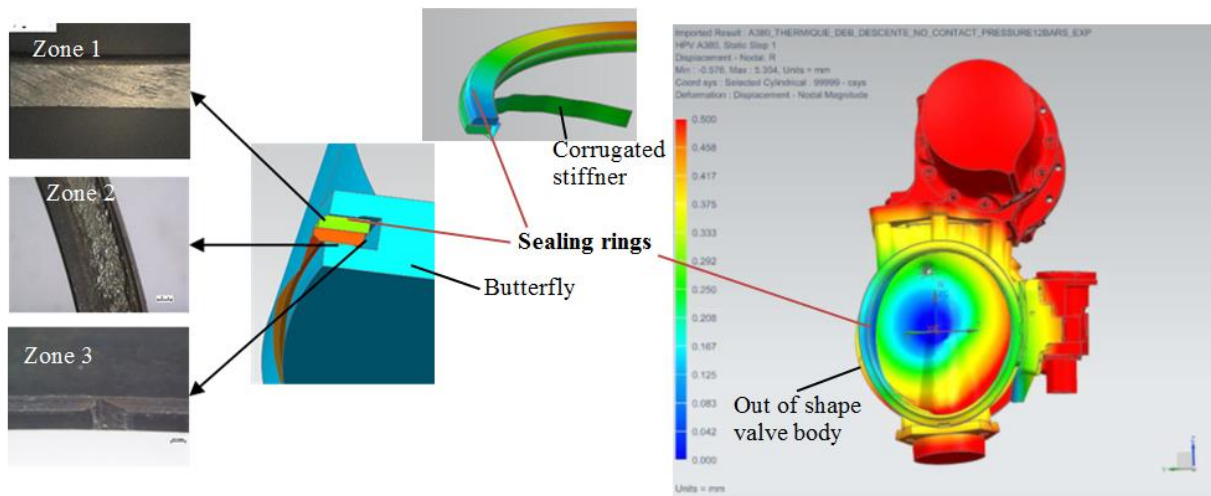

Within the scope of a Less Bleed ECS, the suppression of these pressure relief holes is foreseen in order to limit bleed flow taken on the engine. The limitation of leakage and the suppression of pressure relief holes per valve will result in a reduction of fuel consumption of about 1.8 kg/h for small-medium range aircraft as a benefit of the project. In this context, the applicants will have to develop an innovative new solution to ensure very low leakage under high pressure delta and high temperatures.

Moreover, the Topic Manager would like to avoid cobalt oxidized wear particles in the air flow to the cabin in order to increase the cabin air quality. The presence of wear particles of cobalt alloys in cabin air could represent health issues with carcinogenic risks.

For high temperature wear resistant applications, cobalt alloys are presented as a conventional solution, but the Topic Manager would like to study a category of nickel alloys like NiCrFeSiB Self-Fluxing alloys that exhibit excellent corrosion, and are reported to be wear-resistance up to 600°C. They also demonstrate an excellent oxidation resistance up to melting range, and satisfactory resistance to some organic acids.

From manufacturing point of view, these alloys could be machined and they have a wide melting range allowing them especially to be manufactured by casting or by powder welding processes like cladding or direct metal deposition. In that case, the literature results revealed that the laser power had a considerable influence on the wear resistance of NiCrSiFeB coatings.

To reach this objective the main scientific aspects to study are:

- Parametrical study of elaboration process by casting and direct metal deposition
- Tribological characterization under complex thermomechanical loads : determination of wear rate and wear particles characterization (shapes, sizes and composition) in order to provide data for a toxicity analysis

This project will help the Topic manager to anticipate future regulation law concerning cabin air quality, justifying the need for a life cycle analysis of the foreseen solution.

2. Scope of work

The project is divided in different tasks that will help to reach this objective.

Tasks		
Ref. No.	Title - Description	Due Date
Task 1	Definition of the requirements	T0+3
Task 2	Processes study	T0+18
Task 3	Metallurgical and Tribological Characterization	T0+20
Task 4	Life cycle analysis and Toxicity Characterization	T0+24
Task 5	Selection for Demonstration	T0+24

Task 1: Definition of the requirements

At the beginning of the project, the Topic manager will define the following requirements:

- Detailed application and thermomechanical behaviour of the sealing rings; data on existing solutions and their limits will be provided : materials and coating solutions, design data
 - o The current solution is based on two juxtaposed sealing rings made by centrifugal casting in stellite 6. They are placed in a machined groove in the valve butterfly and a corrugated stiffener is placed under the sealing rings to help them to stay in contact with the valve body. The internal area of the valve body is coated with hard chromium or tungsten carbide cobalt.
- max temperature and temperature pattern foreseen for the bleed valves in the future engines like UHBR

Based on these data, the applicant will define in collaboration with the Topic Manager the two or three best grades and composition of self-fluxing nickel alloys.

Task 2: Processes study

Potential materials are mainly available for thermal spraying. To have a competitive product, the manufacturing process should avoid metal scrapping and intensive machining.

The partners will have to study elaboration of cylinders with the two or three selected materials by:

- Centrifugal casting.
- Direct Metal Deposition

Different samples will be realized: cylinders and tubes. The cylinders will have the same diameter of 4 inches as the final sealing rings. Machinability or capacity to be grinded will be evaluated. The various samples for Task 3 will be realized by the applicants at the end of this Task.

Task 3: Metallurgical and tribological characterization

The microstructure and hot hardness will have to be checked and compared to the current solution of stellite 6 made by centrifugal casting. This task will support the process development of task 2 in order to reach TRL5. Based on the hardness and microstructure quality, the applicant will select 3 or 4 solutions to be tested on tribometers. A solution is defined by one material composition associated to one consolidation process. 2 or 3 samples of each solution will be tested.

Tribological tests of reciprocating sliding under high temperature (650°C) will be performed by the applicants and the solution will be compared with stellite 6 samples provided by the Topic Manager. Tribological properties will be jointly characterized and analysed with the Topic Manager.

Optimization loop will be necessary between Task 2 and Task 3 to select the best wear resistant

Task 4: Life cycle analysis and preliminary toxicity characterization

The applicants shall perform a comparative life cycle analysis between centrifugal casting and direct metal deposition for tubes elaboration with self-fluxing nickel alloys and centrifugal casting of current stellite 6. The objective is to select the process that presents the less impacts.

The wear particles obtained during wear tests in task 3 will be analysed in terms of size, shape, composition and mass for the two of three tested solution. These data will be used to propose a first analysis of the toxicity of wear particles of new nickel alloys compared to current cobalt alloy.

Task 5: Selection for demonstrator

Based on the best results of each previous task the applicants will realize 4 sealing rings for assembly in a bleed valve demonstrator that will be submitted to an endurance test. The Topic Manager will provide all parts of the valve (except for the sealing rings), will assemble the complete valve and will perform the valve endurance test. The Topic Manager will be in charge of the endurance test. After the test, the worn sealing rings will be analysed by the applicants. The success of this endurance test will ensure a TRL5 for the Topic Manager.

3. Major Deliverables/ Milestones and schedule (estimate)

*Type: R=Report, D=Data, HW=Hardware

Deliverables			
Ref. No.	Title - Description	Type*	Due Date
D1	Sealing rings specification and detailed state of the art on the best adapted nickel self-fluxing alloys	R	T0+3
D2.1	Centrifugal casting study synthesis	R	T0+18
D2.2	Direct Metal Deposition by laser cladding study synthesis	R	T0+18
D3	Samples tests report : hot hardness, tribo tests and wear analysis	R	T0+20
D4.1	Comparative Life Cycle Analysis of Self-Fluxing nickel alloys obtained by centrifugal casting and by Direct Metal Deposition	R	T0+24
D4.2	Preliminary analysis of wear particles toxicity	R	T0+24
D5	Report of sealing rings behaviour after valve endurance test	R	T0+24

Milestones (when appropriate)			
Ref. No.	Title - Description	Type*	Due Date
M1	Material selected and agreed with TM for process study	R	T0+3
M2	Samples for machining study, for metallographic and tribological tests	H	T0+14
M3	Process parameters available and selected based on wear resistance, on environmental and on health impacts	R	T0+20
M4	New sealing rings in nickel self-fluxing alloys available for bleed valve endurance test and characterized	H	T0+20
M5	Valve Endurance test realized by the Topic Manager	R	T0+22

4. Special skills, Capabilities, Certification expected from the Applicant(s)

Essential:

- Centrifugal casting capabilities
- Laser cladding or Direct Metal Deposition Skills and capabilities
- Metallurgical skills, with dedicated capabilities : SEM/EDX, thermogravimetric analysis, hot



hardness measurement capabilities

- Tribological test benches with high temperature tests capabilities, wear analysis skills
- Process life cycle analysis
- Toxicology analysis of wear particles skills and capabilities

Advantageous:

- Machining and grinding capabilities
- Eco design approach

5. **Abbreviations**

SEM/EDX	Scanning Electron Microscopy/Energy Dispersive X-ray
UHBR	Ultra High By pass Ratio
ECS	Environmental Control System

8. Clean Sky 2 – Technology Evaluator

I. JTI-CS2-2020-CfP11-TE2-01-12: Airport level assessments for fixed wing aircraft

Type of action (RIA/IA/CSA):		RIA	
Programme Area:		TE	
(CS2 JTP 2015) WP Ref.:		WP 4	
Indicative Funding Topic Value (in k€):		500	
Topic Leader:	DLR	Type of Agreement:	Implementation Agreement
Duration of the action (in Months):	30	Indicative Start Date (at the earliest)⁶⁴:	> Q4 2020

Topic Identification Code	Title
JTI-CS2-2020-CfP11-TE2-01-12	Airport level assessments for fixed wing aircraft
Short description	
This topic consists of performing airport level assessments. These comprise the simulation of airport air traffic applying operational fleet traffic procedures for a set of selected airports and the related quantification of noise & emissions benefits through Clean Sky 2 technology aircraft.	

Links to the Clean Sky 2 Programme High-level Objectives ⁶⁵				
This topic is located in the demonstration area:				
The outcome of the project will mainly contribute to the following conceptual aircraft/air transport type as presented in the scene setter:				
With expected impacts related to the Programme high-level objectives:				
Reducing CO₂ emissions	Reducing NO_x emissions	Reducing Noise emissions	Improving EU Competitiveness	Improving Mobility
<input checked="" type="checkbox"/>	<input checked="" type="checkbox"/>	<input checked="" type="checkbox"/>	<input type="checkbox"/>	<input type="checkbox"/>

⁶⁴ The start date corresponds to actual start date with all legal documents in place.

⁶⁵ For further info see Chapter 1 “Introduction to the Programme Scene Setter / Objectives” with key technology themes / demonstration areas. Detailed information available in the CS2 Development Plan accessible via the Clean Sky JU Website and EC Participant Portal.



1. Background

Cross-positioned within the Clean Sky 2 Programme, the Technology Evaluator (TE) is a dedicated evaluation platform. It has the key role of assessing the environmental impact of the technologies developed in Clean Sky 2 and their level of success towards well-defined environmental (noise, CO₂, NO_x) and societal benefits and targets.

These technologies are developed by the IADPs (Innovative Aircraft Demonstrator Platforms) and ITDs (Integrated Technology Demonstrator projects) and clustered in coherent and mutually compatible solution sets, defining concept aircrafts. TE will conduct assessments on the various concept aircrafts at three levels:

- Aircraft level
A Clean Sky 2 concept aircraft and its reference technology aircraft⁶⁶ is compared along the same trajectory in order to determine the environmental benefit of the Clean Sky 2 technologies, namely noise on ground and emissions (CO₂ and NO_x).
- Airport level
A Clean Sky 2 concept aircraft replaces its reference technology counterpart at different time scales up to 2050 for selected airport traffic scenarios. The purpose of this replacement approach is to evaluate the full potential of environmental benefits of Clean Sky 2 technologies to an airport area, namely noise on the ground and population impacted by certain noise levels and emissions (CO₂ and NO_x).
- Air transport system (ATS) level
Similarly to airport level, a Clean Sky 2 concept aircraft replaces its reference technology counterpart at different time scales up to 2050 for airport traffic scenarios. However, in this case the impact is measured at European level.

Within the perimeter of this call the Partner shall perform airport level assessments (TE Work package 4) for aircraft applications based on scenarios defined by the Topic Manager.

TE work packages:

WP0	TE Management
WP1	TE scope and setup
WP2	TE interfacing with IADP/ITDs and TAs
WP3	TE integration on Mission level
WP4	TE airport impact assessment
WP5	TE ATS impact assessment
WP6	TE Information System
WP7	TE Dissemination

2. Scope of work

The project will build and extend on a previous aircraft airport assessment project that has been performed for the 1st TE assessment. In this context updated Concept aircraft models with a more mature set of technologies will be provided by the Topic Manager, in agreement with the relevant Clean Sky 2 Members for:

⁶⁶ The reference technology aircraft is the current state-of-the-art in 2014.

- Long range aircraft and their reference
- Short and Medium Range aircraft and their reference
- Regional aircraft and their reference

The aim is to perform environmental (noise, emissions) impact assessments for different traffic and fleet mixes at airports showing the benefit of Clean Sky 2 technologies. Assessments will be carried out for the following airports: Amsterdam, Rome, Stockholm, Hamburg and Toulouse. The main milestone will be the contribution to the 2nd TE assessment in 2023. In extension to the CfP05 project additional metrics will be applied (e.g. noise energy, local air quality, third party risk). The project eventually quantifies airport related impacts based on new forecasts and scenarios.

The airport impact assessments comprise:

Environmental and other impact, including

- Noise on the ground and population impacted by certain noise levels. Metrics should comprise Lden/Lnight as well as metrics related to sleep disturbance and annoyance.
- Emissions (CO₂ and NO_x)
- A new type of environmental indicator (e.g. NAX⁶⁷ or a Noise energy based metric) will be included.
- Analysis and quantification of the impact of individual risk and of risk to groups of people on ground in the vicinity of the airport, i.e. analysis of current and future safety standards measured through the probability of fatal accidents.
- Contribution to local air quality

All airport level assessments are carried out in the frame of TE WP4 for aircraft traffic at and around airports (table1 and 2).

Airport level assessments address the air traffic movements from aircraft at and around airports, including local airspace (e.g., control zones and terminal manoeuvring areas). Within a given airport fleet the Clean Sky 2 concept aircrafts environmental impact is assessed covering a range of air traffic from regional, short/medium range and long range aircraft. After insertion of Clean Sky 2 concept aircrafts in a number of airport fleets according to flight schedules provided by the topic manager, the assessments will quantify the *Clean Sky 2* benefits in terms of environmental impacts (noise, emissions) but also including capacity and time efficiency where relevant.

In summary the work will cover:

- 1) modelling a set of airports (see below): these will include the same as for 1st CS2 TE assessment
- 2) simulation of airport aircraft traffic scenarios with adequate tools
- 3) quantification of Clean Sky 2 environmental benefits

Table 1 lists the tasks to be performed:

Tasks		
Ref. No.	Title - Description	Due Date
WP 4.1	Set of representative airports and traffic Scenarios <ul style="list-style-type: none"> ▪ The set of representative airports will be the same as for the 1st CS2 TE assessments and cover all airport types from regional to hubs. The airports 	T0+15

⁶⁷ Number of noise events above a certain noise level during a given time period.

Tasks		
Ref. No.	Title - Description	Due Date
	<p>to be assessed will be the following: Amsterdam, Rome, Stockholm, Hamburg and Toulouse.</p> <ul style="list-style-type: none"> ▪ A generic airport (CAEP-port) for local air quality assessment will be used. ▪ The topic manager will provide the partner with flight schedules for the selected airports. Based on flight schedules provided by the topic manager airport aircraft fast time traffic simulation for the selected airports in WP4.1 will be done: the simulations will use real flight procedures at these airports, i.e. movements are conflict free, in particular in the sense that (horizontal and vertical) separation requirements between aircraft are respected. 	
WP 4.3	<p>Airport assessments (aircraft traffic)</p> <ul style="list-style-type: none"> ▪ Based on the fast time traffic simulations quantification of noise and emission environmental benefits for the selected airports in WP4.1 will be done. ▪ Higher aggregated noise footprint calculations covering all major European airports (about 50) will be done making use of statistical runway usage data for these airports. 	T0+28

3. Major Deliverables/ Milestones and schedule (estimate)

*Type: R=Report, D=Data, HW=Hardware

Deliverables			
Ref. No.	Title – Description	Type*	Due Date
D1	Dissemination and Communication Plan	R	6
D2	Scenarios definition and FTS reports	R	15
D 3	<p>quantification of the Clean Sky 2 environmental benefits for:</p> <ul style="list-style-type: none"> ▪ Noise and emissions for the selected airports with fast time traffic simulation (see WP4.1) ▪ Noise covering all major European airports at higher aggregated level (see WP4.3) 	R	T0+24
D 4	dissemination/communication of results	R	T0+30

Milestones (when appropriate)			
Ref. No.	Title - Description	Type*	Due Date
M1	Finalisation of Fast Time Simulation		T0+14
M2	TE assessment	R	T0+24

4. Special skills, Capabilities, Certification expected from the Applicant(s)

Essential:

- Profound knowledge and expertise and experience in the application of Fast-Time simulation tools for airport air traffic optimization used in the context of Departure and Approach simulations as well as Airport Ground Movements studies



- Profound knowledge and expertise and experience in noise and emissions calculations in the wide vicinity of airports
- Profound knowledge in aircraft noise and emissions modelling, airport categorizations and operational scenario modelling for aircraft fleet applications at large (and complex) airports, including TMA operations
- Profound knowledge in simulation platforms to perform integrated airport impact assessments (e.g. trade-off studies and optimization) in an integrated way and at different levels of detail (e.g. ranging from key performance indicators to detailed impact results)
- Profound knowledge and expertise in aviation safety, and third party risk modelling and analysis
- Capable of building on both methodology and results from 1st CS2 TE assessment

Advantageous:

- Extensive expertise and experience in the definition of future airport aircraft traffic (development) scenarios
- Extensive expertise and experience in the application of airport noise modelling tools - compliant with the best practice modelling guidance provided by both ECAC Doc.29 4th Edition and ICAO Document 9911 – including the simulation of noise exposure to populations around given airports
- Extensive expertise and experience in the modelling and simulation of noise for assessing noise experience (including capability enabling the experience of noise of aircraft flyovers in virtual reality environment).

II. JTI-CS2-2020-CfP11-TE2-01-13: Airport and ATS Level Assessment for Rotorcraft

Type of action (RIA/IA/CSA):		RIA	
Programme Area:		TE	
(CS2 JTP 2015) WP Ref.:		WP 4	
Indicative Funding Topic Value (in k€):		500	
Topic Leader:	DLR	Type of Agreement:	Implementation Agreement
Duration of the action (in Months):	30	Indicative Start Date (at the earliest)⁶⁸:	> Q4 2020

Topic Identification Code	Title
JTI-CS2-2020-CfP11-TE2-01-13	Airport and ATS Level Assessment for Rotorcraft
Short description	
This topic consists of performing airport level assessments. These comprise the simulation of airport air traffic applying operational fleet traffic procedures for a set of selected airports and the related quantification of noise & emissions benefits through Clean Sky 2 technology aircraft.	

Links to the Clean Sky 2 Programme High-level Objectives ⁶⁹				
This topic is located in the demonstration area:				
The outcome of the project will mainly contribute to the following conceptual aircraft/air transport type as presented in the scene setter:				
With expected impacts related to the Programme high-level objectives:				
Reducing CO ₂ emissions	Reducing NO _x emissions	Reducing Noise emissions	Improving EU Competitiveness	Improving Mobility
<input checked="" type="checkbox"/>	<input checked="" type="checkbox"/>	<input checked="" type="checkbox"/>	<input type="checkbox"/>	<input checked="" type="checkbox"/>

⁶⁸ The start date corresponds to actual start date with all legal documents in place.

⁶⁹For further info see Chapter 1 “Introduction to the Programme Scene Setter / Objectives” with key technology themes / demonstration areas. Detailed information available in the CS2 Development Plan accessible via the Clean Sky JU Website and EC Participant Portal.



1. Background

Cross-positioned within the Clean Sky 2 Programme, the Technology Evaluator (TE) is a dedicated evaluation platform. It has the key role of assessing the environmental impact of the technologies developed in Clean Sky 2 and their level of success towards well-defined environmental (noise, CO₂, NO_x) and societal benefits and targets.

These technologies are developed by the IADPs (Innovative Aircraft Demonstrator Platforms) and ITDs (Integrated Technology Demonstrator projects) and clustered in coherent and mutually compatible solution sets, defining concept vehicles. In the context of this call TE will conduct assessments on Fast rotorcraft configurations at three levels:

- Rotorcraft level
A Clean Sky 2 concept rotorcraft and its reference technology aircraft⁷⁰ is compared along the same trajectory in order to determine the environmental benefit of the Clean Sky 2 technologies, namely noise on ground and emissions (CO₂ and NO_x).
- Heliport/city location level
A Clean Sky 2 concept rotorcraft replaces its reference technology counterpart at time scales up to 2050 for heliport/city location traffic scenarios. The purpose of this replacement approach is to evaluate the full potential of environmental benefits of Clean Sky 2 technologies at a heliport/city location, namely noise on the ground and population impacted by certain noise levels and emissions (CO₂ and NO_x).
- Air transport system (ATS) level
Similarly to heliport/city location level, a Clean Sky 2 concept rotorcraft replaces its reference technology counterpart at different time scales up to 2050 but then for rotorcraft traffic fleet scenarios at European and/or worldwide level.

Within the perimeter of this call the Partner shall perform heliport/city location (TE Work Package 4) and ATS (TE Work Package 5) assessments for Fast rotorcraft applications. Traffic scenarios will be discussed with the Topic Manager and the relevant Clean Sky 2 Members.

TE work packages:

WP0	TE Management
WP1	TE scope and setup
WP2	TE interfacing with IADP/ITDs and TAs
WP3	TE integration on Mission level
WP4	TE airport impact assessment
WP5	TE ATS impact assessment
WP6	TE Information System
WP7	TE Dissemination

2. Scope of work

The project will build and extend on the previous rotorcraft heliport and fleet assessment project that has been performed for the 1st TE assessment. In this context updated Concept rotorcraft models/data packs with a more mature set of technologies will be provided by the Topic Manager, in agreement with

⁷⁰ The reference technology aircraft is the current state-of-the-art in 2014.

the relevant Clean Sky 2 Members for fast rotorcraft configurations:

- Tiltrotor and its reference
- Compound helicopter and its reference

As the above Fast rotorcraft configurations have low pax capacities, the Partner will be required to carry out the following additional assessments:

- Modelling (existence of adequate tools assumed) of advanced fast compound configurations for higher passenger capacities (50 to 70 pax), longer range and higher speeds. Configurations may also include elements of hybrid electric concepts for propulsion.

Regarding the rotorcraft mission types, this includes the modelling of:

- Passenger transport
- Emergency and medical services (EMS)
- Search and rescue (S&R)
- Oil and gas (O&G)

The aim is to perform environmental (noise, emissions) impact assessments for different traffic and rotorcraft fleet mixes at heliports/city locations showing the benefit of Clean Sky 2 technologies. Mobility/Connectivity through the usage of faster helicopters will be assessed at fleet level (e.g. hub feeder scenarios, combination ground and rotorcraft transport for remote regions, passenger transport to oil platforms). Assessments will be carried out for heliport/city location traffic scenarios for the above mentioned types of missions. The main milestone will be the contribution to the 2nd TE assessment in 2023. In extension to the CfP 05 project the partner will additionally model an advanced high passenger fast compound configuration. Mobility/connectivity will be addressed at worldwide level and not only for Europe. The project eventually quantifies airport related impacts based on new forecasts and scenarios.

The heliport/city location impact assessments comprise:

Environmental impact, including:

- noise on the ground and population impacted by certain noise levels
- emissions (CO₂ and NO_x)

The Air Transport System (ATS) impact assessments comprise:

Environmental impact, including:

- noise on the ground and population impacted by certain noise levels
- emissions (CO₂ and NO_x)

Mobility impact, namely:

- connectivity (e.g. reduction in travel time)
- productivity improvements (e.g. reduction of man hours in flight)

All rotorcraft assessments are carried out in the frame of WP4 for rotorcraft traffic at heliport/city locations level and in the frame of WP5 for rotorcraft traffic in world regions (See table 1 and 2).

Table1 lists the tasks to be performed:

Table 1 lists the tasks to be performed:

Tasks		
Ref. No.	Title - Description	Due Date

Tasks		
Ref. No.	Title - Description	Due Date
WP 4.2	<p>Heliport/city location assessments</p> <ul style="list-style-type: none"> ■ The Partner will in discussion with the Topic Manager and the relevant Clean Sky 2 Members select relevant heliports/city locations and define traffic schedules to carry out environmental impact assessments for noise and emissions. ■ Rotorcraft mission types to be addressed will be: <ul style="list-style-type: none"> - Passenger transport - Emergency and medical services (EMS) - Search and rescue (S&R) - Oil and gas (O&G) <p>Included will be the modelling of advanced Fast compound configurations for higher passenger capacities (50 to 70 pax), longer range and higher speeds. Configurations may also include elements of hybrid electric concepts for propulsion.</p>	T0+12
WP 5.3	<p>ATS assessments</p> <ul style="list-style-type: none"> ■ The Partner will in discussion with the Topic Manager and the relevant Clean Sky 2 Members use specified use cases for fleet traffic scenarios and flight schedules for selected world regions and carry out environmental and mobility/connectivity/productivity impact assessments ■ Rotorcraft mission types to be addressed will be: <ul style="list-style-type: none"> - Passenger transport - Oil and gas (O&G) - Emergency and medical services (EMS) - Search and rescue (S&R) <p>Included will be the modelling of advanced Fast compound configurations for higher passenger capacities (50 to 70 pax), longer range and higher speeds. Configurations may also include elements of hybrid electric concepts for propulsion.</p>	T0+24

3. Major Deliverables/ Milestones and schedule (estimate)

*Type: R=Report, D=Data, HW=Hardware

Deliverables			
Ref. No.	Title – Description	Type*	Due Date
D1	Communication dissemination & Exploitation plan	R	T0+6
D 2	Generation of fast rotorcraft traffic scenarios for heliport/city location level for all mission types (see above WP4.2) and related noise & emission assessments.	R	T0+12
D3	Development of a 50-70 pax capacity fast compound rotorcraft architecture that can be ‘virtually’ flown on multiple, realistic, 4D mission scenarios.	R	T0+15

Deliverables			
Ref. No.	Title – Description	Type*	Due Date
D4	Generation of traffic scenarios for heliport/city location level for all mission types for the larger capacity compound rotorcraft (see above WP4.2) and related noise & emission assessments.	R	T0+20
D 5	Generation of fast rotorcraft traffic scenarios (includes larger capacity compound rotorcraft) at ATS level and related noise, emissions and	R	T0+28

Milestones (when appropriate)			
Ref. No.	Title - Description	Type*	Due Date
M1	Large Compound helicopter model completed	R	T0+15
M2	TE assessment	R	T0+28

4. Special skills, Capabilities, Certification expected from the Applicant(s)

Essential:

- Demonstrated expertise in the development and application of rotorcraft modelling and performance simulation tools.
- Demonstrated expertise in the development of comprehensive, highly integrated, multi-disciplinary simulation frameworks for rotorcraft assessment which should include among others; non-linear structural dynamics, 3D rotor dynamics, unsteady non-linear wake and blade aerodynamics, aeroelasticity, flight dynamics (trim, stability and control), real time flight simulation, power plant performance, gaseous emissions, models for noise generation and propagation to the ground, 4D trajectory analysis, rotorcraft sub-systems.
- Demonstrated expertise in the development of hybrid-electric and turbo-electric propulsion concepts.
- Demonstrated expertise in the modelling of different rotorcraft architectures e.g. conventional helicopters, tilt-rotors, compound with propellers/ducted fans, co-axial, co-axial/pusher configurations.
- Capable of building on both methodology and results from 1st CS2 TE assessment

Advantageous:

- Profound knowledge in operational scenario modelling for rotorcraft fleet applications at airport level and world regions for all mission types.
- Established track record including: expert team, international research caliber, working with industry and previous participation in large EU programmes, ability to manage large work packages at EU level.

III. **JTI-CS2-2020-CfP11-TE2-01-14: Reduction of the environmental impact of aviation via optimisation of aircraft size/range and flight network**

Type of action (RIA/IA/CSA):		RIA	
Programme Area:		TE	
(CS2 JTP 2015) WP Ref.:		WP 4	
Indicative Funding Topic Value (in k€):		500	
Topic Leader:	DLR	Type of Agreement:	Implementation Agreement
Duration of the action (in Months):	30	Indicative Start Date (at the earliest)⁷¹:	> Q4 2020

Topic Identification Code	Title
JTI-CS2-2020-CfP11-TE2-01-14	Reduction of the environmental impact of aviation via optimisation of aircraft size/range and flight network
Short description	
The study should investigate – based on a historical data from 2000 and 2014 plus demand forecast for the time until 2050 - emission and noise reduction potentials of an optimised combination of aircraft size/range and flight network – and identify potential impacts on stakeholders plus demand.	

Links to the Clean Sky 2 Programme High-level Objectives⁷²				
This topic is located in the demonstration area:				
The outcome of the project will mainly contribute to the following conceptual aircraft/air transport type as presented in the scene setter:				
With expected impacts related to the Programme high-level objectives:				
Reducing CO₂ emissions	Reducing NO_x emissions	Reducing Noise emissions	Improving EU Competitiveness	Improving Mobility
<input checked="" type="checkbox"/>	<input checked="" type="checkbox"/>	<input checked="" type="checkbox"/>	<input type="checkbox"/>	<input type="checkbox"/>

⁷¹ The start date corresponds to actual start date with all legal documents in place.

⁷² For further info see Chapter 1 “Introduction to the Programme Scene Setter / Objectives” with key technology themes / demonstration areas. Detailed information available in the CS2 Development Plan accessible via the Clean Sky JU Website and EC Participant Portal.

1. Background

Cross-positioned within the Clean Sky 2 Programme, the Technology Evaluator (TE) is a dedicated evaluation platform. It has the key role of assessing the environmental impact of the technologies developed in Clean Sky 2 and their level of success towards well-defined environmental (noise, CO₂, NO_x) and societal benefits and targets.

These technologies are developed by the IADPs (Innovative Aircraft Demonstrator Platforms) and ITDs (Integrated Technology Demonstrator projects) and clustered in coherent and mutually compatible solution sets, defining concept aircrafts. TE will conduct assessments on the various concept aircrafts at three levels:

- **Aircraft level**
A Clean Sky 2 concept aircraft and its reference technology aircraft⁷³ is compared along the same trajectory in order to determine the environmental benefit of the Clean Sky 2 technologies, namely noise on ground and emissions (CO₂ and NO_x).
- **Airport level**
A Clean Sky 2 concept aircraft replaces its reference technology counterpart at different time scales up to 2050 for selected airport traffic scenarios. The purpose of this replacement approach is to evaluate the full potential of environmental benefits of Clean Sky 2 technologies to an airport area, namely noise on the ground and population impacted by certain noise levels and emissions (CO₂ and NO_x).
- **Air transport system (ATS) level**
Similarly to airport level, a Clean Sky 2 concept aircraft replaces its reference technology counterpart at different time scales up to 2050 for airport traffic scenarios. However, in this case the noise impact is measured at European level.

Airlines offer long haul trips up to 15000 km and high frequencies of flights with aircraft designed for much longer ranges to improve customer choice and increase market shares – on cost of additional flights, capacity constraints at airports and increased noise and emissions. This triggers questions as to what extend range optimised aircraft and fuel optimised flight legs could reduce the CO₂ emissions. Forecast results show, that a shift to bigger aircraft on short and medium haul trips would be (technically) required to satisfy demand and at the same time address airport capacity constraints. To identify the potential emission reductions of an optimised combination of aircraft size/range and flight network compared to the current airline driven development is very important to Clean Sky, as the project results will on one hand highlight areas of improvement regarding noise/emissions; it will also provide knowledge to identify which emission/noise optimised aircraft types are required.

The project shall in a first analysis identify theoretical potentials for reducing CO₂ emissions within a network with range optimised aircraft (ensuring that demand can be satisfied) by comparing global flights from 2000 plus 2014 and flights with range & seat optimised aircrafts plus with frequency reductions and network optimisations. Those comparisons – under the condition that current and future demand can be satisfied while market acceptance and travel time is totally and partially ignored – shall consider three different levels of services:

- by splitting long haul flights into shorter legs including range / seat optimised aircraft; increased travel times shall be quantified as well;
- by reducing frequencies to the necessary minimum via use of bigger range / seat optimised

⁷³ The reference technology aircraft is the current state-of-the-art in 2014.

aircraft; demand decreases shall be quantified as well;

- both levels of services described above shall be investigated together; increased travel times and demand decreases shall be quantified as well.

This task shall also describe for the three combinations of network and fleet.

In a second step, the project shall describe potential impacts on stakeholders (passengers, manufacturers, airlines and airports plus people living in the near surrounding of airports). Proposals with sound approaches to quantify such impacts will be preferred.

In a third step, potential measures required to establish such an optimised global air transport system shall be identified in a qualitative way.

TE work packages:

WP0	TE Management
WP1	TE scope and setup
WP2	TE interfacing with IADP/ITDs and TAs
WP3	TE integration on Mission level
WP4	TE airport impact assessment
WP5	TE ATS impact assessment
WP6	TE Information System
WP7	TE Dissemination

2. Scope of work

In this project, the partner is expected to own aviation mainliner fleet and movements data for 2000 and 2014 stemming from the Official Airline Guide (OAG). The Partner will be provided by the Topic Manager, in agreement with the relevant Clean Sky 2 Members, with

- an aviation mainliner forecast (covering demand, fleet and movements on a global level) for the time until 2050.
- historical data and assumptions for future aircraft wrt. their performance on:
 - Long range aircraft and their reference
 - Short and Medium Range aircraft and their reference
 - Regional aircraft and their reference

All project activities are carried out in the frame of WP5 for ATS level assessments. Applicants should explain in the proposal methodology, models and metrics to perform the results (see task description below).

Table 1 lists the tasks to be performed:

Tasks		
Ref. No.	Title - Description	Due Date
WP 5.2	Agreement on detailed methodology, data, models/tools plus metrics with the topic manager	T0+3
WP 5.2	<p>Identification of theoretical potentials for reducing CO2 emissions via optimised aircraft, network and frequency reductions</p> <p>This task requires:</p> <ul style="list-style-type: none"> ▪ Analysis of historical global flights of 2000 and 2014 regarding the aircraft / fleet used and their related fuel consumption 	T0+12

Tasks		
Ref. No.	Title - Description	Due Date
	<ul style="list-style-type: none"> ▪ Analysis of future global flights up to 2050 regarding the aircraft / fleet used and their related fuel consumption ▪ Creation of three different alternatives (with a different aircraft fleet and a different network incl. reduced frequencies and reduced long haul flights) under the condition that current and future demand can be satisfied while market acceptance and travel time is totally and partially ignored; the alternatives shall consider three different levels of services: <ul style="list-style-type: none"> ○ by splitting long haul flights into shorter legs including range / seat optimised aircraft; increased travel times shall be quantified as well; ○ by reducing frequencies to the necessary minimum (to fit demand) via use of bigger range / seat optimised aircraft; potential demand decreases (caused by different departure /arrival times) and changes regarding aircraft fleet (on seat class level) shall be quantified as well; ○ both levels of services described above shall be investigated together in combination; increased travel times and demand decreases (caused by different departure /arrival times) and changes regarding aircraft fleet (on seat class level) shall be quantified as well. ▪ Comparison between alternatives and base cases (2000, 2014, forecast up to 2050) regarding fuel consumption and CO2 emissions. ▪ The topic manager will provide the partner with an aviation mainliner forecast (covering demand, fleet and movements on a global level for aircraft above 20 seats) for the time until 2050. 	
WP 5.2	<p>Assessment of potential impacts on stakeholders</p> <p>This task requires analysis of potential impacts on stakeholders such as:</p> <ul style="list-style-type: none"> ▪ passengers (travel time, ticket prices), ▪ manufacturers (fleet and production requirements), ▪ airlines (business models, network efficiency, profitability, market concentration), ▪ airports (capacity, profitability) ▪ people living in the near surrounding of airports (increase or decrease of movements, noise) <p>Proposals with sound approaches (to be described in the proposal) to quantify such impacts will be preferred.</p>	T0+21
WP 5.2	<p>Analysis of potential measures</p> <p>In a third step, potential measures required to establish such an optimised global air transport system shall be identified and briefly described.</p>	T0+24

3. Major Deliverables/ Milestones and schedule (estimate)

*Type: R=Report, D=Data, HW=Hardware

Deliverables			
Ref. No.	Title – Description	Type*	Due Date
D 1	Report on methodology, data, models/tools plus metrics agreed with the topic manager	R	T0+3
D 2	Report on theoretical potentials for reducing CO2 emissions via optimised aircraft, network and frequency reductions	R	T0+12
D 3	Report on potential impacts on stakeholders	R	T0+21
D 4	Report on potential measures	R	T0+24
D 5	Final report and dissemination/communication of results	R	T0+24

Milestones (when appropriate)			
Ref. No.	Title - Description	Type*	Due Date
M1	Final report and dissemination/communication of results	R	T0+24

4. Special skills, Capabilities, Certification expected from the Applicant(s)

Essential:

- Profound knowledge, expertise and experience in the application of tools for simulating traffic networks and their optimization
- Profound knowledge, expertise and experience in aircraft emissions calculations and modelling
- Profound knowledge, expertise and experience in aviation demand modelling and travel time analysis

Advantageous:

- Profound knowledge, expertise and experience in aviation network changes and related impact assessments regarding several or all fields listed below:
 - ticket prices
 - manufacturers production requirements
 - airlines business models, profitability, market concentration
 - airport capacity and profitability
 - aircraft and airport related noise calculations and modelling
- Established track record including: Expert team, International research caliber, working with industry and previous participation in large EU Programs

PART B: Thematic Topics

1. Overview of Thematic Topics

List of Topics for Calls for Proposals (CFP11) – Part B

Identification Code	Title	Type of Action	Value (Funding in M€)
JTI-CS2-2020-CFP11-THT-11	High power density/multifunctional electrical energy storage solutions for aeronautic applications	RIA	1.20
JTI-CS2-2020-CFP11-THT-12	Advanced High Power Electrical Systems for High Altitude Operation	RIA	1.00
JTI-CS2-2020-CFP11-THT-13	Sustainability of Hybrid-Electric Aircraft System Architectures	RIA	1.60
JTI-CS2-2020-CFP11-THT-14	Scalability and limitations of Hybrid Electric concepts up to large commercial aircraft	RIA	0.80

2. Call Rules

Before submitting any proposals to the topics proposed in the Clean Sky 2 Call for Proposals, all applicants shall refer to the applicable rules as presented in the “*Bi-Annual Work Plan 2020-2021*”⁷⁴ and the “*Rules for submission, evaluation, selection, award and review procedures of Calls for Proposals*”⁷⁵.

IMPORTANT:

The “additional conditions” laid down in the CS2JU Work Plan (see chapter 3.3 “*Call management rules*”) are not applicable to the topics listed in Part B of this Annex .

Special conditions apply to these topics which are launched outside the complementary framework of an IADP/ITD/TA (hereinafter referred to as Thematic Topics):

- **Page limit:**

The limit for a full proposal answering a Thematic Topic is **30 pages** in total, see proposal template B.I.

- **Scoring and weighting:**

For Thematic Topics: to determine the ranking, the score for the criterion ‘excellence’ will be given a weight of 1.5.

- **Number of winning proposals**

Under the Thematic Topics, more than one proposal per topic may be funded.

- **Admissibility**

Standard admissibility conditions and related requirements as laid down in Part B of the General

⁷⁴Doc. ref. CS-GB-2019-11-21 Bi-Annual WP and Budget 2020-2021, to be made available on the Participant Portal and the Clean Sky website

⁷⁵ Doc. ref. Written Proc. 2014 -11 CS2 Rules for submission CfP, available on the Participant Portal and the Clean Sky website

Annexes of the Work Programme 2020-2021 shall apply mutatis mutandis with the following additional condition(s) introduced below:

- The 16 Leaders of JU listed in Annex II to Regulation n° (EU) No 558/2014 and their affiliates⁷⁶ **may not apply** to the topics listed in Part B of this Annex .

Please note that proposals may include the commitment from the European Aviation Safety Agency (EASA) to assist or to participate in the action without EASA being eligible for funding.

3. Programme Scene setter/Objectives

In accordance with Article 2 of the COUNCIL REGULATION (EU) No 558/2014 of 6 May 2014⁷⁷ the **Clean Sky 2 high-level (environmental) objectives are:**

“(b) to contribute to improving the environmental impact of aeronautical technologies, including those relating to small aviation, as well as to developing a strong and globally competitive aeronautical industry and supply chain in Europe.

This can be realised through speeding up the development of cleaner air transport technologies for earliest possible deployment, and in particular the integration, demonstration and validation of technologies capable of:

(i) increasing aircraft fuel efficiency, thus reducing CO₂ emissions by 20 to 30 % compared to ‘state-of-the-art’ aircraft entering into service as from 2014;

(ii) reducing aircraft NO_x and noise emissions by 20 to 30 % compared to ‘state-of-the-art’ aircraft entering into service as from 2014.”

These Programme's high-level (environmental) objectives have been translated into **targeted vehicle performance levels**, see table below. Each conceptual aircraft summarises the key enabling technologies, including engines, developed in Clean Sky 2.

Conceptual aircraft / air transport type	Reference a/c*	Window ¹	ΔCO ₂	ΔNO _x	Δ Noise	Target ² TRL @ CS2 close
Advanced Long-range (LR)	LR 2014 ref	2030	20%	20%	20%	4
Ultra advanced LR	LR 2014 ref	2035+	30%	30%	30%	3
Advanced Short/Medium-range (SMR)	SMR 2014 ref	2030	20%	20%	20%	5
Ultra-advanced SMR	SMR 2014 ref	2035+	30%	30%	30%	4
Innovative Turboprop [TP], 130 pax	2014 130 pax ref	2035+	19 to 25%	19 to 25%	20 to 30%	4
Advanced TP, 90 pax	2014 TP ref ⁴	2025+	35 to 40%	> 50%	60 to 70%	5
Regional Multimission TP, 70 pax	2014 Multi-mission	2025+	20 to 30%	20 to 30%	20 to 30%	6
19-pax Commuter	2014 19 pax a/c	2025	20%	20%	20%	4-5
Low Sweep Business Jet	2014 SoA Business a/c	2035	> 30%	> 30%	> 30%	≥ 4
Compound helicopter ³	TEM 2020 ref (CS1)	2030	20%	20%	20%	6
Next-Generation Tiltrotor	AW139	2025	50%	14%	30%	5

*The reference aircraft will be further specified and confirmed through the Technology Evaluator assessment work.

1 All key enabling technologies at TRL 6 with a potential entry into service five years later.

2 Key enabling technologies at major system level. The target TRL indicates the level of maturity and the level of challenge

⁷⁶ See the definition under Article 2.1 (2) of the H2020 Rules for Participation

⁷⁷ OJ L 169, 7.6.2014, p.77

in maturing towards potential uptake into marketable innovations.

3 Assessment v. comparable passenger journey, not a/c mission.

4 ATR 72 airplane, latest SOA Regional A/C in-service in 2014 (technological standard of years 2000), scaled to 90 Pax.

To integrate, demonstrate and validate the most promising technologies capable of contributing to the CS2 high-level and programme specific objectives, the CS2 technology and demonstration activity is structured in **key (technology) themes**, further subdivided in a number of **demonstration areas**, as depicted below. A demonstration area may contribute to one or more objectives and also may involve more than one ITD/IADP.

Ref-Code	Theme	Demonstration area
1A	Breakthroughs in Propulsion Efficiency (incl. Propulsion-Airframe Integration)	Advanced Engine/Airframe Architectures
1B		Ultra-high Bypass and High Propulsive Efficiency Geared Turbofans
1C		Hybrid Electric Propulsion
1D		Boundary Layer Ingestion
1E		Small Aircraft, Regional and Business Aviation Turboprop
2A	Advances in Wings, Aerodynamics and Flight Dynamics	Advanced Laminar Flow Technologies
2B		Regional Aircraft Wing Optimization
3A	Innovative Structural / Functional Design - and Production System	Advanced Manufacturing
3B		Cabin & Fuselage
3C		Innovative Solutions for Business Jets
4A	Next Generation Cockpit Systems and Aircraft Operations	Cockpit & Avionics
4B		Advanced MRO
5A	Novel Aircraft Configurations and Capabilities	Next-Generation Civil Tiltrotor
5B		RACER Compound Helicopter
6A	Aircraft Non-Propulsive Energy and Control Systems	Electrical Systems
6B		Landing Systems
6C		Non-Propulsive Energy Optimization for Large Aircraft
7A	Optimal Cabin and Passenger Environment	Environmental Control System
7B		Innovative Cabin Passenger/Payload Systems
8A	Eco-Design	
9A	Enabling Technologies	
	Technology Evaluator	

The individual topic descriptions provide more detailed information about the link/contribution to the high-level objectives.

4. Clean Sky 2 – Thematic Topics

I. JTI-CS2-2020-CFP11-THT-11: High power density/multifunctional electrical energy storage solutions for aeronautic applications

Type of action (RIA/IA/CSA):		RIA	
Programme Area:		N/A	
(CS2 JTP 2015) WP Ref.:		N/A	
Indicative Funding Topic Value (in k€):		1200	
Topic Leader:	N/A	Type of Agreement:	N/A
Duration of the action (in Months):	30*	Indicative Start Date (at the earliest)⁷⁸:	> Q4 2020

*The JU considers that proposals requesting a contribution of 1200k€ over a period of 30 months would allow this specific challenge to be addressed appropriately. Nonetheless, this does not preclude submission and selection of proposals requesting other amounts and/or proposing different activity durations.

Topic Identification Code	Title
JTI-CS2-2020-CFP11-THT-11	High power density/multifunctional electrical energy storage solutions for aeronautic applications
Short description	
Clean alternatives are demanded for aviation, and combustion engines will be progressively combined or even substituted by electrical motors. This is one of the several reasons that make more electric aircraft and all electric aircraft the clear trend for aerospace. These concepts imply a considerable increase of electrical power demand on board, and in order to satisfy it with no use of fuel, the improvement in electrical energy storage need to be addressed. This project will address solutions to increase the power density of batteries (i.e. by investigating new battery chemistries) and solutions for better integration at aircraft level (i.e. by integrating the batteries in the aircraft structure, with the aim of rise the overall power density performance of the storage system saving weight and volume).	

Links to the Clean Sky 2 Programme High-level Objectives ⁷⁹				
This topic is located in the demonstration area:				NA
The outcome of the project will mainly contribute to the following conceptual aircraft/air transport type as presented in the scene setter:				NA
With expected impacts related to the Programme high-level objectives:				
Reducing CO ₂ emissions	Reducing NO _x emissions	Reducing Noise emissions	Improving EU Competitiveness	Improving Mobility
<input checked="" type="checkbox"/>	<input checked="" type="checkbox"/>	<input checked="" type="checkbox"/>	<input checked="" type="checkbox"/>	<input checked="" type="checkbox"/>

⁷⁸ The start date corresponds to actual start date with all legal documents in place.

⁷⁹For further info see Chapter 1 “Introduction to the Programme Scene Setter / Objectives” with key technology themes / demonstration areas. Detailed information available in the CS2 Development Plan accessible via the Clean Sky JU Website and EC Participant Portal.

1. Specific challenge

The More Electric Aircraft (MEA) concept is already ruling the aircraft design and the all electric aircraft (AEA) concept is rising up. New mobility solutions and MEA are linked with the increase of electrical loads and power demand, and one of the main features regarding electric design of both of them is the energy storage.

Batteries are typically needed to keep the onboard systems working during start-up and emergency conditions, but with the incorporation of electrical engines, the role of the batteries becomes even more critical. Electrical engines provide clean propulsion to the aircraft, being the key factor for the future of green aviation. Energy for combustion engines is stored in fuel, and energy for electrical engines is stored in batteries. Nowadays, the power density of fuel is still by far superior to batteries, therefore batteries require higher volume and size to deliver the same amount of energy. If the all electric aviation advent is expected to be successful, improvements in the capacity of the aircraft energy storage are required.

Recent AIRBUS prototypes show the all electric aircraft concept is feasible, like the E-Fan, that has completed flights during more than 20 minutes, with two electrical engines powered by batteries.



Figure 1. E-Fan in flight

As a solution to increase the amount of energy stored with low weight impact, studies to increase the power density of battery cells as such and/or the integration of the batteries with the aircraft structure is proposed. The proposers have the freedom to address one or both of these objectives.

2. Scope

The main challenge for battery technology is to reach higher energy density levels. Proposers are expected to provide solutions to increase the energy storage density of current battery systems (lithium-ion, lithium-sulphur and lithium-air, etc.) battery technology. Thereby also the influence of the developments on the provided power densities shall be addressed. Furthermore the used electrolyte shall be considered including the option for all solid state batteries at least of the lithium-ion and lithium-air types. The aspects of evolution of charge and discharge efficiency shall be addressed, which

can be used to estimate the required cooling of the system in flight and during recharge whilst grounded. Thermal management as well as fire protection aspects should be considered.

The thermal management, and thermal behaviour, such as resulting from short-circuit inside the batteries, thermal runaway or fire in the aircraft are to be studied. Thermal management systems should be devised. Fire retardant action should be considered. Need of thermal protection insulation is to be studied and solutions proposed.

Finally aspects regarding the battery production technology shall be addressed. For all developments, production technology developments and material usage should be included. Besides the analysis of expected costs and capacity it is also of high interest to analyse the expected quality evolution and cell failure rates as a flight battery will comprise extremely high number of cells requiring new levels of quality assurance.

Whereas the typical batteries are a joint sets of elements (cells, control electronics, cover, etc.), some of these elements offer structural properties that could be used for carrying out the physical support of other elements onboard, i.e. to carry out structural functions. On the other hand, the new composite materials of the structure allow to integrate electrical storage properties with some modifications. Then multifunctional structures could be developed which are able to perform structural and electrical functions, with the aim to increase the energy storage power density of the aircraft. It may consist of an innovative concept for a multifunctional structural battery based on lithium-ion (or other) battery materials as load bearing elements in a sandwich panel construction or other form.

Some structural battery prototypes have recently demonstrated an initial capacity of 3,7 Ah, a volumetric energy density of 248 Wh/L, a specific energy higher than of 400 Wh/kg, and a capacity retention of 90% after 300 charge–discharge cycles at $\sim C/10$ rate and eight mechanical loading cycles.

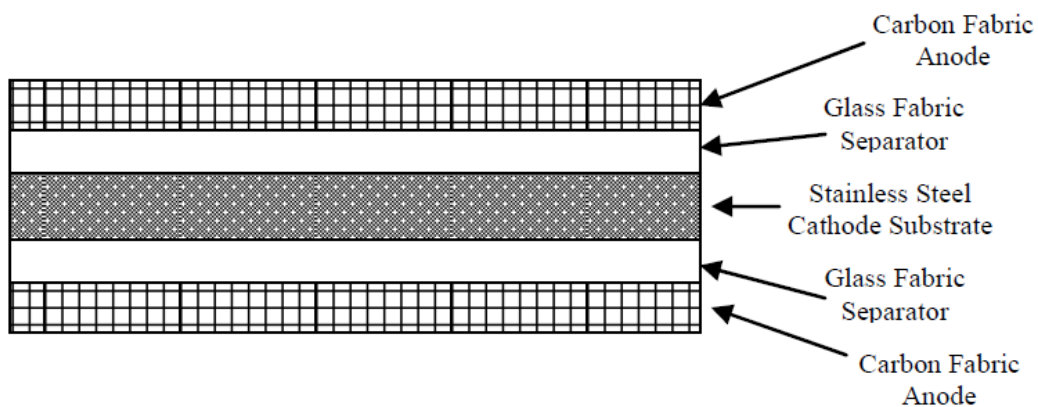

Figure 2. Example of multifunctional material scheme.

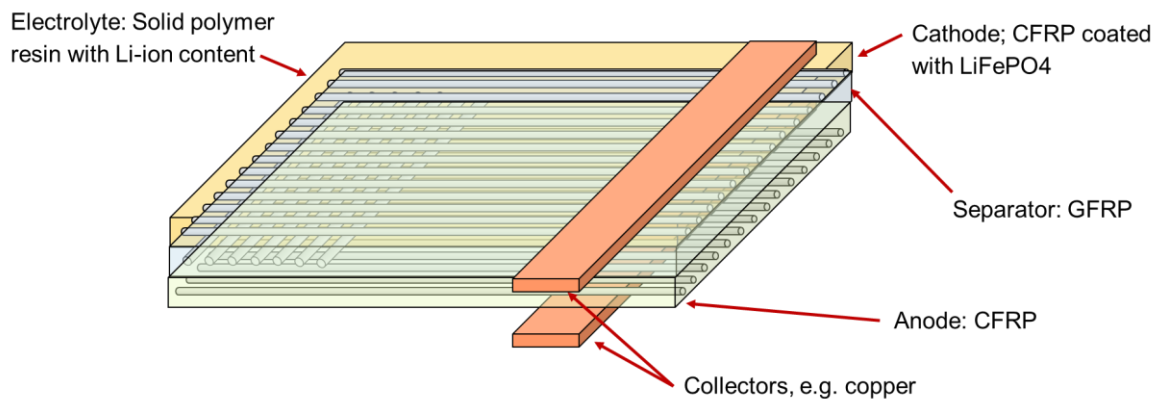

Fig. 3. Multi functional material battery, here a composite battery consisting of anode (CFRP), Separator (GFRP), cathode (CFRP + LiFePO4 coating), copper current collectors.

The mechanical stiffness in three-point bend tests follows expectations based on sandwich beam theory, proving that the battery materials are sharing in the load-carrying function of the sandwich panel. While areas for improvement of the fabrication and performance of these type of prototypes still exist, the results of the current investigation demonstrate the promising potential of the proposed structural battery concept for the efficient use of space and mass in an electric vehicle.

Integration of suitable cells should be studied and a demonstrator at a relevant scale should be built and tested. Upscaling of the size of the cells is to be performed. The attachment of the cells is to be studied, considering cell carriers, or mechanical attachment devices.

Accessibility, sensing and management will be addressed.

Cyclic behaviour and life span should be studied.

Both battery- and super capacitor function may be investigated.

Note : Energy harvesting devices are not considered in scope.

3. Expected outcomes/impact

Proposals may address one or both objectives described in the previous section or new solutions responding to the need of high power density/multifunctional electrical energy storage . Demonstration and experimental validation up to a lab-scale level are expected.

The expected outcome of the project should include:

- A literature survey establishing the State-Of-the-Art related to proposed solutions.
- Key technologies/concepts helping progress in the selected fields of application.
- Definition of the roadmap for implementation with identification of TRL gates
- Identification of technical challenges preventing the successful deployment of such technologies.
- Demonstration and experimental validation up to a lab-scale level at a representative geometrical scale for aircraft structures.

4. Topic special conditions

Special conditions apply to this topic:

- **Page limit:**

The limit for a full proposal answering a Thematic Topic is **30 pages** in total, see proposal template B.I.

- **Scoring and weighting:**

For Thematic Topics: to determine the ranking, the score for the criterion 'excellence' will be given a



weight of 1.5.

- **Number of winning proposals:**

Under the Thematic Topics, more than one proposal per topic may be funded.

- **Admissibility:**

Standard admissibility conditions and related requirements as laid down in Part B of the General Annex of the Work Programme shall apply mutatis mutandis with the following additional condition(s) introduced below:

- The 16 Leaders of JU listed in Annex II to Regulation n° (EU) No 558/2014 and their affiliates⁸⁰ **may not apply** to the topics listed in this call text document.

5. Abbreviation/acronyms

AEA All Electric Aircraft
MEA More Electric Aircraft
HVDC High Voltage and Direct Current

⁸⁰ See the definition under Article 2.1 (2) of the H2020 Rules for Participation

II. JTI-CS2-2020-CFP11-THT-12: Advanced High Power Electrical Systems for High Altitude Operation

Type of action (RIA/IA/CSA):		RIA	
Programme Area:		N/A	
(CS2 JTP 2015) WP Ref.:		N/A	
Indicative Funding Topic Value (in k€):		1000	
Topic Leader:	N/A	Type of Agreement:	N/A
Duration of the action (in Months):	30*	Indicative Start Date (at the earliest)⁸¹:	> Q4 2020

**The JU considers that proposals requesting a contribution of 1000k€ over a period of 30 months would allow this specific challenge to be addressed appropriately. Nonetheless, this does not preclude submission and selection of proposals requesting other amounts and/or proposing different activity durations.*

Topic Identification Code	Title
JTI-CS2-2020-CFP11-THT-12	Advanced High Power Electrical Systems for High Altitude Operation
Short description	
<p>The topic will address the issue of managing high voltage / high power electrical systems at high altitude. It is well known that the requirements in aeronautics are putting strong constraints on the system architecture in terms of reliability and safety. This topic is aiming at providing solutions for components of the electrical system which provide high power density performance while complying with the reliability and safety requirements. This covers components relevant for power electronics (converters, inverters, etc.), distribution, circuit breakers, motors and generators. This topic aims to support advances in any of those fields to enable operation at high altitude of suitable electrical system architectures for aeronautic applications. Arcing/arc tracking is one of the major issues to be solved within this context. Applicants may choose to address one or several of the aspects of the call. Demonstration and validation at lab scale level is experimentally expected.</p>	

Links to the Clean Sky 2 Programme High-level Objectives⁸²				
This topic is located in the demonstration area:				NA
The outcome of the project will mainly contribute to the following conceptual aircraft/air transport type as presented in the scene setter:				NA
With expected impacts related to the Programme high-level objectives:				
Reducing CO₂ emissions	Reducing NO_x emissions	Reducing Noise emissions	Improving EU Competitiveness	Improving Mobility
<input checked="" type="checkbox"/>	<input checked="" type="checkbox"/>	<input checked="" type="checkbox"/>	<input checked="" type="checkbox"/>	<input checked="" type="checkbox"/>

⁸¹ The start date corresponds to actual start date with all legal documents in place.

⁸² For further info see Chapter 1 "Introduction to the Programme Scene Setter / Objectives" with key technology themes / demonstration areas. Detailed information available in the CS2 Development Plan accessible via the Clean Sky JU Website and EC Participant Portal.

1. Specific challenge

This topic addresses the general issue of managing high voltage / high power electrical systems at high altitude.

This topic is aiming at providing solutions for components of the electrical system which provide high power density performance while complying with the reliability and safety requirements. This covers components relevant for power electronics (converters, inverters, etc.), distribution, circuit breakers, motors and generators. It is well known that the requirements in aeronautics are putting strong constraints on the system architecture in terms of reliability and safety. Arcing/arc tracking is one of the major issues to be solved within this context.

The more electric agenda may also lead in the future to a totally different thermal management system on-board, enabled by the use of cryo-fuels (LH2 or LNG) either for use with fuel cells or as a propellant for gas turbine driven propulsion components. This opens the way to cryo-cooled electronic components as well as superconducting devices. Recent developments in HTS (high temperature superconducting) devices have revealed very promising perspectives. The topic aims to support advances in any of those fields to enable operation at high altitude of suitable electrical system architectures for aeronautic applications.

An example of relevant architectures can be taken from the currently running E-Fan-X project, led by Airbus, Siemens and Rolls-Royce. The objective of replacing one of the four turbofan engines by a 2MW electric motor has shown to require an electrical distribution scheme at 3000 V DC inside the aircraft (Figure 1).

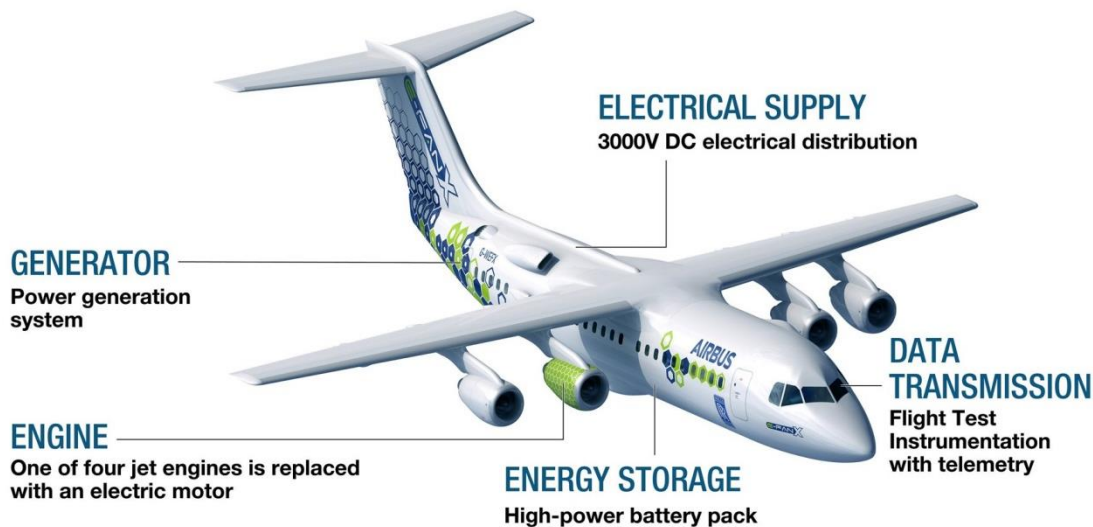

Figure 1. Main features of the E-Fan-X test aircraft.

In order to supply the electric motor, a gas turbine based turbogenerator is driving a 2MW generator, feeding a 2 MW battery pack through a power distribution center and a so-called HEPS (Hybrid Electric Propulsion System) E-Supervisor (Figure 2). The motor power electronics, the inverter, DC/DC converter, and power distribution system must be designed and dimensioned to reach satisfactory volumetric and mass energy densities.

The main interest of this ambitious project is however also to explore and better understand thermal effects, power management, altitude and dynamic effects (arcing, etc.), as well as electromagnetic issues of this 3,000 volt power system.

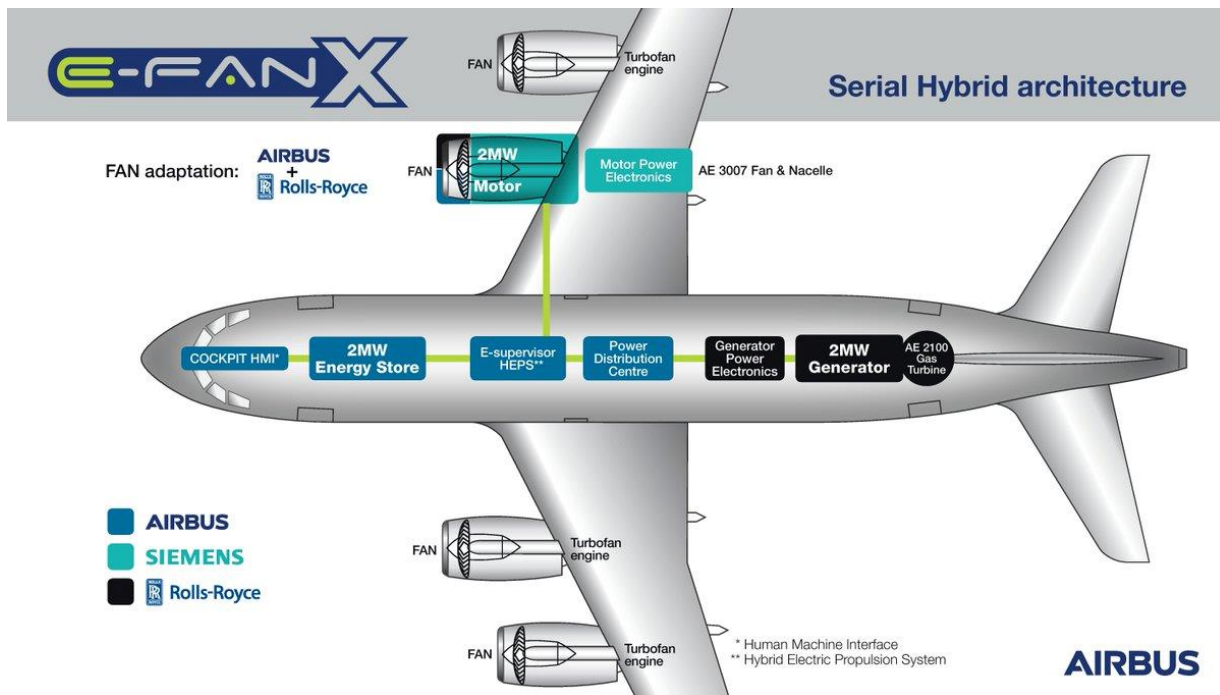

Figure 2. Main features of the E-Fan-X hybrid electric system layout.

2. Scope

The scope of this topic in terms of timeframe is twofold: progress on short-term technology developments for EIS 2025, and on breakthrough technologies for longer term developments for EIS 2035 and beyond.

Further developments of key technologies/tools helping progress in high voltage / high power electrical on-board systems technology are expected in the following areas:

- Progress in **fundamental understanding and modelling** of high power electrical systems, including (but not limited to) thermal effects, power management, altitude and dynamic effects (arcing, etc.), as well as electromagnetic issues.
- Progress in terms of **component technologies**:

- o Power Electronics

New WBG materials like SiC and GaN enable power electronic systems with already today relatively high power densities. Research activities in future materials like Aluminum nitride and Diamond together with new packaging solutions promise large potential in power electronics power density improvement. Relevant power electronic systems for future hybrid/electric aircraft may be defined, e.g. non-isolating unidirectional fuel cell DC/DC converters and bidirectional battery DC/DC converters, traction drive inverters for motors and generators, isolating DC/DC converters for low voltage supply and DC/AC grid inverters.

The study may evaluate technology potentials based on conventional technologies but research in cryo-cooled, superconducting topologies for future hybrid/electric aircraft (HTS, etc.) are strongly encouraged.

- o Electric Drives

Electric drives are available in a wide variety of topologies and technologies like synchronous and asynchronous machines or multiphase topologies. The study should evaluate technology potentials based on conventional technology electric drives but research in cryo-cooled, superconducting topologies for future hybrid/electric aircraft (HTS, etc.) are strongly

encouraged.

- Electric Power Distribution

Arc Fault Detection and Protection (AFDP) solutions are required to comply with safety requirements. Algorithm-based technologies can be used to detect arc faults according to its specific characteristics. This solution can be implemented through on board computers for detection and combined with electrical components like SSPC (Solid State Power Controllers) or AFCB (Arc Fault Circuit Breakers) for protection. Reflectometry techniques may be applied to manage the physical detection and neural networks (Artificial Intelligence) algorithms may be used to reduce the false trips.

Note: The power source in itself (battery, Fuel Cell or Turbine/ICE generator) are not considered as part of the scope of this topic, as they are covered by other specific actions.

3. Expected outcomes/impact

Proposals may address one or more component solutions/tools/concepts described in the previous section or new solutions responding to the need of high power electrical systems, at aircraft level. Demonstration and experimental validation up to a lab-scale level are expected.

The expected outcome of a project should include:

- A comprehensive literature review of the state-of-the-art in relation with the solution proposed.
- Key technologies/tools/concepts helping progress in high power electrical systems may cover one or several of the previously described items but the proposal should clearly state the initial TRL of the study and clear objectives in terms of (volumetric and mass) power density target.
- Identification of scientific and technical challenges preventing the successful deployment of such technologies.

4. Topic special conditions

Special conditions apply to this topic:

- **Page limit:**

The limit for a full proposal answering a Thematic Topic is **30 pages** in total, see proposal template B.I.

- **Scoring and weighting:**

For Thematic Topics: to determine the ranking, the score for the criterion 'excellence' will be given a weight of 1.5.

- **Number of winning proposals:**

Under the Thematic Topics, more than one proposal per topic may be funded.

- **Admissibility:**

Standard admissibility conditions and related requirements as laid down in Part B of the General Annex of the Work Programme shall apply mutatis mutandis with the following additional condition(s) introduced below:

- The 16 Leaders of JU listed in Annex II to Regulation n° (EU) No 558/2014 and their affiliates⁸³ **may not apply** to the topics listed in this call text document.

5. Abbreviations/Acronyms

AEA	All Electric Aircraft
AFCB	Arc Fault Circuit Breaker

⁸³ See the definition under Article 2.1 (2) of the H2020 Rules for Participation



AFDP	Arc Fault Detection and Protection
MEA	More Electric Aircraft
HVDC	High Voltage and Direct Current
SSPC	Solid State Power Controller
WBG	Wide Band Gap

III. JTI-CS2-2020-CFP11-THT-13: Sustainability of Hybrid-Electric Aircraft System Architectures

Type of action (RIA/IA/CSA):		RIA	
Programme Area:		N/A	
(CS2 JTP 2015) WP Ref.:		N/A	
Indicative Funding Topic Value (in k€):		1600	
Topic Leader:	N/A	Type of Agreement:	N/A
Duration of the action (in Months):	30*	Indicative Start Date (at the earliest)⁸⁴:	> Q4 2020

**The JU considers that proposals requesting a contribution of 1600k€ over a period of 30 months would allow this specific challenge to be addressed appropriately. Nonetheless, this does not preclude submission and selection of proposals requesting other amounts and/or proposing different activity durations.*

Topic Identification Code	Title
JTI-CS2-2020-CFP11-THT-13	Sustainability of Hybrid-Electric Aircraft System Architectures

Short description
Electric and hybrid-electric aircraft are expected to disruptively change aviation in the next decades. Potential benefits in terms of noise, emissions and flexibility drive a huge amount of ambitious R&D activities to overcome technological challenges on energy storage, supply and transmission. However, the full life cycle impact of future electric/hybrid aircraft technologies has not yet been addressed sufficiently. Sustainability of materials, processes and resources, efficiency of manufacture and production, lifetime services, as well as the end of life challenge need to be analyzed to evaluate competitive value and environmental impact of electric/hybrid aircraft from a full lifetime perspective. This topic intends provide particular Life Cycle Inventory Data for hybrid/electric aircraft technologies for the European aviation industry as reference related to future electric/hybrid aircraft according to eco-DESIGN Standards. A 50 pax regional class A/C shall be used as target application for harmonization of the system requirements and will set focal nodes on short- mid- and long-term developments for relevant system technologies.

Links to the Clean Sky 2 Programme High-level Objectives ⁸⁵				
This topic is located in the demonstration area:			NA	
The outcome of the project will mainly contribute to the following conceptual aircraft/air transport type as presented in the scene setter:			NA	
With expected impacts related to the Programme high-level objectives:				
Reducing CO ₂ emissions	Reducing NO _x emissions	Reducing Noise emissions	Improving EU Competitiveness	Improving Mobility
☒	☒	☒	☒	☒

⁸⁴ The start date corresponds to actual start date with all legal documents in place.

⁸⁵ For further info see Chapter 1 "Introduction to the Programme Scene Setter / Objectives" with key technology themes / demonstration areas. Detailed information available in the CS2 Development Plan accessible via the Clean Sky JU Website and EC Participant Portal.

1. Specific challenge

Electric and hybrid-electric aircraft are expected to disruptively change aviation in the next decades. Potential benefits in terms of noise, emissions and flexibility have been widely treated whereas, the full life cycle impact of future electric/hybrid aircraft technologies has not yet been addressed sufficiently. Sustainability of materials, processes and resources, efficiency of manufacture and production, lifetime services, as well as the end of life challenge need to be analyzed to evaluate competitive value and environmental impact of electric/hybrid aircraft from a full lifetime perspective.

This topic intends to provide particular Life Cycle Inventory Data for the European aviation industry to better support development and ambition toward future electric/hybrid aircraft according to ecoDESIGN Standards. A 50 pax regional class A/C shall be used as target application for harmonization of the system requirements and will set focal nodes on short- mid- and long-term developments for relevant system technologies.

Figure 1 shows a basic system layout with the key components for future hybrid/electric energy storage (Turbine/ICE generator; fuel cell; battery) and energy transmission (HV backbone, power electronics, electric propulsion), excluding ground energy supply. However, these systems rely on technology not available for service and today's short- and mid-term research activities basically focus on concepts for urban air mobility and short commuters up to 19 PAX. To realise a hybrid electric aircraft designed for 50 pax regional class, new technologies have to be developed and existing barriers have to be overcome for electrical energy storage, transmission and supply, to ensure mid- and long-term competitiveness of European aviation industry. At the same time the life cycle impact of these short, mid, and long term developments needs to be accounted for, in order to avoid developments which in total could not lead to a more sustainable aviation.

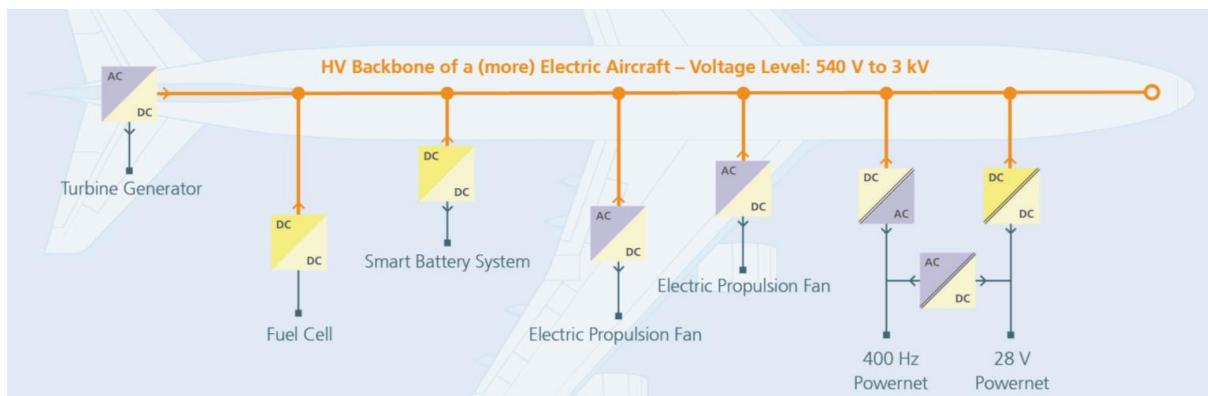

Figure 1: Exemplary energy transmission with distributed electrical systems in a hybrid/electric aircraft system.

Life Cycle Assessment and ecoDESIGN Analysis

Full Life Cycle Assessment is crucial for any trade-off evaluation on new technologies from both the economic and the ecological point of view; taking into account the circular economy, also aspects of re-use and recycling need to be included in a life cycle impact analysis.

2. Scope

The action will depart from an analysis and literature review of the State of the Art [SoA] of research and/or developments underway in the field of electric and hybrid/electric A/C architectures.

Previous and existing LCA studies (also from other sectors than the aeronautical one, i.e. automotive, rail, etc.) related to the main components of this type of architecture should be reviewed as well and presented.

As already mentioned, studies will be performed considering 50 pax regional class A/C . After defining the top level requirements depending on the mission (altitude, speed, range, etc), the consortium shall define a consistent energy transmission topology, based on battery and/or fuel cell and/or ICE/turbine generator technology. Several scenarios, or topologies should be considered in order to understand which are the most attractive solutions in terms of emission reduction, considering also the whole life cycle analysis of the system components. Comparison should be made with a typical reference aircraft, i.e. based on fossil fuel propulsion (kerosene), including the “well-to-tank” and “tank-to-wake” emissions production and life cycle impact.

Based on this top-down approach defining different potential topology scenarios, a bottom-up technology evaluation should be performed for storage, supply and transmission to determine technology performance targets to meet the requirements for a 50 pax regional class A/C, identifying existing technology barriers and possible solutions and approaches to overcome these. The consortium shall be able to adress the whole hybrid/electric drivetrain architecture (refer to exemplary Figure 1), including ground based energy supply, for the selected topology concept. Different horizons should be considered here in terms of technology available for a prototype, namely short- (EIS 2025+), mid- (EIS 2035+) and long term (EIS 2045+) technologies for each of the system components.

All identified materials, processes and resources of the system technologies, i.e. batteries, fuel cells (including H2 storage), gas turbine or ICE genset, power electronics, electric motors/generators, distribution and on ground energy supply, will give the input for Life Cycle Inventories (and conduct Life Cycle Analysis according to ecoDESIGN Standards). Validation shall be conducted for relevant Data on Life Cycle Inventory where appropriate.

3. Expected outcomes/impact

The expected project tasks and outcomes are listed and described in more detail below.

Tasks		
Ref. No.	Title – Description	Due Date
1	Basic Concepts, Requirement Analysis	M30
1.1	Overall Requirements for (hybrid) electric 50 pax regional A/C	M3
1.2	Scenarios & Requirements for Future Hybrid Electrical Propulsion and Conventional Reference	M13
1.3	Comparison of Future Scenarios with Reference Scenarios and Overall Summary	M30
2	Technology Analysis for Future Energy Storage, Supply and Transmission	M20
2.1	Battery Technology	M15
2.2	Fuel Cell Technology	M15
2.3	Turbine / ICE generator sets	M15
2.4	Power Electronics	M15
2.5	Electric Drives	M15
2.6	On-Ground Energy Supply	M15
3	Life Cycle Inventory Forecast & Validation	M26
3.1	Materials Processes Ressources	M22
3.2	Efficiency of Manufacture and Production	M26
3.3	Lifetime Services and MRO	M26
3.4	Recycling, Re-Use and End-of-Life	M26
3.5	Lab Scale Validation	M26

Task Description

Task 1: Basic Concepts, Requirement analysis

Task 1 will cover basic concepts from an overall performance or aircraft design perspective. Focus shall be set to a 50 pax regional class A/C concept and its requirements with regard to electric or hybrid electric propulsion. The A/C concept and its sub-systems shall be defined in a top-down approach to derive requirements and performance demands for the bottom-up driven technology analysis in Task 2.

Task 1.1: Overall Requirements for (hybrid) electric 50 pax regional class A/C

Task 1.1 will focus on the identification and/or definition of overall requirements for a 50 pax regional class hybrid/electric aircraft. Building on typical characteristics of a representative configuration in this a/c class and taking into account particular mission profiles, key specifications to be fulfilled by a hybrid/electrical powertrain shall be derived and provided as design frame for the technology analysis in Task 2. These are for instance on board energy storage, shaft power level (peak and cruise), weight (powertrain incl. energy storage system) or change-over time. Expected overall a/c performance increases resulting from future aircraft design approaches and optimized aerodynamics or enabled by electrical powertrains should be included in a suitable and reasonable manner (e.g. laminar flow, distributed propulsion, BLI, blended wing, etc.).

Task 1.2 Scenarios & Requirements for Future Hybrid Electrical Propulsion and Conventional

For hybrid electric propulsion, from today's perspective three major technology streams for energy storage may be considered as proposed in Figure 2: (i) battery based approaches, (ii) fuel-cell based approaches and (iii) approaches based on turbine /ICE propelled (kerosene or drop-in alternative fuels) generator sets, including combinations and the related on-ground energy supply. Independent of the energy storage and supply, power electronics and electric drives are relevant for energy transmission.

1.2.1) Future Scenarios and technology performance levels required for hybrid electrical A/C

Based on the three technology streams given above (i-iii), relevant scenarios for hybrid/electric A/C shall be defined for further analysis in close coordination with Task 1.1. Combined approaches of two or all three technology streams and sub-scenarios counting for distinct power/energy distributions for each of the technology streams might be considered. Following an application pull approach, for each of the selected scenarios particular requirement analysis should be conducted to derive technology performance requirement windows for each of the addressed technologies to be employed as base for the technology analysis in Task 2 (e.g. energy density demand or power density demand of the systems).

1.2.2) Reference Concepts on conventional propelled A/C

As baseline for a comparison and evaluation of the effects of future hybrid electrical aircraft scenarios relevant reference aircraft concepts shall be defined on conventional propulsion concepts (such as turbofan / turboprop). These reference concepts should include the state of the art status of today and also developments and optimization approaches on conventional propulsion expected on the Horizon of 2030+.

Task 1.3: Comparison of Future Scenarios with Reference Scenarios and Overall Summary

Based on the results of the technology analysis in Task 2 and the Life Cycle Analysis in Task 3 an overall comparison of the scenarios for hybrid electric aircraft and an evaluation of their life cycle impact compared to conventional concepts from Task 1.2 shall be carried out on overall summary level.

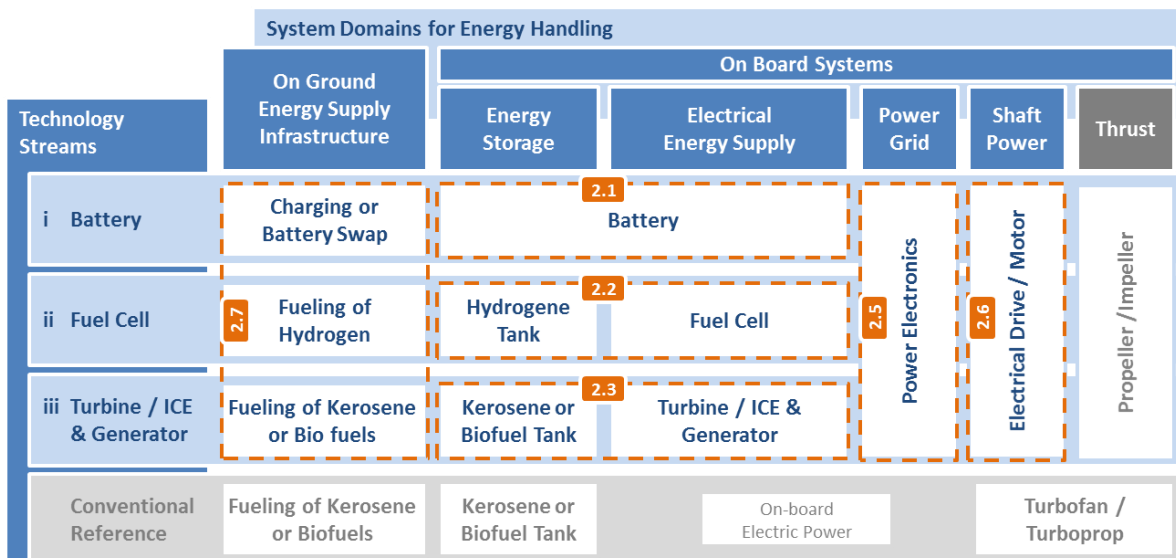

Figure 2: Assignment of technology subTasks to technology streams.

Task 2: Technology Analysis for Future Energy Storage, Supply and Transmission 2050

To realize future concepts for hybrid electric aircraft, existing technology gaps and barriers for energy storage, supply and transmission will need to be overcome. New and disruptive solutions will be required e.g. for compact and lightweight modules for electrochemical power sources, power electronics and electric drives, as well as for on ground energy supply solutions.

Based on the scenarios and the requirement analysis of Task 1 in this Task 2, a bottom-up technology analysis shall be made for the most relevant technologies with a perspective on the selected technology streams (i)-(iii) and timeframes (a)-(c). This analysis shall cover all relevant system domains for energy handling such as on board energy storage, on board supply of electrical energy, on board transmission (power grid management and shaft power output) as well as ground energy supply to aircraft. Considering the three major technology streams and the relevant system for energy handling the analysis can be structured into sub-Tasks oriented towards battery technology, fuel cell technology, technology for turbine / ICE propelled generator sets, and hybrid technologies resulting from their combination as well as power electronics, electric drives and on-ground energy supply to aircraft. The applicant may propose an alternative structure if deemed more valuable. The assignment of the Technology Tasks to the technology streams is shown below.

For each sub-Task the technology analysis shall follow a three step approach:

- Definition of the state of the art performance level (Milestone M2)
- Description of technology barriers and gaps to meet required performance levels for the proposed hybrid/electric a/c design derived in Task 1/1.2
- Potential solutions to overcome these technology barriers, gaps and approaches to reach the required performance levels for the selected timeframe a) – c), based on roadmap analysis and interpolation. Regarding the analysis in Task 3 a particular focus shall be included towards material usage and production technology.

Task 2.1: Battery Technology

The main challenge for battery technology is to reach higher energy density levels. A forecast for the energy storage density evolution of lithium-ion, lithium sulphur and lithium air battery technology shall be given. Thereby also the influence of the developments on the provided power densities shall be analysed. Furthermore the used electrolyte shall be forecasted including the option for all solid state batteries at least of the lithium ion and lithium air types. In the forecast also the evolution of charge and

discharge efficiency shall be given, which can be used to estimate the required cooling of the system in flight and during recharge whilst grounded. Finally a forecast on the battery production technology shall be given. For all forecasts, production technology developments and material usage should be included. Besides the analysis of expected costs and capacity it is also of high interest to analyse the expected quality evolution and cell failure rates as a flight battery will comprise extremely high number of cells requiring new levels of quality assurance.

Task 2.2: Fuel Cell Technology

With regard to fuel cell applications for future A/C scenarios two major aspects can be considered: the on-board storage and supply of hydrogen and the particular fuel cell technology for conversion into electrical power. Both of them shall be included in the analysis if technology stream ii) is selected.

For a 50 pax regional class hybrid electrical aircraft, it is assumed that pure hydrogen shall be considered as on-board fuel due to its high energy density. However, onboard storage of pure hydrogen is critical. Due to their complexity, on-board hydrogen storage systems will have a significantly negative impact on the overall energy density. Light tank systems for larger amounts of liquid hydrogen or cryo-compressed hydrogen are of interest, as well as future chemical hybrid storage solutions. Effects of the selected storage on fuel purity and heat demand shall be also investigated and taken into account when evaluating different fuel cell technologies. A forecast on the development of reformer technologies for sustainable fuels which can be reformed under mild conditions shall be given if deemed valuable. Here methanol derived fuels might be of particular interest.

With respect to the particular fuel cell technology the analysis shall include three fuel cell technologies (LT-PEMFC, HT-PEMFC and SOFC) which are discussed today for application in aviation. A forecast on further fuel cell technologies shall be given if deemed valuable. In particular a forecast on the development of power density of cell, stack and system level is required. Stack level forecast must thereby also take into account developments of bipolar plates and sealing technology. The system level forecast must in particular address system level constraints concerning humidification and thermal management. For all forecasts production technology developments and material usage should be included as input to Task 3.

Task 2.3: Turbine / ICE Generator Set

As a third alternative system for on board supply of electrical energy, a turbine / ICE generator set shall be considered. Future improvements shall be included as well as the overall on board fuel system. Both conventional kerosene and also alternatives such as biofuels/synthetic fuels should be taken into account.

Task 2.4: Power Electronics

New WBG materials like SiC and GaN enable power electronic systems with already today relatively high power densities. Research activities in future materials like Aluminum nitride and Diamond together with new packaging solutions promise large potential in power electronics power density improvement. The task should give a forecast on development of power electronics technologies for future hybrid/electric a/c. Based on the overall concept and system topology derived in Task 1, relevant power electronic systems for future hybrid/electric A/C should be defined, e.g. non-isolating unidirectional fuel cell DC/DC converter and bidirectional battery DC/DC converter, traction drive inverters for motors and generators, isolating DC/DC converter for low voltage supply and DC/AC grid inverter (Fig. 1). For all forecast production technology developments and material usage should be included as input to Task 3.

Task 2.5: Drives

Electric drives are available in a wide variety of topologies and technologies like synchronous and asynchronous machines or multiphase topologies. The study should evaluate technology potentials for

Task 1.2 demands based on conventional technology electric drives but might also include potentials in superconducting topologies for future hybrid/electric A/C. For all forecast production technology developments and material usage should be included.

Task 2.6: On Ground Energy Supply

Today, on-ground energy supply basically is fueling. With regard to future hybrid electrical aircraft, additional and/or alternative infrastructure will be required for on ground energy storage, grid connection and transfer to aircraft (i.e. battery charging or battery swap as well as storage, on-site generation and fueling of hydrogen or kerosene/bio fuels). Basic requirements such as energy transfer rates for the on ground energy supply to aircraft can be derived based on the energy transfer through conventional fueling processes or based on time slots for airport changeover time. For the appropriate energy supply technologies an analysis shall be conducted.

With regard to direct supply of on-ground electrical energy to aircraft technologies and topologies for ground power during service and their impact on electrical energy demand for an airport operating different numbers of hybrid/electric A/C being operated at the airport shall be included. Evaluate potentials and strategies for airport energy management during A/C service like e.g. individually controlled charging power for each A/C and inclusion of ground-based electrical energy storage to buffer load peaks. Also consider possible impact of combined ground power supply and onboard energy generation.

With regard to on ground hydrogen supply, external hydrogen supply chain solutions should be compared to on-site hydrogen generation/liquefaction at the airport, including necessary infrastructure for both cases, if technology stream ii) is selected. For all forecast production technology developments and material usage should be included as input to Task 3.

Task 3: Life Cycle Inventory Forecast & Validation

Based on the results of the technology analysis (Task 2) for the realization of future scenarios for energy storage, transmission and supply for future hybrid/electrical aircraft, the applicant shall estimate and forecast particular life cycle inventory and provide LCI-Data on required materials, processes and resources, on the production system, on material flow, on service and MRO aspects as well as on re-use and recycling approaches. Additionally, interactions with alternative sectorial applications might also be considered. As interface to CS2 ecoDESIGN Transversal Activity particular LCI Reports and a final report are foreseen as deliverables in the course of the project. Based on these LCI-Data and in the course of the ecoDESIGN analysis, Life Cycle Impact will be conducted Analysis including eco-statements and socio-economic statements. LCI-Data and analysis results will be part of the Aviation Environmental Database under ecoTA and shall meet standards given in the ILCD Handbook or in ISO 14040/14044.

The effects of future scenarios for energy storage transmission and supply for future hybrid/electric aircraft on alternative sectorial applications such as other mobility sectors, the global electric grid, or other relevant sectors should be analyzed, where appropriate. Based on the technology analysis (Task 2) provide information on how technology development may affect alternative sectorial applications - positively or negatively.

Task 3.1: Materials, Processes, Resources

Analyze materials, processes and resources required for realization of future scenarios for energy storage, transmission and supply for future hybrid/electric aircraft based on the outcome of the technology analysis (Task 2). Provide a forecast of the life cycle inventories and LCI Data of Materials Processes and Resources required to realize these scenarios (forecast of Bill of Material and Bill of Processes).

Task 3.2: Efficiency of Manufacture and Production

Analyse the production system required for realization of future scenarios for energy, storage transmission and supply for hybrid/electric aircraft based on the outcome of the technology analysis (Task 2). Provide a forecast of the process flow charts and Life Cycle Inventories for a future Production environment. Also include jobs and skills required. Analyze the material flow required in a European or global supply chain for the realization of future scenarios and include the full supply chain from extraction of raw material through manufacture and assembly of a hybrid electric aircraft up to the recycling disposal and end of life of particular components.

Task 3.3: Lifetime Services & MRO

Analyse lifetime services and MRO requirements future scenarios for energy storage, transmission and supply for future hybrid/electric aircraft based on the outcome of the technology analysis (Task 2). Provide estimated information on relevant aspects for service and MRO as well as on cycles, new to build service and MRO infrastructure and capabilities.

Task 3.4: Recycling, Re-Use and End-of-Life

Analyse Recycling and End-of-Life options in the context of future scenarios for energy storage transmission and supply for hybrid electrical aircraft 2050 based on the outcome of the technology analysis (Task 2). Provide Life Cycle Inventories and LCI-Data on recycling streams or end of life approaches.

Task 3.5: Lab scale Validation

To validate LCI-Data assumptions and estimations, lab scale testing and validation may be considered for relevant technology if possible and conductible.

4. Topic special conditions

Special conditions apply to this topic:

- **Page limit:**

The limit for a full proposal answering a Thematic Topic is **30 pages** in total, see proposal template B.I.

- **Scoring and weighting:**

For Thematic Topics: to determine the ranking, the score for the criterion 'excellence' will be given a weight of 1.5.

- **Number of winning proposals:**

Under the Thematic Topics, more than one proposal per topic may be funded.

- **Admissibility:**

Standard admissibility conditions and related requirements as laid down in Part B of the General Annex of the Work Programme shall apply mutatis mutandis with the following additional condition(s) introduced below:

- The 16 Leaders of JU listed in Annex II to Regulation n° (EU) No 558/2014 and their affiliates⁸⁶ **may not apply** to the topics listed in this call text document.

5. Abbreviations/Acronyms

LCI	Life Cycle Inventioy
ILCD	International Reference Life Cycle Data System

⁸⁶ See the definition under Article 2.1 (2) of the H2020 Rules for Participation

A/C	Aircraft
BLI	Boundary Layer Ingestion
MTOW	Maximum Take-off Weight
PAX	Passengers
DC	Direct current
AC	Alternating current
SiC	Silicon Carbide
GaN	Gallium Nitride
AlN	Aluminum Nitride
C	Diamond (Carbon)
WBG	Wide band gap
VTOL	Vertical take off and landing
CTOL	Conventional take off and landing
HT-PEMFC	high temperature polymer electrolyte membrane fuel cells
SOFC	solid oxide fuel cell
ICE	Internal combustion engine

IV. JTI-CS2-2020-CFP11-THT-14: Scalability and limitations of Hybrid Electric concepts up to large commercial aircraft

Type of action (RIA/IA/CSA):		RIA	
Programme Area:		N/A	
(CS2 JTP 2015) WP Ref.:		N/A	
Indicative Funding Topic Value (in k€):		800	
Topic Leader:	N/A	Type of Agreement:	N/A
Duration of the action (in Months):	30*	Indicative Start Date (at the earliest)⁸⁷:	> Q4 2020

**The JU considers that proposals requesting a contribution of 800k€ over a period of 30 months would allow this specific challenge to be addressed appropriately. Nonetheless, this does not preclude submission and selection of proposals requesting other amounts and/or proposing different activity durations.*

Topic Identification Code	Title
JTI-CS2-2020-CFP11-THT-14	Scalability and limitations of Hybrid Electric concepts up to large commercial aircraft
Short description	
Radical aircraft concepts with green enabled propulsion systems are being developed for several vehicles classes (small, regional and large aircraft). Certain switch points are existing were technologies are better suited to one or another class, also in the frame of different regulatory frameworks. These switching points substantially influence the requirements with respect to the main features of the aircraft architecture, with substantial effects on economic figures for the entire industrial lifecycle, also achievable reliability and safety levels. In the frame of this studies there need for different approaches or the opportunity for common approaches should be defined.	

Links to the Clean Sky 2 Programme High-level Objectives⁸⁸				
This topic is located in the demonstration area:				NA
The outcome of the project will mainly contribute to the following conceptual aircraft/air transport type as presented in the scene setter:				NA
With expected impacts related to the Programme high-level objectives:				
Reducing CO₂ emissions	Reducing NO_x emissions	Reducing Noise emissions	Improving EU Competitiveness	Improving Mobility
<input checked="" type="checkbox"/>	<input checked="" type="checkbox"/>	<input checked="" type="checkbox"/>	<input checked="" type="checkbox"/>	<input checked="" type="checkbox"/>

⁸⁷ The start date corresponds to actual start date with all legal documents in place.

⁸⁸For further info see Chapter 1 “Introduction to the Programme Scene Setter / Objectives” with key technology themes / demonstration areas. Detailed information available in the CS2 Development Plan accessible via the Clean Sky JU Website and EC Participant Portal.

1. Specific challenge

Initiated from studies purely looking at energy saving and at the potential reduction or even removal of CO₂ emission for future transport aircraft, novel propulsion systems are recently considered to change the energy carrier in the search for a more sustainable aviation future.

The expected benefit in terms of energy savings is expected to emerge to a substantial extend employing radical configurations. For hybrid electric propulsion systems, the generation of energy and thrust can be separated, enabling new concepts that for example interact with the wing tip vortex or with the high lift system.

Currently, a multitude of concepts are being investigated for several vehicle classes in parallel. A significant acceleration for the development of larger vehicles is expected when capturing and straight building upon the experience made by the development of smaller vehicles. As for example, the required key elements for a hybrid electric power train for a potential use in aviation are not yet available at any large scale, the development will subsequently move through reasonable steps, from small to big. This might also include the use of smaller vehicles as (scaled) demonstrator vehicles with a reasonable understanding on the critical features that must be considered toward a later up-scaling.

With this approach the key point to be tackled in an early stage is the definition of requirements that must be taken into account to assure proper up-scale of technologies and architectures to large units and vehicles. A focus is expected toward the very high standards of safety, operational reliability but also industrial competitiveness.

Setting the right tasks and scope, it is important to ensure, for example, that the new electric or hybrid electric technologies under development and the associated new aircraft concepts are not only suitable for general aviation aircraft, but can be adapted and applied further in Commuter Aircraft, regional aircraft, and most preferably, for large air transport. In this respect, different solutions might be pursued depending on the different requirements in certification and operating environment (vehicle speed). As example, some propulsion system architectures are better suited to certain sizes of vehicle whereas, the switch-over points between different technologies and system architectures are not yet well known. A better knowledge on the design space across vehicle classes could provide synergies between developments.

2. Scope

The objective of this topic is to systematically review the key requirements for the development of next generation key technologies like hybrid electric propulsion concepts, the use of alternative non-drop in fuels technologies (Hydrogen-H₂, Liquid Natural Gas - LNG) for the different fixed wing vehicle classes of light aircraft (General Aviation), commuter aircraft, regional aircraft, short-medium range and large passenger aircraft for the “upscaling development approach”.

The objectives of this topic can be broken down into 5 parts :

- 1) Define a vehicle scheme with Top Level Aircraft Requirements (TLAR) for each of the 5 A/C categories (light aircraft - General Aviation, commuter aircraft, regional aircraft, short-medium range and large passenger aircraft), with typical operations regime and specifications. This first part shall draw a “state of the art” picture, explaining also where the typical “switching” points are with today’s technologies and aircraft configurations. Key parameters of typical customer (passenger) expectations, aircraft operators, levels of operational reliability and safety shall be provided with reference to other recent studies.
- 2) Identify opportunities and limitations of scaling of main technologies, “switching points” with respect to the usability of specific components and systems relevant for the next generation aircraft development and aircraft configurations targeted in this study. An assessment of expected reliabilities in operation, applicability of current regulations and limits of current regulations shall be

made for these technologies.

- 3) The analysis shall be applied to a “radical” aircraft architecture of a hybrid electric fixed wing aircraft with a primary non-drop in fuel source. This architecture shall be “expanded” from a GA vehicle to a FAR 23 and a FAR25 type of aircraft with Top level aircraft requirements and operational requirements typical for each class. The aim is to explore in which way the upscaling in combination with entering the requirements of a new vehicle class and the differences in the operational profile would require substantial changes in the aircraft architecture.
- 4) Expand the analysis to the requirements for the availability of key airport infrastructures required to operate the five classes specific to the technical nature of the future radical aircraft with regards to reliable, economic and fully safe use.
- 5) With the knowledge and understanding gained through the study of the technology and architecture of the radical hybrid electric aircraft concept, an estimation of the economic and operational viability (i.e. what are the key parameters of a business case, what are the key operational constraints for passenger and airline, both compared with a typical scenario of today) shall be made for the case of the Commuter, regional aircraft and short and medium large transport aircraft. This estimate shall be made by comparing the achievable features of these aircraft assuming up-scaling will be conducted to the largest scale up to TRL 6 until 2030.

These five parts of the objectives are deemed to provide a fair fundamnet for a work package structure of the project plus a work package for management and one work package to manage dissemination, communication and exploitation.

3. Expected outcomes/impact

The following main tasks shall be taken as backbone to propose the planning of the project.

At the end of the project answers to following important questions shall be part of the outcome:

- What are the key risks and challenges for “hybrid electric radical architecture” fixed wing aircraft developing the main technologies by “up-scaling” over a wide range of vehicle sizes?
- Which parts of the regulations FAR23 and FAR 25 are of particular relevance for the chosen “upscaling development” approach for technologies and architectures. Which part of future hybrid electric radical aircraft development considered as critical is not tackled?
- Which are the key requirements of infrastructure around the aircraft operation that must be considered when scaling technologies?

Tasks		
Ref. No.	Title - Description	Due Date
T-01	Establishment of a scheme of five reference vehicles representing a typical aircraft from GA, Commuter, Regional Aircraft, Short and medium range large passenger aircraft with simplified state of the art technologies and aircraft architecture. Establishment of representative cases of aircraft operations for each vehicle class	T0 + 6M
T-02	Establishment of a table of radical aircraft target technology to be implemented at small aircraft level (GA) then to be developed by upscaling	T0+ 10M
T-03	Identification of KPIs / key criteria to measure / assess during the project. Create a reference case for the economic and operational viability study	T0 + 10M

Tasks		
Ref. No.	Title - Description	Due Date
T-04	Compile, compute and analyse data for key target technologies (hybrid electric propulsion, non-drop in fuel, autonomous flight) with respect to the scaling required to fit into short-medium range large passenger aircraft. Cross check with requirements of currently valid regulations. Identification of limits and switching points.	T0 + 18M
T-05	Establish complementary requirements with respect to architecture around the aircraft (airport, fuel, batterie, part supply, other ground support, essential navigation aids and equipment)	T0 +21M
T-06	Identification of important cross-over points for system architectures and technology approaches and potential consequences for requirements on infrastructure and operation.	T0 + 21M
T-07	Analysis and discussion of potential impact on certification and requirements impact. This should specifically contain considerations on how to achieve large transport aircraft safety for regional and commuter aircraft without simply copy and pasting all regulatory requirements.	T0 + 26M
T-08	Assess the economic and operational viability of the radical hybrid-electric aircraft concept for the vehicle classes Commuter, Regional Aircraft and Short and Medium Range large commercial aircraft. Use the assumption made for the opportunities and limitations of the up-scaling development and the requirements and limitations derived.	T0 + 28M
T-09	Propose opportunities of additional synergies of cross vehicle class development – not yet considered in “up-scaling development”	T0 + 30M

4. Topic special conditions

Special conditions apply to this topic:

- **Page limit:**

The limit for a full proposal answering a Thematic Topic is **30 pages** in total, see proposal template B.I.

- **Scoring and weighting:**

For Thematic Topics: to determine the ranking, the score for the criterion ‘excellence’ will be given a weight of 1.5.

- **Number of winning proposals:**

Under the Thematic Topics, more than one proposal per topic may be funded.

- **Admissibility:**

Standard admissibility conditions and related requirements as laid down in Part B of the General Annex of the Work Programme shall apply mutatis mutandis with the following additional condition(s) introduced below:

- The 16 Leaders of JU listed in Annex II to Regulation n° (EU) No 558/2014 and their affiliates⁸⁹ **may not apply** to the topics listed in this call text document.

⁸⁹ See the definition under Article 2.1 (2) of the H2020 Rules for Participation